

## **General Notice**

When using this document, keep the following in mind:

1. This document is confidential. By accepting this document you acknowledge that you are bound by the terms set forth in the non-disclosure and confidentiality agreement signed separately and /in the possession of SEGA. If you have not signed such a non-disclosure agreement, please contact SEGA immediately and return this document to SEGA.
2. This document may include technical inaccuracies or typographical errors. Changes are periodically made to the information herein; these changes will be incorporated in new versions of the document. SEGA may make improvements and/or changes in the product(s) and/or the program(s) described in this document at any time.
3. No one is permitted to reproduce or duplicate, in any form, the whole or part of this document without SEGA'S written permission. Request for copies of this document and for technical information about SEGA products must be made to your authorized SEGA Technical Services representative.
4. No license is granted by implication or otherwise under any patents, copyrights, trademarks, or other intellectual property rights of SEGA Enterprises, Ltd., SEGA of America, Inc., or any third party.
5. Software, circuitry, and other examples described herein are meant merely to indicate the characteristics and performance of SEGA'S products. SEGA assumes no responsibility for any intellectual property claims or other problems that may result from applications based on the examples describe herein.
6. It is possible that this document may contain reference to, or information about, SEGA products (development hardware/software) or services that are not provided in countries other than Japan. Such references/information must not be construed to mean that SEGA intends to provide such SEGA products or services in countries other than Japan. Any reference of a SEGA licensed product/program in this document is not intended to state or simply that you can use only SEGA'S licensed products/programs. Any functionally equivalent hardware/software can be used instead.
7. SEGA will not be held responsible for any damage to the user that may result from accidents or any other reasons during operation of the user'S equipment, or programs according to this document.

NOTE: A reader's comment/correction form is provided with this document. Please address comments to :

SEGA of America, Inc., Developer Technical Support (att. Evelyn Merritt)  
150 Shoreline Drive, Redwood City, CA 94065

SEGA may use or distribute whatever information you supply in any way it believes appropriate without incurring any obligation to you.



SEGA OF AMERICA, INC.  
Consumer Products Division

SEGA Confidential

# **VDP2 User's Manual**

**Version 1.1**

Doc. #ST-58-R2-060194

## READER CORRECTION/COMMENT SHEET

### Keep us updated!

If you should come across any incorrect or outdated information while reading through the attached document, or come up with any questions or comments, please let us know so that we can make the required changes in subsequent revisions. Simply fill out all information below and return this form to the Developer Technical Support Manager at the address below. Please make more copies of this form if more space is needed. Thank you.

### General Information:

Your Name \_\_\_\_\_ Phone \_\_\_\_\_

Document number ST-58-R2-060194 Date \_\_\_\_\_

Document name VDP2 User's Manual

### Corrections:

Chpt.	pg. #	Correction

Questions/comments: \_\_\_\_\_

\_\_\_\_\_

\_\_\_\_\_

\_\_\_\_\_

### Where to send your corrections:

Fax: (415) 802-3963  
Attn: Manager,  
Developer Technical Support

Mail: SEGA OF AMERICA  
Attn: Manager,  
Developer Technical Support  
275 Shoreline Dr. Ste 500  
Redwood City, CA 94065

## REFERENCES

In translating/creating this document, certain technical words and/or phrases were interpreted with the assistance of the technical literature listed below.

1. *KenKyusha New Japanese-English Dictionary*  
1974 Edition
2. *Nelson's Japanese-English Character Dictionary*  
2nd revised version
3. *Microsoft Computer Dictionary*
4. *Japanese-English Computer Terms Dictionary*  
Nichigai Associates  
4th version

# Preface

This manual describes the VDP2 (Video Display Processor 2) and how to use it. The VDP2 controls the scroll screen control and the display priority control.

## Manual Notations

Notations within this manual are described below.

### Binary, hexadecimal

Binary notation has a B attached at the end (as in 100B); however, B may be omitted when binary notation is obvious. Hexadecimal notation has an H attached at the end (as in 00H and FFH).

### Units

1 Kbyte is 1024 bytes. 1 Mbit is 1024 Kbits, or 1,048,576 bits.

### MSB, LSB

The structure of byte and word shows the MSB (most significant bit) on the left and LSB (least significant bit) on the right.

### An undefined bit

A bit not defined by the register is shown as a dash. A "0" should be written into an undefined bit of the register. Bits not defined by data of tables defined by VRAM are shown as shaded. As a rule, a 0 should be written, providing that the undefined bit is ignored.

### Byte, word, bit

Bits, as in digits of 0 and 1, are the lowest unit of data. A byte consists of 8 bits. A word consists of 2 bytes, and begins from an even address.

### Boundary

A boundary defines data from an address divisible by a selected value. For example, data for a 20H-byte boundary is defined at addresses beginning from 20H, 40H, and so on. A word is a 2-byte boundary.

### Address

All addresses defined by VDP2 are relative addresses within VDP2. The first address of VDP2 begins from 5E00000H. For example, VRAM is at 000000H address of the relative address, and begins from 5E00000H address of the absolute address. The TV screen mode register is at 180000H address of the relative address, and is set at address 5F80000H of the absolute address.

## Manual Structure

The main items described in each chapter are as follows.

**Table 1. Chapters and Main Items**

Chapter Name	Contents
Chapter 1 VDP2 Functions	VDP2 Functions
Chapter 2 TV Screen	TV Screen Mode, Normal, Hi-Res, Exclusive Monitor, Interlace Mode, External Signal,-H Counter, V-Counter, Exclusive Hi-Res Setting
Chapter 3 RAM	VRAM Size, Address Map, VRAM, Color RAM, Register, VRAM Change, VRAM Bank Partition, VRAM Access Method, Color RAM Mode
Chapter 4 Scroll Screen	Cell, Character Color Count, Transparent Dot, Character Pattern, Pattern Name Table, Special Function Bit, Reverse Function Bit, Page, Plane, Map, Bitmap, Screen-Over Process, Mosaic Process
Chapter 5 Normal Scroll Screen	Screen Scroll, Scaling, Line Scroll, Vertical Cell Scroll Coordinates
Chapter 6 Rotation Scroll Screen	Rotation Scroll Increment, Rotation Scroll Screen Display, Rotation Parameter Coefficient Table
Chapter 7 Line Screen	Line Color Screen, Back Screen
Chapter 8 Window	Normal Rectangular Window, Normal Line Window, Sprite Window
Chapter 9 Sprite Data	Sprite Type, Sprite Color Mode, Priority, Color Calculation
Chapter 10 Dot Color Data	Palette Format, RGB Format, Sprite Dot, Scroll Dot, Special Function Code
Chapter 11 Priority Function	Priority Number, Line Color Screen Insertion
Chapter 12 Color Calculation	Color Calculation, Extended Color Calculation, Special Color Calculation, Gradation Calculation
Chapter 13 Color Offset Function	Color Offset
Chapter 14 Shadow Function	Normal Shadow, MSB Shadow
Chapter 15 How To Use VDP2	Operation Flow Chart, How to use RAM, Bit Structure

**Table 2. Functions, their chapters and sections**

Function	Details		Chapter		
Overview	~		1	VDP2 Functions	
TV Screen	TV Screen Configuration, Designate Display Area, Boarder Area		2.1	TV Screen Configuration	
	TV Screen Mode, Normal, Hi-Res, Exclusive Monitor		2.2	TV Screen Mode	
	Interlace, Non-interlace, Single-Density Interlace, Double-Density Interlace		2.3	Interlace Mode	
RAM	Address Map		3.1	Address Map	
	VRAM	Size	3.1	Address Map	
		Change	3.2	VRAM Change	
		Bank Partition	3.3	VRAM Bank Partition	
		Access During Display	3.4	How to Access VRAM During Display	
Color RAM Mode		3.5	Color RAM Mode		
Scroll Screen	Normal Scroll Screen Rotation Scroll Screen	Screen Display		4.1	Screen Display Control
		Color	Character Color Count Bitmap Color Count	4.3	Cell
			Palette Format Dot Color Data	10.1	Palette Format Dot Color Data
			RGB Format Dot Color Data	10.2	RGB Format Dot Color Data
			Color RAM Mode	3.5	Color RAM Mode
		Cell Format	Cell	4.3	Cell
			Character Pattern	4.4	Character Pattern
			Pattern Name Table (Page)	4.6	Pattern Name Table (Page)
			Plane	4.7	Plane
			Map	4.8	Map
		Bitmap Format		4.9	Bitmap
		Display Area, Screen-Over		4.10	Display Area
		Mosaic Process		4.11	Mosaic Process
		Screen Scroll Function		5.1	Screen Scroll Function
		Scale Function		5.2	Scale Function
		Line Scroll Function, Vertical Cell Scroll Function		5.3	Line & Vertical Cell Scroll Function

**Table 2. Functions, their chapters and sections (continued)**

Function	Details		Chapter	
Scroll Screen	Rotation	Coordinates Calculation	6.1	Rotation Scroll Coordinates Calculation
		Display Control	6.2	Rotation Scroll Screen Display Control
	Scroll Screen	Rotation Parameter Control	6.3 8	Rotation Parameter Control Window
		Coefficient Control	6.4	Coefficient Table Control
	Line Screen	Line Color Screen	7.1 6.4 11.3	Line Color Screen Coefficient Table Control Line Color Screen Insertion
Back Screen		7.2	Back Screen	
Window	Normal Rectangular Window, Normal Line Window, Sprite Window, Window Effective Area		8 9.1	Window Sprite Data
Sprite	Sprite Data, Type, Color Mode		9.1	Sprite Data
	Priority and Color Calculation		9.2	Priority and Color Calculation
	Sprite Window		8 9.1	Window Sprite Data
	Dot Color	Palette Format	10.1	Palette Format Dot Color Data
	Data	RGB Format	10.2	RGB Format Dot Color Data
Color RAM Mode		3.5	Color RAM Mode	
Priority	Priority Function		11.1 9.2	Priority Function Priority and Color Calculation
	Special Priority Function		11.2 10.3	Special Priority Function Special Function Code
	Line Color Screen Insertion		11.3 7.1	Line Color Screen Insertion Line Color Screen
	Color	Color Calculation Function, Extended Color Calculation Function		12.1 7.1
Special Color Calculation Function		12.3 10.3	Special Color Calculation Function Special Function Code	
Gradation Calculation Function		12.2	Gradation Calculation Function	
Color Calculation Window		8	Window	
Color Offset Function		13	Color Offset Function	
Shadow	Normal Shadow, MSB Shadow		14 9.1	Shadow Function Sprite Data



# Table of Contents

Preface .....	i
Manual Notation .....	i
Manual Structure .....	iii
List of Figures .....	xi
List of Tables .....	xiv
Chapter 1 VDP2 Functions .....	1
Introduction .....	2
1.1 System Configuration .....	2
1.2 Address Map .....	3
VRAM .....	3
Color RAM .....	3
Register .....	4
1.3 Scroll Function .....	5
Display Screen .....	5
Scroll Screen .....	6
Line Screen .....	7
Windows .....	7
1.4 Priority Function .....	8
Priority Function .....	8
Color Calculation Function .....	8
Color Offset Function .....	8
Shadow Function .....	9
Chapter 2 TV Screen .....	11
2.1 TV Screen Mode .....	12
Special High Resolution Graphic Mode .....	13
2.2 Interlace Mode .....	14
2.3 TV Screen Structure .....	15
2.4 TV Screen Mode Register .....	16
2.5 External Signals and Scan Conditions .....	19
External Signal Enable Register .....	19
Screen Status Register .....	21
H Counter Register .....	23
V Counter Register .....	24
Chapter 3 RAM .....	25
Introduction .....	26
3.1 Address Map .....	26
VRAM Size Register .....	28
3.2 VRAM Bank Partitioning .....	29
RAM Control Register .....	29
3.3 Accessing VRAM During Display Interval .....	31
VRAM Access During Display Interval .....	31
Image Data Access .....	32
Vertical Cell Scroll Table Data Access .....	35
Read/Write Access by the CPU .....	35
VRAM Cycle Pattern Selection Process .....	37

VRAM Cycle Pattern Register .....	39
3.4 Color RAM Mode .....	43
RAM Control Register .....	45
Chapter 4 Scroll Screen .....	47
4.1 Screen Display Control .....	48
Screen Display Enable Register .....	48
4.2 Scroll Screen Structure .....	50
Cell Format .....	50
Bit Map Format .....	52
4.3 Cell .....	53
Character Color Number .....	53
Cell Data Configuration .....	53
Transparent Dots .....	57
RGB Format Dot Data .....	58
4.4 Character Patterns .....	59
Character Size and Cell Arrangement .....	59
4.5 Character Control Register .....	60
4.6 Pattern Name Table (Page) .....	64
Pattern Name Table Data Configuration .....	64
Pattern Name Data .....	69
Character Number .....	74
Palette Number .....	74
Special Function Bit .....	74
Reverse (Flip) Function Bit .....	75
Pattern Name Control Register .....	76
4.7 Planes .....	79
Plane Size .....	79
Plane Size Register .....	80
4.8 Maps .....	82
Map Selection Register .....	82
Map Size .....	84
Map Offset Register .....	85
Normal Scroll Screen Map Register .....	87
Rotation Scroll Surface Map Register .....	89
4.9 Bit Maps .....	93
Bit Map Size .....	93
Bit Map Color Number .....	93
Bit Map Pattern .....	95
Bit Map Palatte Number .....	111
Special Function Bit .....	111
Bit Map Palatte Number Register .....	112
4.10 Display Area .....	114
Display Area .....	114
Screen-Over Process .....	115
Display-Over Pattern Name .....	115
Screen-Over Pattern Name Register .....	116
4.11 Mosaic Process .....	117
Mosaic Control Register .....	118

Chapter 5 Normal Scroll Screen .....	121
Introduction .....	122
5.1 Screen Scroll Function .....	122
Screen Scroll Value Register .....	123
5.2 Expansion/Contraction Function .....	126
Coordinate Increment Register .....	127
Reduction Enable Register .....	129
5.3 Line and Vertical Cell Scroll Function .....	131
Line Scroll Function .....	131
Vertical Cell Scroll Function .....	134
Line and Vertical Cell Scroll Control Register .....	137
Line Scroll Table Address Register .....	140
Vertical Cell Scroll Table Address Register .....	141
 Chapter 6 Rotation Scroll Screen .....	 143
Introduction .....	144
6.1 Rotation Scroll Coordinate Operation .....	144
6.2 Rotation Scroll Screen Display Control .....	148
RAM Control Register .....	148
6.3 Rotation Parameter Control .....	151
Data Configuration of the Rotation Parameter Table .....	153
Rotation Parameter Table .....	155
Rotation Parameter Read Control Register .....	157
Rotation Parameter Table Address Register .....	158
Rotation Read Out of the Frame Buffer .....	159
Rotation Parameter Change .....	160
Rotation Parameter Mode Register .....	162
6.4 Coefficient Table Control .....	163
Line Color Screen Data .....	164
Bit Configuration of Coefficient Table Data .....	165
Coefficient Table Lead Address .....	165
Most Significant Bit of Coefficient Data .....	166
RAM Control Register .....	167
Coefficient Table Control Register .....	168
Coefficient Table Address Offset Register .....	170
 Chapter 7 Line Screen .....	 171
Introduction .....	172
7.1 Line Color Screen .....	172
Line Color Screen Table Address Register .....	174
7.2 Back Screen .....	175
Back Screen Table Address Register .....	176
 Chapter 8 Windows .....	 179
8.1 Window Area .....	180
Normal Rectangular Window .....	180
Window Position Register .....	181
Normal Line Window .....	184
Line Window Table Address Register .....	186
Sprite Window .....	187

Sprite Control Register .....	188
Window's Active Area for the Screen .....	189
8.2 Window Process .....	190
Window Control Register .....	193
Chapter 9 Sprite Data .....	199
9.1 Sprite Data .....	200
Sprite Types .....	200
Sprite Color Mode .....	203
9.2 Priority and Color Calculation .....	204
Priority Number Selection .....	204
Color Calculation Enable Conditions .....	205
Color Calculation Ratio Selection .....	206
Sprite Control Register .....	207
Priority Number Register .....	209
Color Calculation Ratio Registers .....	210
Chapter 10 Pixels .....	213
Introduction .....	214
10.1 Palette Format Pixels .....	214
Sprite Dot Pixels .....	214
Scroll Dot Pixels .....	216
Color RAM Address Offset Register .....	217
10.2 RGB Format Pixels .....	218
Sprite Pixels .....	218
Scroll Pixels .....	218
10.3 Special Function Code .....	220
Special Function Code Select Register .....	221
Special Function Code Register .....	222
Chapter 11 Priority Function .....	223
Introduction .....	224
11.1 Priority Function .....	224
Priority Number .....	224
Priority Number Register .....	225
11.2 Special Priority Function .....	227
Special Priority Mode Register .....	229
11.3 Insertion of Line Color Screen .....	230
Line Color Screen Enable Register .....	231
Chapter 12 Color Calculations .....	233
Introduction .....	234
12.1 Color Calculation Function .....	234
Normal Color Calculation .....	234
Extended Color Calculation Function .....	236
12.2 Gradation Calculation Function .....	238
Color Calculaton Control Register .....	240
Color Calculation Ratio Register .....	243
12.3 Special Color Calculation Function .....	245
Special Color Calculation Mode Register .....	247

Chapter 13 Color Offset Function .....	249
Introduction .....	250
13.1 Color Offset Selection .....	250
Color Offset Enable Register .....	251
Color Offset Select Register .....	252
Color Offset Register .....	253
Chapter 14 Shadow Function .....	255
Introduction .....	256
14.1 Shadow Process .....	256
Normal Shadow .....	256
MSB Shadow .....	258
Shadow Control Register .....	259
Chapter 15 How to Use VDP2 .....	261
15.1 Operation Flow .....	262
15.2 How to Use RAM .....	264
15.3 Bit Configuration Map .....	267
Chapter 16 Quick Reference .....	295
16.1 Register Map .....	296
16.2 Register Bit List .....	315
16.3 Register Bit Functions .....	328
16.4 Table List .....	389

# Table of Figures

## Chapter 1 VDP2 Functions

Figure 1.1 System Configuration .....	2
Figure 1.2 Address Map .....	3

## Chapter 2 TV Screen

Figure 2.1 Display Method by Interlace Setting .....	14
Figure 2.2 TV Screen Structure .....	15

## Chapter 3 RAM

Figure 3.1 Different Capacities of VRAM Address Map .....	27
Figure 3.2 VRAM Cycle Pattern Register .....	32
Figure 3.3 Access Selection Limits of Pattern Name Table Data .....	33
Figure 3.4 Example of Character Pattern Data Read Access Selection .....	34
Figure 3.5 Access Select Limits of Vertical Cell Scroll Table Data .....	35
Figure 3.6 CPU Read/Write Access Selection when VRAM is not Divided into Two Bank .....	36
Figure 3.7 CPU Read/Write Access Selection when VRAM is Divided into Two Banks .....	37
Figure 3.8 VRAM Cycle Pattern Selection .....	39
Figure 3.9 Color Data Configuration on Color RAM .....	44
Figure 3.10 Color Data of the Color RAM .....	45

## Chapter 4 Scroll Screen

Figure 4.1 Scroll Screen Configuration of Cell Format .....	50
Figure 4.2 Scroll Screen Configuration of Cell Format and Corresponding Data Settings .....	51
Figure 4.3 Scroll Screen Configuration of Bit Map Format .....	52
Figure 4.4 Relationship of bit map format scroll screen and data settings .....	52
Figure 4.5 Configuration of Cells by Character Color Count .....	54
Figure 4.6 RGB Format Dot Data .....	58
Figure 4.7 Cell Arrangement by Character Size .....	59
Figure 4.8 Data Configuration of Pattern Name Tables .....	65
Figure 4.9 Bit Configuration when Pattern Name Data is 2 Word .....	69
Figure 4.10 Configuration when Pattern Name Data is 1 Word .....	71
Figure 4.11 Dot Color Data by Character Number of Colors .....	74
Figure 4.12 Reverse Display of Character Patterns .....	75
Figure 4.13 Arrangement of Pattern Name Table by Plane Size .....	79
Figure 4.14 Map Selection Register .....	82
Figure 4.15 Map Size .....	84
Figure 4.16 Plane Arrangement of Map by Reduction Settings .....	85
Figure 4.17 Bit Map Pattern Configuration .....	96
Figure 4.18 Dot Color Data by Bit Map Number of Colors .....	111
Figure 4.19 Mosaic Pattern .....	117

Chapter 5 Normal Scroll Screen	
Figure 5.1 Screen Scroll Value Bit Configuration .....	122
Figure 5.2 Configuration of Coordinate Increment Register .....	126
Figure 5.3 Line Scroll Function .....	131
Figure 5.4 Bit Configuration of Line Scroll Table Data .....	132
Figure 5.5 Line Scroll Table .....	133
Figure 5.6 Vertical Cell Scroll Function .....	134
Figure 5.7 Data Configuration on Vertical Cell Scroll Table .....	135
Figure 5.8 Vertical Cell Scroll Table .....	136
Chapter 6 Rotation Scroll Screen	
Figure 6.1 Rotation Scroll Screen Display Method .....	145
Figure 6.2 Rotation Parameter data Configuration .....	153
Figure 6.3 Rotation Parameter Table .....	156
Figure 6.4 How to Store to the Rotation Parameter Table VRAM .....	157
Figure 6.5 Rotation Parameter Change .....	161
Figure 6.6 Line Color Screen Data Using Coefficient Data .....	164
Figure 6.7 Bit Configuration of Coefficient Table Data .....	165
Chapter 7 Line Screen	
Figure 7.1 Line Screen .....	172
Figure 7.2 Configuration of Line Color Screen Table .....	173
Figure 7.3 Bit Configuration of Line Color Screen Table Data .....	173
Figure 7.4 Configuration of Back Screen Table .....	175
Figure 7.5 Bit Configuration of Back Screen Table Data .....	176
Chapter 8 Windows	
Figure 8.1 Normal Rectangle Window .....	180
Figure 8.2 Normal Line Window .....	184
Figure 8.3 Bit Configuration of Normal Line Window Table Data .....	184
Figure 8.4 Configuration of Normal Line Window Table .....	185
Figure 8.5 Sprite Window .....	187
Figure 8.6 Active Area of Windows .....	189
Figure 8.7 Window Process .....	191
Chapter 9 Sprite Data	
Figure 9.1 Sprite Types .....	201
Chapter 10 Dot Color Data	
Figure 10.1 Palette Format Sprite Dot Color Data .....	215
Figure 10.2 Sprite Color RAM Address .....	215
Figure 10.3 Palette Format Scroll Dot Color Data .....	216
Figure 10.4 Scroll Color RAM Address .....	216
Figure 10.5 RGB Format Sprite Dot Color Data .....	218
Figure 10.6 RGB Format Scroll Dot Color Data .....	219
Figure 10.7 Dot Color Code Corresponding to Special Function Code .....	220

Chapter 11 Priority Function	
Figure 11.1 Priority Function .....	224
Figure 11.2 Line Color Screen Insertion .....	230
Chapter 12 Color Operations	
Figure 12.1 Color Calculation Function .....	234
Figure 12.2 Color Calculation Ratio Mode .....	236
Figure 12.3 Expand Color Operation Function .....	237
Figure 12.4 Gradation Calculation Function .....	239
Chapter 13 Color Offset Function	
Figure 13.1 Color Offset Data .....	250
Chapter 14 Window Function	
Figure 14.1 Shadow Function .....	256
Figure 14.2 Sprite Data Write of a Normal Shadow .....	257
Figure 14.3 Sprite Data of a Normal Shadow .....	257
Figure 14.4 Sprite Shadow and Transparent Shadow .....	258
Figure 14.5 Sprite Data of MSB Shadow .....	259



## List of Tables

Chapter 1 VDP2 Functions	
Table 1.1 TV Screen Mode .....	5
Table 1.2 Scroll Screen .....	5
Table 1.3 Windows .....	6
Table 1.4 Scroll Screen Function .....	6
Chapter 2 TV Screen	
Table 2.1 TV Screen Mode .....	12
Table 2.2 Register for Setting the External Screen .....	21
Table 2.3 H Counter Register Bit Content .....	24
Table 2.4 V Counter Register Bit Content .....	24
Chapter 3 RAM	
Table 3.1 Data Defined in VRAM .....	26
Table 3.2 Access Numbers of Required Pattern Name Table Data during 1 Cycle .....	33
Table 3.3 Character Pattern Data (Bit Map Pattern Data) Read Access Number .....	34
Table 3.4 Character Pattern Data Read Access Selection Limits .....	34
Table 3.5 Access Command .....	40
Chapter 4 Scroll Screen	
Table 4.1 Character Color Count and Dot Data Size .....	53
Table 4.2 Cell Data Configuration .....	53
Table 4.3 Transparent Dot Data Values .....	58
Table 4.4 Pattern Name Table Capacity Page Boundary of One Page .....	64
Table 4.5 Character Number Auxiliary Mode .....	69
Table 4.6 Bit Configuration when Pattern Name Table is 1 Word .....	70
Table 4.7 Reverse Function Bit .....	75
Table 4.8 Address Value of Map Designation Register by Setting .....	83
Table 4.9 Bit Map Size .....	93
Table 4.10 Bit Map Color Count .....	94
Table 4.11 Bit Map Pattern Capacity per Surface .....	95
Table 4.12 Normal Scroll Screen Display Area .....	114
Table 4.13 Rotation Scroll Screen Display Area .....	114
Chapter 5 Normal Scroll Screen	
Table 5.1 Horizontal Coordinate Increment and Reduction Setting .....	128
Table 5.2 Display Screen Limits by Setting of Reduction Enable Bit .....	130
Chapter 6 Rotation Scroll Screen	
Table 6.1 Rotation Scroll Screen .....	144
Table 6.2 Rotation Parameters .....	151
Table 6.3 Lease significant bit of Coefficient Parameter Data Showing the Address Value Separate from Coefficient Parameter Data Size .....	166
Table 6.4 Image Processing using RGB0 Coefficient Data MGB Value. ....	167

Chapter 8 Windows	
Table 8.1 Bit Content of Window Position Register for Horizontal Coordinates. ....	182
Table 8.2 Bit Content of Window Position Register for Vertical Coordinates. ....	183
Chapter 9 Sprite Data	
Table 9.1 Shared Bits .....	200
Table 9.2 Selection of Sprite Priority Number Register .....	204
Table 9.3 Selection of Sprite Color Calculation Ratio Register .....	206
Chapter 11 Priority Function	
Table 11.1 Priority when the Priority Numbers are Equal .....	225
Table 11.2 Special Priority Function by Mode .....	228
Chapter 12 Color Operation	
Table 12.1 Color Operation Function when in High Resolution Mode or Special Monitor Mode .....	236
Table 12.2 Expanded Color Calculation Ratio.....	238
Table 12.3 Special Color Calculation Mode .....	246
Chapter 15 Method of Using VDP2	
Table 15.1 Register Connected with Data Defined in VRAM .....	265

# Chapter 1 VDP2 Functions

Introduction .....	2
1.1 System Configuration .....	2
1.2 Address Map .....	3
VRAM .....	3
Color RAM .....	3
Register .....	4
1.3 Scroll Function .....	5
Display Screen .....	5
Scroll Screen .....	6
Line Screen .....	7
Windows .....	7
1.4 Priority Function .....	8
Priority Function .....	8
Color Calculation Function .....	8
Color Offset Function .....	8
Shadow Function .....	9

## Introduction

VDP2 has a scroll and priority function. The scroll function defines the scroll screen, moves the screen up, down, right, left, and rotates the screen. The priority function prioritizes the display of multiple scroll screens, sprites, and external screens. It also processes the images in operations such as color calculation and color offset.

### 1.1 System Configuration

VDP2 is connected to 4 Mbit or 8 Mbit VRAM and contains 32K bits of color RAM. Image data is defined in the VRAM and color RAM from the CPU via the SCU. Image display controlling information is set by each register in the same way. Data defined by VRAM is read according to the setting of the register, then becomes the image data of each scroll screen. Image data of each scroll screen and sprite image data received from VDP1, as well as the external image data received from outside, become image display data. Display priority is decided by the register setting. When display image data is in a palette format, color data defined in the color RAM according to that value is read and displayed. When display image data is in the RGB format, it is shown as is. In this way, the acquired display color data is output to the display device. The VDP2 system configuration is shown in Figure 1.1.

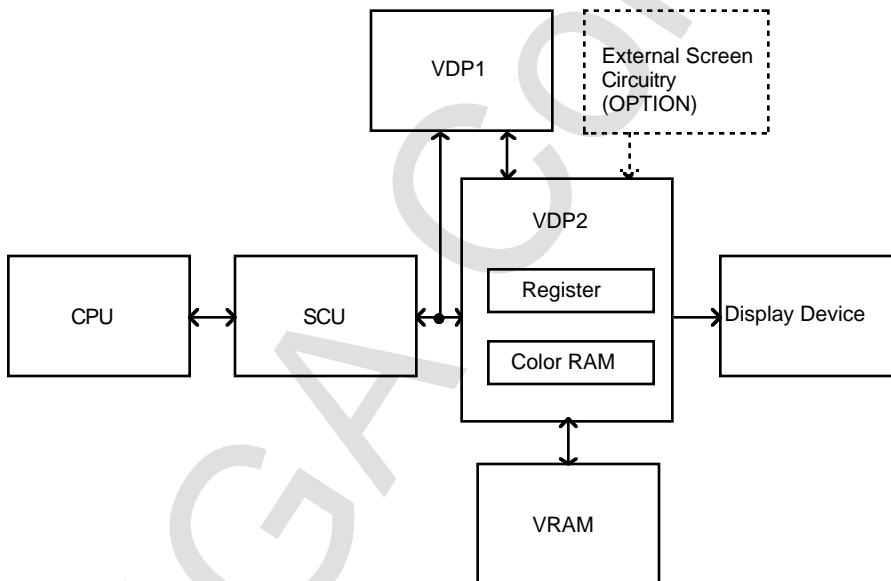

Figure 1.1 System Configuration



## 1.2 Address Map

In order to define pattern name tables and character pattern data, VDP2 is connected to two VRAMs. VDP2 contains 32K bits of color RAM for defining color data, and together with internal registers control VRAM. Figure 1.2 shows VDP2 controlled VRAM, color RAM, and register address maps.

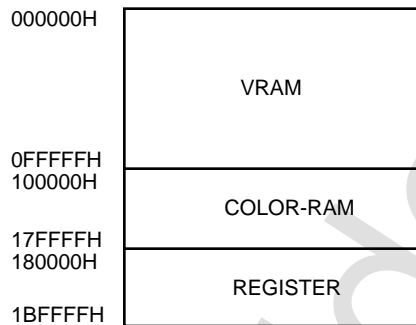

Figure 1.2 Address Map

### VRAM

VRAM stores scroll screen image data and data tables needed in each function. Read access by VDP2 is always given priority over read/write access through the CPU or DMA controller. Consequently, the wait cycle enters the CPU or DMA controller through the access timing. Access through the CPU or DMA controller is possible in units of byte, word, and long word.

### Color RAM

Color RAM stores color data of sprites and scroll screens. It also defines the enable bit of the color calculation function as it applies to the most significant bit when necessary. Read/write access from the CPU or DMA controller is possible, but the image may be disturbed by the access timing. Access through the CPU or DMA controller is possible only in word units and long word units. Access in bytes is not allowed.

## Register

Registers set each VDP2 function. Because the values of most registers are cleared to 0 after power on or reset, the values must be set. Read/write access from the CPU or DMA controller is always possible, but the image may be poor due to the access timing. Access by the CPU or DMA controller is possible only in word units and long word units. Access in bytes is not allowed.

SEGA Confidential



### 1.3 Scroll Function

The VDP2 scroll function has a scroll screen and a window.

#### Display Screen

The TV screen mode has the following characteristics.

**Table 1.1 TV Screen Mode**

TV Screen Mode	Graphic Mode	Horizontal Resolution (Pixels)	Vertical Resolution (Pixels)	Display Device
Normal	Normal Graphic A	320	224	NTSC Format or PAL Format TV
	Normal Graphic B	352	240	
Hi-Res	Hi-Res Graphic A	640	256	
	Hi-Res Graphic B	704	selection	
Exclusive Monitor	Exclusive Normal Graphic A	320	480	31kHz Monitor
	Exclusive Normal Graphic B	352	480	Hi-Vision Monitor
	Exclusive Hi-Res Graphic A	640	480	31kHz Monitor
	Exclusive Hi-Res Graphic B	704	480	Hi-Vision Monitor

The scroll screen which can be displayed has the following characteristics.

**Table 1.2 Scroll Screen**

Scroll Screen Name	Name	Remarks
Normal Scroll Screen	Normal Scroll 0	NBG0
	Normal Scroll 1	
	Normal Scroll 2	NBG2
	Normal Scroll 3	
Rotation Scroll Screen	Rotation Scroll 0	RBG0
	Rotation Scroll 1	
Line Screen	Line Color Screen	LNCL
	Back Screen	BACK
Expandable Screen	External Input Screen	EXBG

The following windows exist:

**Table 1.3 Windows**

Window Name	Name	Remarks
Normal Window	W0	Line Window allowed
	W1	
Sprite Window	SW	Sprite Character Window

### Scroll Screen

The functions of the scroll screen are listed in the table below.

**Table 1.4 Scroll Screen Function**

Function	Normal Scroll Screen				Rotation Scroll Screen	
	NBG0	NBG1	NBG2	NBG3	RBG0	RBG1
Character Color Count	16 colors 256 colors 2048 colors 32,768 colors 16,770,000 colors selection	16 colors 256 colors 2048 colors 32,768 colors selection	16 colors 256 colors selection	16 colors 256 colors selection	16 colors 256 colors 2048 colors 32,768 colors 16,770,000 colors selection	16 colors 256 colors 2048 colors 32,768 colors 16,770,000 colors selection
Character Size	1 Cell H x 1 Cell V; 2 Cells H x 2 Cells V					
Pattern Name Data Size	1 Word, 2 Words selection					
Plane Size	1 H x 1 V 1 Pages; 2 H x 1 V 1 Pages; 2 H x 2 V Pages					
Plane Count	4	4	4	4	16	16
Bitmap Display	Display Allowed	Display Allowed	Display Not Allowed	Display Not Allowed	Display Allowed	Display Not Allowed
Bitmap Size	512 H x 256 V Dots 512 H x 512 V Dots 1024 H x 256 V Dots 1024 H x 512 V Dots selection		None		512 H X 256 V Dots 512 H X 512 V selection	None
Scale Function	1/4~256 ratio		None		Any Ratio	
Rotation Function	None				Yes	
Line Scroll Function	Yes	Yes	No	No	No	
Vertical Cell Scroll Function	Yes	Yes	No	No	No	
Mosaic Process Function	Yes				Yes (Horizontal Direction Only)	

**Note:** \*There are 2048 colors when the color RAM is in mode 1, and 1024 colors when in mode 0 or 2.

Normal scroll screen changes the number of screens that can be displayed through each setting.





The normal scroll screen can be displayed simultaneously with one rotation scroll screen. If two rotation scroll screens are displayed, the normal scroll screen cannot be displayed (the register that sets RGB1 is used for NBG0). When an external input screen is displayed, NBG1 cannot be displayed. The register setting the external input screen can be used for NBG1.

### **Line Screen**

The line color screen works for color calculation and on other screens. It can indicate whether the entire screen consists of one color, or if there is a color for each line, but it cannot display characters.

The back screen is displayed when all other screens are transparent. The entire screen is displayed in one color, or a color can be selected for each line, but characters cannot be displayed.

### **Windows**

A rectangular window can be selected by using the two screen coordinate value points in the upper left and lower right corners of a normal window. The sprite window is a window based on sprite characters. There are three types of windows that can be used and stacked individually for each screen: the "transparent control window" designates the transparent area; the "color calculation window" designates the area in which color calculation is not performed; the "rotation parameter window" changes screens by two rotation parameters.

## 1.4 Priority Function

There are four types of VDP2 priority functions: priority function, color calculation function, color offset function, and shadow function.

### Priority Function

The display priority of the sprite and scroll screen is decided by a 3-bit priority number. The sprite priority number can be set at a maximum value of 8, one of which is designated by character units. The scroll screen priority number is usually designated by surface units. When the special priority function is used, character units and dot units can change the scroll screen priority number.

### Color Calculation Function

By adding color data of multiple screens, the color calculation function produces an effect in which the back screen can be seen through the front screen. It is normally performed by two screen images, the top image and the second image, but up to four screens can be performed when the expanded color calculation function is used. Surface units determine whether the color calculation is performed. Sprites can be selected by character units through sprite color calculation condition settings. When a scroll screen uses the special color calculation function, sprites can be selected by character units and dot units.

The color calculation ratio of the top and second images can be selected from 32 steps. Sprites can set a maximum of 8 color calculation ratios, among which one can be selected by character units. The scroll screen is selected by surface units.

When the Gradation function is used, one selected screen can be gradated horizontally and displayed.

### Color Offset Function

The color offset function is used for displaying the offset value calculation (subtraction) for color data, and for fade in and fade out purposes. The color offset function can be specified by surface unit. Up to two color offset values can be selected for each RGB, one of which can be specified by surface units.



## **Shadow Function**

The shadow function adds shadow to the shapes of sprite characters on each screen. There are two types of sprite shadow: normal shadow by data, and MSB shadow. The normal shadow can only add a shadow to the scroll screen. The MSB shadow can add a shadow to scroll screens and to sprites.

SEGA Confidential

(This page was blank in the original Japanese document.)

SEGA Confidential



## Chapter 2 TV Screen

2.1	TV Screen Mode .....	12
	Special High Resolution Graphics Mode .....	13
2.2	Interlace Mode .....	14
2.3	TV Screen Structure .....	15
2.4	TV Screen Mode Register .....	16
2.5	External Signals and Scan Conditions .....	19
	External Signal Enable Register .....	19
	Screen Status Register .....	21
	H Counter Register .....	23
	V Counter Register .....	24

## 2.1 TV Screen Mode

VDP2 can display images in 31 kHz monitors as well as high-vision monitors, and in NTSC and PAL standards for TV. There are three kinds of image displaying TV screen modes: normal, high-resolution, and special monitor. Screen scan format can be selected from three types: non-interlace, single-density interlace, and double-density interlace. A register showing TV scan conditions is also provided.

Table 2.1 shows the TV screen modes that are selectable, the graphics mode, and the current resolution. Furthermore, special settings are required when indicating special high-resolution graphics A and special high-resolution graphics B.

**Table 2.1 TV Screen Mode**

TV Screen Mode	Graphics Mode	Interface Mode	Horiz X Vertical. Resolution (Pixels)	Restrictions During Use
Normal	Normal Graphic A	Non-interlace	320 X 224	
			320 X 240	
			320 X 256	PAL standard only
		Interlace	320 X 448	
			320 X 480	
	Normal Graphic B	Non-interlace	320 X 512	PAL standard only
			352 X 224	
			352 X 240	
		Interlace	352 X 256	PAL standard only
			352 X 448	
Hi-Res	Hi-Res Graphic A	Non-interlace	352 X 480	
			352 X 512	PAL standard only
			640 X 224	
		Interlace	640 X 240	
			640 X 256	PAL standard only
	Hi-Res Graphic B	Non-interlace	640 X 448	
			640 X 480	
			640 X 512	PAL standard only
		Interlace	704 X 224	
			704 X 240	
		Non-interlace	704 X 256	PAL standard only
			704 X 448	
		Interlace	704 X 480	
			704 X 512	PAL standard only
		Non-interlace	320 X 480	31kHz monitor only
		Non-interlace	352 X 480	Hi-vision monitor only
		Non-interlace	640 X 480	31kHz monitor only
		Non-interlace	704 X 480	Hi-vision monitor only

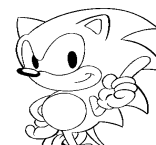

## Special High-Resolution Graphics Mode

The graphics mode of special high-resolution graphics A or B displays one screen by joining the NBG0 and NBG1 screens. If the following setting is not performed, the display will not appear correctly.

- Must be able to display only NBG0 and NBG1.
- The NBG0 and NBG1 character pattern tables (or, bit map pattern) and pattern name tables must use the exact same data.
- Must be able to reduce both NBG0 and NBG1 horizontally up to 50%.
- Set the vertical direction screen scroll values of NBG0 and NBG1 so that they are identical.
- Set the NBG1 horizontal screen scroll value at the NBG0 horizontal screen scroll value plus 1.
- Set both NBG0 and NBG1 horizontal coordinate increments at 2.
- Set the color RAM mode to 0.
- Set the priority numbers of NBG0 and NBG1 at the same value.
- Do not enter the line color screen.
- Special priority of both NBG0 and NBG1 should be in mode 0.
- Do not use the color calculation function.
- For registers other than those listed above, NBG0 and NBG1 settings should be the same.

## 2.2 Interlace Mode

VDP2 interlace mode (screen scan method) consists of non-interlace, single-density interlace, and double-density interlace modes. The non-interlace mode is 1 field per frame (1/60 sec.). The single-density interlace mode is 2 fields (1/30 sec.) per frame; the same image is displayed in even and odd fields. The double-density interlace mode is 2 fields (1/30 sec.) per 1 frame with separate images being displayed in even and odd fields. There is no space between scan lines in both the single-density and double-density interlace modes, but the actual resolution in the vertical direction of the single-density interlace mode is the same as the resolution in the vertical direction of the non-interlace mode. Figure 2.1 shows display methods by interlace settings.

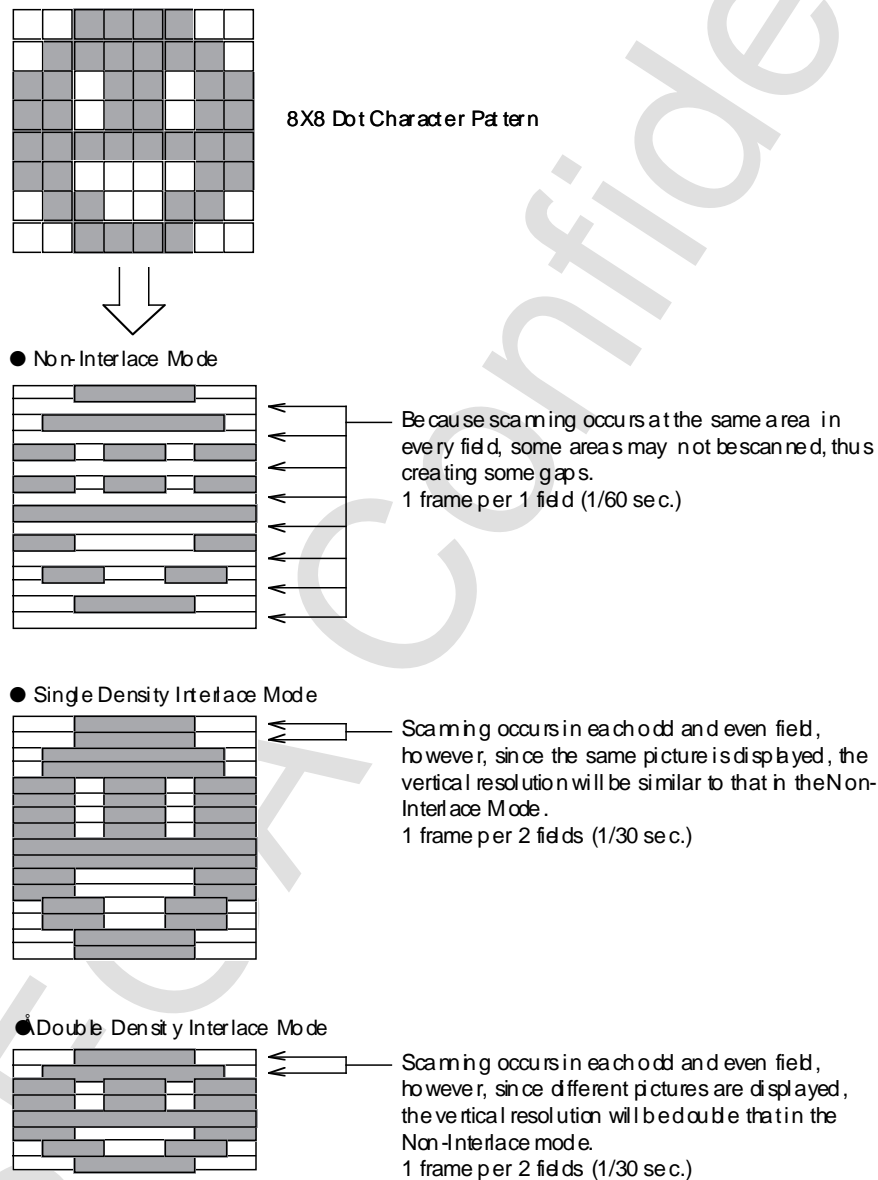

**Figure 2.1 Display Method by Interlace Setting**





## 2.3 TV Screen Structure

In response to the TV screen mode, VDP2 outputs image signals corresponding to their respective NTSC standard or PAL standard TV, 31 kHz monitor, and high-vision monitor. The TV screen is a collection of rasters constructed by vertical display intervals, vertical blank intervals (V blank interval), and their respective horizontal display intervals and horizontal blank intervals (H blank interval). The TV screen structure is shown in Figure 2.2. The location where horizontal display intervals and vertical display intervals overlap is the standard display area of the various TV formats. The set display area, where VDP2 is able to display the image, is slightly smaller than the standard display area. The border area excludes the set display area from the standard display, and can output either black or the back screen.

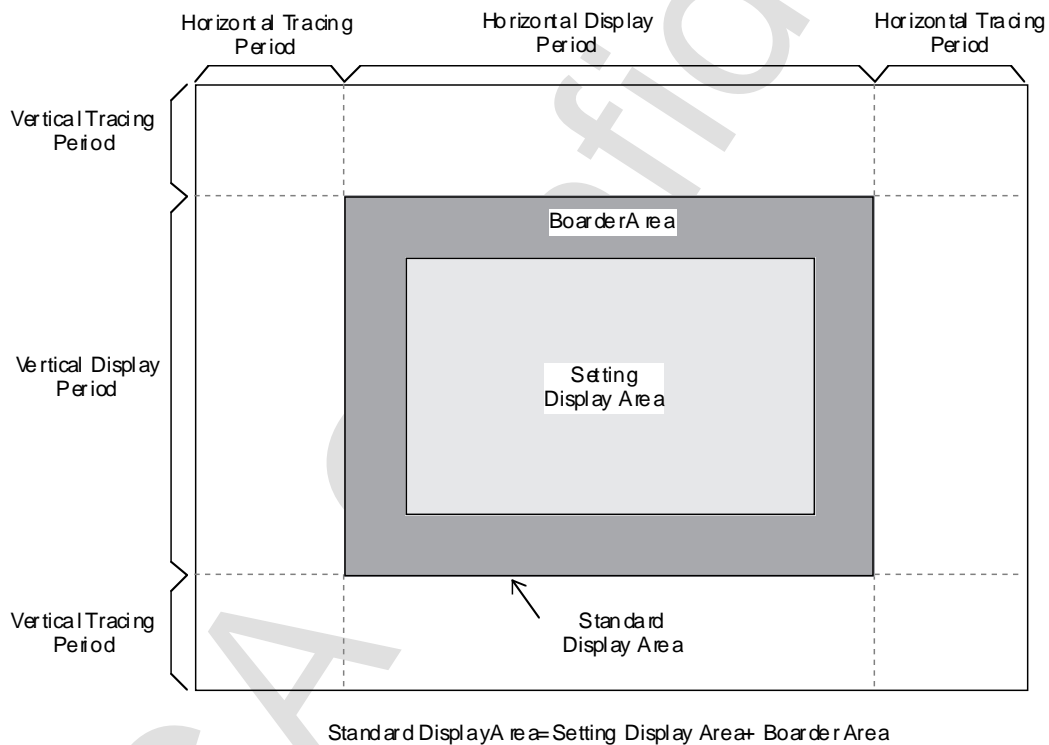

Figure 2.2 TV Screen Structure

## 2.4 TV Screen Mode Register

The TV screen mode register controls the TV screen display. It is a read/write 16 bit register and is at address 180000H. After the power on or reset, the value is cleared to 0 and therefore must be set.

	15	14	13	12	11	10	9	8
TVMD	DISP	~	~	~	~	~	~	BDCLMD
180000H	7	6	5	4	3	2	1	0
	LSMD1	LSMD0	VRESO1	VRESO0	~	HRESO2	HRESO1	HRESO0

- **TV screen display bit : Display bit (DISP), bit 15**

Controls picture display to the TV screen.

DISP	Process
0	Picture is not displayed on TV screen
1	Picture is displayed on TV screen

Because it is in the blank condition during the display interval when this bit is 0, the VRAM can be accessed from the CPU or DMA controller at any time. The colors displayed when this bit is 0 are selected by the BDCLMD bit. Please make sure to change this bit from 0 to 1 during V blank.

- **Border color mode bit (BDCLMD), bit 8**

Controls colors displayed by the border area.

BDCLMD	Process
0	Displays black
1	Display back screen

Selects colors of all the standard display areas when the DISP bit is 0. However, after the power on or reset, if this bit is set to 1 without setting DISP bit to 1 even once, the back screen will not be correctly displayed. When the setting allows the back screen selection by line, the color displayed in the border area will become the same color as the lowermost line in the display area.



• **Interlace mode bit (LSMD1, LSMD0) bits 7 and 6**

Designates the interlace mode.

LSMD1	LSMD0	Process
0	0	Non-Interlace
0	1	Setting not allowed
1	0	Single-density interlace
1	1	Double-density interlace

Single-density interlace is a mode that shows the same pictures in odd and even fields; double-density interlace is a mode that shows different pictures in odd and even fields. In either case, the spaces between scan lines are not vacant. The vertical resolution for double-density interlace is twice that of non-interlace, but the vertical resolution of the actual picture for single-density interlace is the same for non-interlace. Pictures displayed in double-density interlace are vertically half the size of pictures displayed in single-density interlace or non-interlace. When the horizontal resolution (HRESO2 to HRESO0) setting is in the exclusive monitor mode, make sure to select the noninterlaced mode (00B).

• **Vertical resolution bit (VRESO1, VRESO0), bit 5, 4**

Designates vertical resolution when a picture is displayed on the TV screen.

VRESO1	VRESO0	Vertical Resolution	Display Monitor
0	0	224 Lines	NTSC or PAL format TV
0	1	240 Lines	NTSC or PAL format TV
1	0	256 Lines	PAL format TV
1	1	Not Allowed	-

Increments when vertical resolution is increased, then are added to the top and bottom of the screen without changing the screen's center. When set in the special monitor mode, the horizontal resolution (HRESO2 to HRESO0) is set to 480 lines. Settings of this bit are ignored.

• **Horizontal resolution bit (HRESO2 to HRESO0), bit 2 to 0**

Selects the horizontal resolution when a picture is displayed on the TV screen.

HRESO2	HRESO1	HRESO0	Horizontal Resolution	Graphic Mode	Display Monitor
0	0	0	320 Pixels	Normal Graphic A	NTSC Format or PAL Format TV
0	0	1	352 Pixels	Normal Graphic B	
0	1	0	640 Pixels	Hi-Res Graphic A	
0	1	1	704 Pixels	Hi-Res Graphic B	
1	0	0	320 Pixels	Exclusive Normal Graphic A	31kHz Monitor
1	0	1	352 Pixels	Exclusive Normal Graphic B	Hi-Vision Monitor
1	1	0	640 Pixels	Exclusive Normal Graphic A	31kHz Monitor
1	1	1	704 Pixels	Exclusive Normal Graphic B	Hi-Vision Monitor

When special high-resolution graphics A or B is selected, other registers must be set as directed. See “Special High Resolution Graphics Mode” on page 13 for more information. When switching the TV mode from exclusive monitor mode to normal mode or hi-res mode, make sure to reset the VDP2.



## 2.5 External Signals and Scan Conditions

The register controlling external signals has an external signal enable register. The register displaying TV scan conditions has a screen status register, H counter register, and V counter register.

### External Signal Enable Register

The external signal enable register controls signals from the VDP2 exterior. It is a read/write 16 bit register and is at address 180002H. After the power is turned on or reset, the value is cleared to 0 and must be set.

	15	14	13	12	11	10	9	8
EXTEN	~	~	~	~	~	~	EXLTEN	EXSYEN
180002H	7	6	5	4	3	2	1	0
	~	~	~	~	~	~	DASEL	EXBGEN

- **External latch enable bit (EXLTEN), bit 9**

Selects the condition for latching the HV counter value to the HV counter register.

EXLTEN	Condition
0	Latches when reading external signal enable register
1	Latches through external signal

The latched H counter value can read with the H counter register; V counter value can read with the V counter register. When reading H and V counter values through external signals such as laser guns, the bit should be set at 1. Otherwise, it should be set at 0.

- **EXSYNC enable bit (EXSYEN), bit 8**

Controls input to the internal synchronous circuit of the external sync signal.

EXSYEN	Process
0	Does not input external sync signal
1	Inputs external sync signal, and synchronizes TV screen display with the external

When synchronizing with other devices and screen displays, set to 1 and input an EXSYNC signal. The normal setting is 0.

- **Display area select bit (DASEL), bit1**

Designates the image display area. Valid only when the EXBGEN bit is 1.

DASEL	Process
0	Displays screen image only in the set display area
1	Displays screen in the standard display area

When displaying the entire standard display area, images from external screen data are displayed correctly. Images not in set display areas (sprite, scroll screen, etc.) need to be made transparent using a window because they are not displayed correctly.

• **EXBG enable bit (EXBGEN), bit 0**

Controls input of external screen data.

EXBGEN	Process
0	Does not input external screen data
1	Inputs external screen data

Because the data becomes NBG1 screen data when inputting external screen data, the external screen settings are used for NBG1 as well. Table 2.2 shows the register bit for setting the external screen.



**Table 2.2 Register for setting the external screen**

Address	Bit Number	Bit Name	
180020H	9	N1TPON	Transparent display enable
180028H	13,12	N1CHCN1, N1CHCN0	Character Color Count
1800D0H	8	N1W0A	W0 window area
	9	N1W0E	W0 window enable
	10	N1W1A	W1 window area
	11	N1W1E	W1 window enable
	12	N1SWA	SW window area
	13	N1SWE	SW window enable
	15	N1LOG	Window logic
1800E2H	1	N1SDEN	Shadow enable
1800E4H	6~4	N1CAOS2~N1CAOS0	Color RAM address offset
1800E8H	1	N1LCEN	Line color screen insertion enable
1800EAH	3,2	N1SPRM1, N1SPRM0	Special priority mode
1800ECH	1	N1CCEN	Color calculation enable
1800EEH	3,2	N1SCCM, N1SCCM0	Special color calculation mode
1800F8H	10~8	N1PRIN2~N1PRIN0	Priority number
180118H	12~8	N1CCRT4~N1CCRT0	Color Calculation Ratio
180110H	1	N1COEN	Color offset enable
180112H	1	N1COSL	Color offset select

### Screen Status Register

The screen status register displays TV screen information. This read exclusive 16-bit register is at address 180004H.

	15	14	13	12	11	10	9	8
TVSTAT	~	~	~	~	~	~	EXLTFG	EXSYFG
180004H	7	6	5	4	3	2	1	0
	~	~	~	~	VBLANK	HBLANK	ODD	PAL

- **External latch flag (EXLTFG), bit 9**

Through external signals, this displays whether the HV counter value is latched to the HV counter register. Clears to 0 when the screen status register reads out.

EXLTFG	HV Counter Value Status
0	Not latched in register
1	Latched in register

- **External SYNC flag (EXSYFG), bit 8**

Displays whether the internal routes through External SYNC flag are in sync. Clears to 0 when the screen status register reads out.

EXSYFG	External Sync Status
0	Not synchronized
1	Internal circuit synchronized

- **Vertical blank flag (VBLANK), bit 3**

Displays the vertical scan status of the TV screen.

VBLANK	Vertical Scan Status
0	During vertical scan
1	During vertical re-trace (VBLANK)

- **Horizontal blank flag (HBLANK), bit 2**

Displays the horizontal scan status of the TV screen.

HBLANK	Horizontal Scan Status
0	During horizontal scan
1	During horizontal re-trace (HBLANK)





• **Scan Field Flag : Odd/even field flag (ODD), bit 1**

Scan conditions are shown when the TV screen mode is the interlace mode. The non-interlace mode is always 1.

ODD	Display
0	During even field scan
1	During odd field scan

• **TV standard flags : PAL/NTSC flag (PAL), bit 0**

Displays TV standards.

PAL	Display
0	NTSC standard
1	PAL standard

**H Counter Register**

The H counter register shows the H counter value. This read exclusive 16-bit register is at address 180008H.

	15	14	13	12	11	10	9	8
HCNT	~	~	~	~	~	~	HCT9	HCT8
180008H	7	6	5	4	3	2	1	0
	HCT7	HCT6	HCT5	HCT4	HCT3	HCT2	HCT1	HCT0

• **H counter bit (HCT9 to HCT0), bits 9 to 0**

Signals controlled through EXLTEN external signal enable register show the latched H counter values. The bit configuration of this bit changes according to the setting of the graphics mode, as seen in Table 2.3. For normal graphics of H counter values, the HCT0 of the least significant bit is invalid data. For special normal graphics of H counter values, the HCT9 of the most significant bit is invalid data. For the H counter value of special high-resolution graphics, the most significant bit of HCT9 becomes invalid. Because there is no bit for H0, it shows a value of 2 dot units.

**Table 2.3 H counter register bit content**

Graphic Mode	HCT9	HCT8	HCT7	HCT6	HCT5	HCT4	HCT3	HCT2	HCT1	HCT0
Normal	H8	H7	H6	H5	H4	H3	H2	H1	H0	Invalid
Hi-Res	H9	H8	H7	H6	H5	H4	H3	H2	H1	H0
Exclusive Normal	Invalid	H8	H7	H6	H5	H4	H3	H2	H1	H0
Exclusive Hi-Res	Invalid	H9	H8	H7	H6	H5	H4	H3	H2	H1

## V Counter Register

The V counter register shows the V counter value. This read exclusive 16-bit register is at address 18000AH.

	15	14	13	12	11	10	9	8
VCNT	~	~	~	~	~	~	VCT9	VCT8
18000AH	7	6	5	4	3	2	1	0
	VCT7	VCT6	VCT5	VCT4	VCT3	VCT2	VCT1	VCT0

### • V counter value bit : V counter bit (VCT9~VCT0), bit 9 to 0

Signals controlled through EXLTEN external signal enable register show the latched V counter values. The bit configuration of this register changes according to the settings of the TV screen mode, as shown in Table 2.4. The V counter values for single density interlace of the normal and high resolution modes show V counter values in their various even and odd fields. The V counter values for double density interlace of normal and high resolution modes show the odd fields when 0 and even field when the least significant bit of VCT0 is 1. VCT1~VCT9 show the V counter values in their respective fields.

**Table 2.4 V counter register bit content**

TV Screen (Interlace) Mode	VCT9	VCT8	VCT7	VCT6	VCT5	VCT4	VCT3	VCT2	VCT1	VCT0
Normal Hi-Res (Non-Interlace, Single-Density Interlace)	V8	V7	V6	V5	V4	V3	V2	V1	V0	Invalid
Normal Hi-Res (Double-Density Interlace)	V8	V7	V6	V5	V4	V3	V2	V1	V0	0: Odd fields 1: Even fields
Exclusive Monitor	V9	V8	V7	V6	V5	V4	V3	V2	V1	V0



## Chapter 3 RAM

Introduction .....	26
3.1 Address Map .....	26
VRAM Size Register .....	28
3.2 VRAM Bank Partitioning .....	29
RAM Control Register .....	29
3.3 Accessing VRAM During Display Interval .....	31
VRAM Access During Display Interval .....	31
Image Data Access .....	32
Vertical Cell Scroll Table Data Access .....	35
Read/Write Access by the CPU .....	35
VRAM Cycle Pattern Selection Process .....	37
VRAM Cycle Pattern Register .....	39
3.4 Color RAM Mode .....	43
RAM Control Register .....	45

## Introduction

VDP2 is connected to special VRAM for defining pattern name tables, character patterns, and so on. VRAM has two divisions called VRAM-A and VRAM-B, each having equal capacity. VRAM-A and VRAM-B can each be divided into two banks, called bank 0 and bank 1. Banks divided with four equal capacities are called VRAM-A0, VRAM-A1, VRAM-B0, and VRAM-B1. VRAM data is defined in table 3.1. Also contained is color RAM for defining the color data of scroll screens and sprites.

**Table 3.1 Data defined in VRAM**

Data that must be defined when display format is cell (format)	Data that must be defined when display format is bitmap (format)	Data defined as necessary
Pattern name table data Character pattern data	Bitmap pattern data	Line scroll table data Vertical cell scroll table data Rotation parameter table data Coefficient table data Line color screen table data Back screen table data Line window table data

### 3.1 Address Map

VDP2 can be applied to two types of VRAM: 4 Mbit and 8 Mbit. Programs created for systems using a 4 Mbit VRAM can also be used in systems using 8 Mbit VRAM, but programs created for systems using an 8 Mbit VRAM cannot be used in systems using 4 Mbit VRAM.



The address map changes according to VRAM capacity being used in the system, as shown in Figure 3.1.

● VRAM Size: 4M Bit

000000H	VRAM-A0
01FFFFH 020000H	
03FFFFH 040000H	VRAM-B0
05FFFFH 060000H	VRAM-B1
07FFFFH	

● VRAM Size: 8M Bit

000000H	VRAM-A0
03FFFFH 040000H	
07FFFFH 080000H	VRAM-B0
0BFFFFH 0C0000H	VRAM-B1
0FFFFFFH	

**Figure 3.1 Different Capacities of VRAM Address Map**

## VRAM Size Register

The VRAM size register indicates the VRAM capacity to be used in the system. It is a read/write 16-bit register and is at the 180006H address. Bits 3 to 0 are exclusively for read only. Because the value of bit15 (VRAMSZ) is cleared to 0 after the power is turned on or reset, it must be reset.

	15	14	13	12	11	10	9	8
VRSIZE	VRAMSZ	~	~	~	~	~	~	~
180006H	7	6	5	4	3	2	1	0
	~	~	~	~	VER3	VER2	VER1	VER0

### VRAM size bit (VRAMSZ), bit 15.

Indicates the VRAM capacity used in the system.

VRAMSZ	VRAM Size
0	4 Mbit
1	8 Mbit

This bit must be set before data is written to VRAM.

### Version Number Bit (VER3 to VER0), Bits 3 to 0

Shows the VDP2 version number; the first is 0.



## 3.2 VRAM Bank Partitioning

VDP2 can access VRAM-A0, VRAM-A1, VRAM-B0, and VRAM-B1 at the same time when both VRAM-A and VRAM-B are divided in half. As a result, more image data can be obtained at once, a higher number of scroll screens can be displayed simultaneously, and a screen with multiple colors can be displayed. However, there are limitations when selecting of VRAM read/write access through the CPU during the display. Therefore, don't partition the VRAM into two areas when accessing (read/write) through the CPU during the display. Normally, accessing can be efficiently done if divided into two areas.

### RAM Control Register

RAM control register selects VRAM bank partitions with the objective of using the rotation scroll screen VRAM as well as the color RAM mode. It is a read/write 16-bit register and is at the 18000EH address. Also, because the value is cleared to 0, it must be set after the power is turned on or reset.

	15	14	13	12	11	10	9	8
RAMCTL	CRKTE	~	CRMD1	CRMD0	~	~	VRBMD	VRAMD
18000EH	7	6	5	4	3	2	1	0
	RDBSB11	RDBSB10	RDBSB01	RDBSB00	RDBSA11	RDBSA10	RDBSA01	RDBSA00

#### Color RAM Coefficient Table Enable Bit (CRKTE), Bit 15

See "6.4 Coefficient Table Control."

#### Color RAM Mode Bit (CRMD1, CRMD0), Bits 13 and 12

See "3.4 Color RAM Mode." Set the Color RAM mode to mode 1 when the CRKTE bit is 1. At that time, color data can no longer be stored because the second half of the color RAM (100800H ~ 100FFFH) is used for the coefficient table data.

#### VRAM Mode Bit (VRBMD, VRAMD), Bits 9 and 8

Controls VRAM bank partitions.

VRAMD	18000EH	Bit 8	For VRAM-A
VRBMD	18000EH	Bit 9	For VRAM-B

VRxMD	Process
0	Do not partition in 2 banks
1	Partition in 2 banks

**Note:** Enter A or B into bit name for x.

**Rotation Data Bank Select bit: RBG0 DataBank Select Bit (RDBSA00 to RDBSB11), Bits 7 to 0**

See "6.2 Rotation Scroll Screen Display Control".

When the CRKTE bit is 1, do not designate to allow the 4 banks of VRAM to be used as RAM for the coefficient table data.

SEGA

Confidential





### 3.3 Accessing VRAM During Display Interval

#### VRAM Access During Display Interval

VDP2 synchronizes scroll screen data with the TV scan and displays them while reading from VRAM. VRAM access during display repeats the cycle as four or eight access operating units (1 cycle). When the TV screen mode is the Normal mode, 1 cycle accesses eight times. Also, 1 cycle is accessed four times when in the high-resolution or special monitor mode. Below are the ten types of VRAM accesses performed in one cycle:

- (1) Normal scroll screen pattern name data read access.
- (2) Normal scroll screen character pattern data read access or bit map pattern data read access.
- (3) NBG0, NBG1 vertical cell scroll table data read access.
- (4) Read / Write access through the CPU.
- (5) Does not access.
- (6) RGB0 pattern name data read access.
- (7) RGB0 character pattern data read access or bit map pattern data read access.
- (8) RGB0 coefficient table data read access.
- (9) RGB1 pattern name data read access.
- (10) RGB1 character pattern data read access.

The timing during the 1 cycle when the above (1) through (5) are performed must be selected for each bank of VRAM-A0, VRAM-A1, VRAM-B0, and VRAM-B1. This selection is performed by writing the values of 4 bits, called access commands, to the VRAM cycle pattern register. Access Commands correspond to the several types of VRAM access.

Each VRAM access in the above items (6) through (8) occupies a full one cycle, therefore, for one bank only one type may be selected. This is accomplished by writing the value corresponding to each VRAM access type to the RAM control register rotation data bank select bit. The setting of the bank VRAM cycle pattern register, which select (6) through (8) VRAM access, will become invalid.

Each VRAM access in the above items (9) and (10) occupies a full one cycle. (9) is fixed in VRAM-B1 and (10) in VRAM-B0. While items (9) and (10) are selected automatically with the display of RGB1, the setting of the VRAM-B0 and VRAM-B1 VRAM cycle pattern registers will become invalid.

The VRAM cycle pattern register has registers that correspond to the following banks: VRAM-A0, VRAM-A1, VRAM-B0, VRAM-B1. When the VRAM is not divided into two partitions, the VRAM-A0 register is used for VRAM-A, and the VRAM-B0 register is used for VRAM-B. Registers for VRAM-A1 and VRAM-B1 are not used. Registers that correspond to the various banks are separated into eight (T0 to T7) access timings. Access is performed in order, beginning from VRAM access, showing the access command selected in the T0 bit. T0 to T7 are in effect when the TV screen is in Normal mode, but only T0 to T3 are in effect for the high-resolution or special monitor mode; T4 to T7 are ignored. Figure 3.2 shows the VRAM cycle pattern register used during 1 cycle.

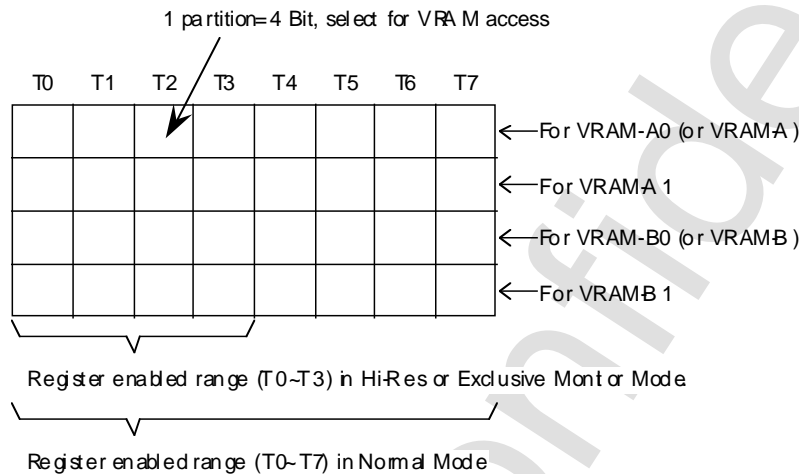

Figure 3.2 VRAM Cycle Pattern Register

Be sure to set “do not access” for the remaining access time after selecting the VRAM access required in the display. If the VRAM access address selected in the VRAM cycle pattern register is not the address in the selected bank, access won’t be done and the correct screen will not be displayed.

### Image Data Access

The required image data must be read from VRAM for normal scroll screens (NBG0 to NBG3) to be displayed. When the display format is the cell format, the required image data is pattern name data and character pattern data. When in a bit map format, the necessary image data is bit map pattern data. The VRAM access number for obtaining this image data during 1 cycle is decided by the conditions.



Pattern name data read access during 1 cycle must be set to a maximum of two banks, one being either VRAM-A0 or VRAM-B0, and the other being VRAM-A1 or VRAM-B1. When the VRAM is not divided into two partitions, the VRAM-A0 register is used as VRAM-A, and the VRAM-B0 register is used as VRAM-B; therefore, one or the other must be set. Any access timing may be selected if within the register's effective range in all TV screen modes. The access number must be the same as the number as determined by conditions, but the related timing does not need to be selected.

The pattern name data read access number is shown in Table 3.2. The pattern name data read access selection limits are shown in Figure 3.3.

**Table 3.2 Access numbers of required pattern name table data during 1 cycle**

Item	NBG0~NBG3		
Reduction setting	x1	x1/2	x1/4
Number of VRAM accesses required during 1 cycle	1	2	4

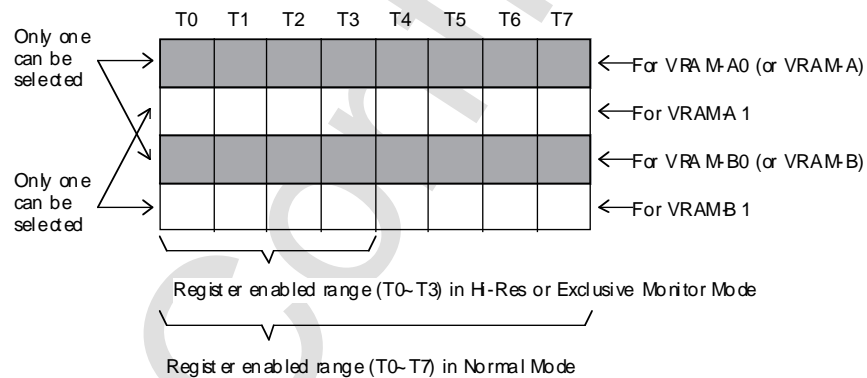

**Figure 3.3 Access selection limits of pattern name table data**

As a rule, the character pattern data read access during 1 cycle can select any timing from four banks. However, the timing that can be selected through pattern name data access timing is limited. Only when the pattern name data access of NBG0 and NBG1 are selected in T0 can select various character pattern data read accesses through the timings of any of the four banks be selected with are no limits. The access number must be selected so that it is the same as the number as determined by the conditions. The related timing does not need to be selected. Character pattern data read access numbers are shown in Table 3.3. Character pattern data read access selection limits are shown in Table 3.4.

**Table 3.3 Character pattern data (bit map pattern data) read access number**

Item	NBG0~NBG3								
Character Color Count	16		256		2048		32,768		16,770,000
Reduction setting	1	1/2	1/4	1	1/2	1	1	1	
Number of VRAM accesses required during 1 cycle	1	2	4	2	4	4	4	8	

**Table 3.4 Character pattern data read access selection limits**

Item	TV Screen Mode	Pattern Name Table Data Access Timing							
		T0	T1	T2	T3	T4	T5	T6	T7
Timing that can select character pattern data access	Normal	T0~T2, T4~T7	T0~T3, T5~T7	T0~T3, T6~T7	T0~T3, T7	T0~T3	T1~T3	T2, T3	T3
	Hi-Res, exclusive monitor	T0~T2	T1~T3	T0, T2, T3	T0, T1, T3	-	-	-	-

When the reduction setting is one, all of the character pattern data read access must observe selection limits if the character pattern data read access is to be two or greater. If the reduction setting is 1/2 or 1/4, the required access number when the reduction setting is 1 (one time for 16 colors and two times for 256 colors) must observe selection limits through one time pattern name data read access. Figure 3.4 shows character pattern data read access selection limits when the pattern name data read access is selected in T1 and T3, with 256 colors and 1/2 reduction.

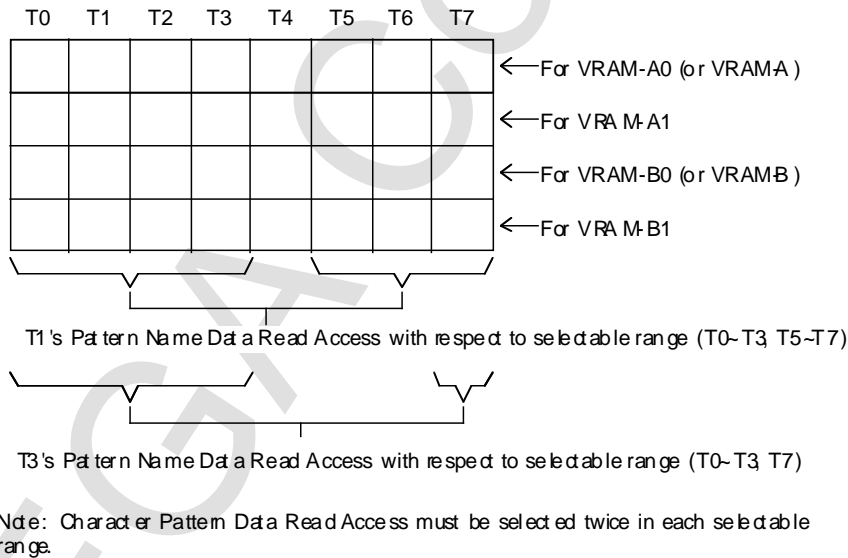

**Figure 3.4 Example of character pattern data read access selection**



## Vertical Cell Scroll Table Data Access

When using the vertical cell scroll function in NBG0 and NBG1 {Translator's Note: The original document reads NB1, we believe this is an error.}, vertical cell scroll table data must also be read.

Vertical cell scroll table data read access must be performed for one surface during 1 cycle. Vertical cell scroll table data read access for NBG0 must be selected in T0 or T1 timing. NBG1 vertical cell scroll table data read access must be selected within the timing of T0 to T2. Also, access for NBG0 and NBG1 must be by the same bank and NBG0 access must be selected first.

When specifying the same vertical cell scroll table data read access against multiple banks, make sure to specify the same access timing.

Figure 3.5 shows access selection limits of vertical cell scroll table data.

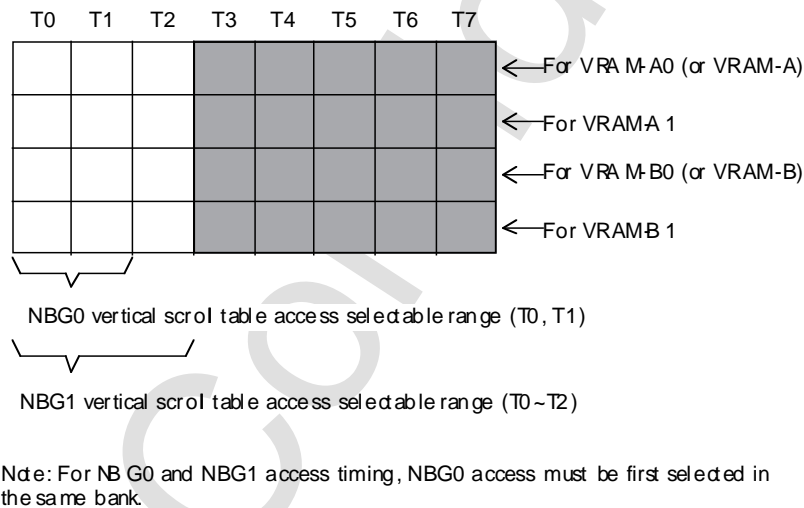

**Figure 3.5 Access select limits of vertical cell scroll table data**

## Read/Write Access by the CPU

When performing read/write access to the VRAM by the CPU during the screen display interval, the timing must be set to the VRAM cycle pattern register. VDP2 waits for the selected timing in the CPU read/write access when VRAM access is requested by the CPU, and approves access only in that timing. When read/write access is not requested by the CPU, nothing will be performed for VRAM, even for selected timings. Moreover, during read access through the CPU, the wait cycle will enter the CPU until it is able to read. The write access wait cycle will not be entered if the two word write access is at least two times.

VRAM access by the CPU can be selected only in units of access to VRAM-A or VRAM-B, and can not be selected in bank units.

When selecting VRAM access by the CPU for the VRAM without two partitions, you should select the CPU read/write access command in the VRAM cycle pattern register of the timing performing the access. Selecting an access command that does not access in place of the CPU read/write access command is the same as before. In the screen display enable register, when the access command (pattern name data read, character pattern data read, or bit map pattern data read) used for a screen not set to be displayed is also set, it becomes the CPU read/write access. See “4.1 Screen Display Control” about the screen display enable register.

When selecting an access command for not to access or CPU read/write with respect to every access timing of the VRAM that is not partitioned into two areas, the CPU access will then be always allowed during display period. This allows to use one of the VRAMs as an auxiliary work RAM. In addition, by switching the VRAM used in the image display as a frame buffer, the image can be displayed while being rewritten at a high speed.

Figure 3.6 illustrates the VRAM cycle pattern register selection if CPU read/write access is being performed in T2 and T4 when VRAM-A is not partitioned.

T2	T3	T4	T5	
CPU Read/Write	Other Access Commands	No Access	Other Access Commands	VRAM Cycle Pattern Register for VRAM-A

**Figure 3.6 CPU Read/Write Access Selection when VRAM is not Divided into Two Bank**

When setting the CPU read/write access for the VRAM that is partitioned into two areas, the CPU read/write access command must be set in the VRAM cycle pattern register of both bank 0 and bank 1 of the timing performing access. Further, in the registers of both bank 0 and bank 1 of the timing before the set CPU read/write access command timing, the access command that won't access must be selected. However, when selecting CPU read/write access in linked timing, only the timing before the lead of the linked access timing may be selected.

Figure 3.7 illustrates the selection of the VRAM cycle pattern register when performing CPU read/write access linked to T4 and T5 while VRAM-B is divided into two partitions.



	T3	T4	T5	T6	
	No Access	CPU Read/Write	CPU Read/Write	Other Access Commands	VRAM Cycle pattern Register for VRAM-B0
	No Access	CPU Read/Write	CPU Read/Write	Other Access Commands	VRAM Cycle pattern Register for VRAM-B1

**Figure 3.7 CPU Read/Write Access Selection when VRAM is Divided into Two Banks**

### VRAM Cycle Pattern Selection Process

Selection process to the VRAM cycle pattern register is listed below.

1. Decide the TV screen mode.
2. Decide whether to partition the VRAM into two segments.
3. Decide the number of character colors of the scroll screen being displayed and the reduction setting. Also, decide whether to use the vertical cell scroll function.
4. Decide the VRAM bank that will store the required image data (patternname data, character pattern data, bit map pattern data) for all scroll screens. Decide the VRAM bank for storing vertical cell scroll table data when the vertical cell scroll function is used.
5. Decide whether to read/write access through the CPU.
6. To observe selection limits of various access timings, select access command in the VRAM cycle pattern register.

An example of VRAM cycle pattern register selection is shown in Figure 3.8.

<Condition>

Set TV screen in normal mode.  
Partition both VRAM-A and VRAM-B into two areas.  
Set the scroll screen as follows:

Screen Name	Character Colors	Reduction Setting	Vertical Cell Scroll Function
NBG0	256 Colors	x1/2	Do not use
NBG1	256 Colors	x1	Use
NBG3	256 Colors	x1	-

Banks that store data per each scroll screen:

Screen Name	Pattern Name	Character Pattern	Vertical Cell Scroll Table
NBG0	A0	B0,B1	-
NBG1	A0,A1	B0,B1	A0
NBG3	A1	A1,B0	-

A0: VRAM-A0 A1: VRAM-A1 B0: VRAM-B0 B1: VRAM-B1

Allow CPU read/write access to VRAM-A

<VRAM CYCLE PATTERN REGISTER>

T0	T1	T2	T3	T4	T5	T6	T7	
N1CE	N0PN	N1PN	N0PN	NA	CPU	CPU	NA	For VRAM-A0 (or VRAM-A)
N3PN	NA	N1PN	NA	NA	CPU	CPU	N3CG	For VRAM-A1
N0CG	N0CG	N1CG	N1CG	NA	N0CG	N0CG	N3CG	For VRAM-B0 (or VRAM-B)
N0CG	N0CG	N1CG	N1CG	NA	N0CG	N0CG	NA	For VRAM-B1

N0PN : Pattern name data read for NBG0, N0CG : Character pattern Data Read for NBG0  
N1PN : Pattern name data read for NBG1, N1CG : Character pattern Data Read for NBG1  
N3PN : Pattern name data read for NBG3, N3CG : Character pattern Data Read for NBG3  
N1CE: NBG1 vertical cell scroll table data read, CPU : CPU Read/Write  
NA : No access

Figure 3.8 VRAM Cycle Pattern Selection





## VRAM Cycle Pattern Register

The VRAM cycle pattern register controls the VRAM access during the display interval. It is a 16-bit write only register with addresses from 180010H to 18001EH. Because the value is cleared to 0 after the power is turned on or reset, it must be reset.

	15	14	13	12	11	10	9	8
CYCA0L	VCP0A03	VCP0A02	VCP0A01	VCP0A00	VCP1A03	VCP1A02	VCP1A01	VCP1A00
180010H	7	6	5	4	3	2	1	0
	VCP2A03	VCP2A02	VCP2A01	VCP2A00	VCP3A03	VCP3A02	VCP3A01	VCP3A00
	15	14	13	12	11	10	9	8
CYCA0U	VCP4A03	VCP4A02	VCP4A01	VCP4A00	VCP5A03	VCP5A02	VCP5A01	VCP5A00
180012H	7	6	5	4	3	2	1	0
	VCP6A03	VCP6A02	VCP6A01	VCP6A00	VCP7A03	VCP7A02	VCP7A01	VCP7A00
	15	14	13	12	11	10	9	8
CYCA1L	VCP0A13	VCP0A12	VCP0A11	VCP0A10	VCP1A13	VCP1A12	VCP1A11	VCP1A10
180014H	7	6	5	4	3	2	1	0
	VCP2A13	VCP2A12	VCP2A11	VCP2A10	VCP3A13	VCP3A12	VCP3A11	VCP3A10
	15	14	13	12	11	10	9	8
CYCA1U	VCP4A13	VCP4A12	VCP4A11	VCP4A10	VCP5A13	VCP5A12	VCP5A11	VCP5A10
180016H	7	6	5	4	3	2	1	0
	VCP6A13	VCP6A12	VCP6A11	VCP6A10	VCP7A13	VCP7A12	VCP7A11	VCP7A10
	15	14	13	12	11	10	9	8
CYCB0L	VCP0B03	VCP0B02	VCP0B01	VCP0B00	VCP1B03	VCP1B02	VCP1B01	VCP1B00
180018H	7	6	5	4	3	2	1	0
	VCP2B03	VCP2B02	VCP2B01	VCP2B00	VCP3B03	VCP3B02	VCP3B01	VCP3B00
	15	14	13	12	11	10	9	8
CYCB0U	VCP4B03	VCP4B02	VCP4B01	VCP4B00	VCP5B03	VCP5B02	VCP5B01	VCP5B00
18001AH	7	6	5	4	3	2	1	0
	VCP6B03	VCP6B02	VCP6B01	VCP6B00	VCP7B03	VCP7B02	VCP7B01	VCP7B00
	15	14	13	12	11	10	9	8
CYCB1L	VCP0B13	VCP0B12	VCP0B11	VCP0B10	VCP1B13	VCP1B12	VCP1B11	VCP1B10
18001CH	7	6	5	4	3	2	1	0
	VCP2B13	VCP2B12	VCP2B11	VCP2B10	VCP3B13	VCP3B12	VCP3B11	VCP3B10
	15	14	13	12	11	10	9	8
CYCB1U	VCP4B13	VCP4B12	VCP4B11	VCP4B10	VCP5B13	VCP5B12	VCP5B11	VCP5B10
18001EH	7	6	5	4	3	2	1	0
	VCP6B13	VCP6B12	VCP6B11	VCP6B10	VCP7B13	VCP7B12	VCP7B11	VCP7B10

Table 3.5 shows access command that corresponds to the content of the VRAM access during 1 cycle.

**Table 3.5 Access command**

Access Command Value				VRAM Access
VCPnxx3	VCPnxx2	VCPnxx1	VCPnxx0	
0	0	0	0	NBG0 Pattern Name Data Read
0	0	0	1	NBG1 Pattern Name Data Read
0	0	1	0	NBG2 Pattern Name Data Read
0	0	1	1	NBG3 Pattern Name Data Read
0	1	0	0	NBG0 Character Pattern Data Read
0	1	0	1	NBG1 Character Pattern Data Read
0	1	1	0	NBG2 Character Pattern Data Read
0	1	1	1	NBG3 Character Pattern Data Read
1	0	0	0	Setting not allowed
1	0	0	1	Setting not allowed
1	0	1	0	Setting not allowed
1	0	1	1	Setting not allowed
1	1	0	0	NBG0 Vertical Cell Scroll Table Data Read
1	1	0	1	NBG1 Vertical Cell Scroll Table Data Read
1	1	1	0	CPU Read/Write
1	1	1	1	No Access

**Note:** n: 0 to 7 (corresponds to access timing T0 to T7)  
 xx: A0, A1, B0, B1 (corresponds to VRAM-A0, VRAM-A1, VRAM-B0, VRAM-B1)

**VRAM cycle pattern (for VRAM-A0) bit: VRAM cycle pattern bit (VCP0A00 to VCP0A03, VCP1A00 to VCP1A03, VCP2A00 to VCP2A03, VCP3A00 to VCP3A03, VCP4A00 to VCP4A03, VCP5A00 to VCP5A03, VCP6A00 to VCP6A03, VCP7A00 to VCP7A03)**

Sets the access command of VRAM access that performs in VRAM-A0 (or VRAM-A) timing T0 to T7.



VCP0A00~VCP0A03	180010H	Bit 12~15	VRAM-A0 (or VRAM-A) Timing for T0
VCP1A00~VCP1A03	180010H	Bit 8~11	VRAM-A0 (or VRAM-A) Timing for T1
VCP2A00~VCP2A03	180010H	Bit 4~7	VRAM-A0 (or VRAM-A) Timing for T2
VCP3A00~VCP3A03	180010H	Bit 0~3	VRAM-A0 (or VRAM-A) Timing for T3
VCP4A00~VCP4A03	180012H	Bit 12~15	VRAM-A0 (or VRAM-A) Timing for T4
VCP5A00~VCP5A03	180012H	Bit 8~11	VRAM-A0 (or VRAM-A) Timing for T5
VCP6A00~VCP6A03	180012H	Bit 4~7	VRAM-A0 (or VRAM-A) Timing for T6
VCP7A00~VCP7A03	180012H	Bit 0~3	VRAM-A0 (or VRAM-A) Timing for T7

**VRAM cycle pattern (for VRAM-A1) bit: VRAM cycle pattern bit (VCP0A10 to VCP0A13, VCP1A10 to VCP1A13, VCP2A10 to VCP2A13, VCP3A10 to VCP3A13, VCP4A10 to VCP4A13, VCP5A10 to VCP5A13, VCP6A10 to VCP6A13, VCP7A10 to VCP7A13)**

Sets the access command of the VRAM access that performs in VRAM-A1 timing T0 to T7.

VCP0A10~VCP0A13	180014H	Bit 12~15	VRAM-A1 Timing for T0
VCP1A10~VCP1A13	180014H	Bit 8~11	VRAM-A1 Timing for T1
VCP2A10~VCP2A13	180014H	Bit 4~7	VRAM-A1 Timing for T2
VCP3A10~VCP3A13	180014H	Bit 0~3	VRAM-A1 Timing for T3
VCP4A10~VCP4A13	180016H	Bit 12~15	VRAM-A1 Timing for T4
VCP5A10~VCP5A13	180016H	Bit 8~11	VRAM-A1 Timing for T5
VCP6A10~VCP6A13	180016H	Bit 4~7	VRAM-A1 Timing for T6
VCP7A10~VCP7A13	180016H	Bit 0~3	VRAM-A1 Timing for T7

When VRAM is not partitioned in two, the value of this register is ignored.

**VRAM cycle pattern (for VRAM-B0) bit: VRAM cycle pattern bit (VCP0B00 to VCP0B03, VCP1B00 to VCP1B03, VCP2B00 to VCP2B03, VCP3B00 to VCP3B03, VCP4B00 to VCP4B03, VCP5B00 to VCP5B03, VCP6B00 to VCP6B03, VCP7B00 to VCP7B03)**

Sets the access command of VRAM access that performs in VRAM-B0 (or VRAM-B) timing T0 to T7.

VCP0B00~VCP0B03	180018H	Bit 12~15	VRAM-B0 (or VRAM-B) Timing for T0
VCP1B00~VCP1B03	180018H	Bit 8~11	VRAM-B0 (or VRAM-B) Timing for T1
VCP2B00~VCP2B03	180018H	Bit 4~7	VRAM-B0 (or VRAM-B) Timing for T2
VCP3B00~VCP3B03	180018H	Bit 0~3	VRAM-B0 (or VRAM-B) Timing for T3
VCP4B00~VCP4B03	18001AH	Bit 12~15	VRAM-B0 (or VRAM-B) Timing for T4
VCP5B00~VCP5B03	18001AH	Bit 8~11	VRAM-B0 (or VRAM-B) Timing for T5
VCP6B00~VCP6B03	18001AH	Bit 4~7	VRAM-B0 (or VRAM-B) Timing for T6
VCP7B00~VCP7B03	18001AH	Bit 0~3	VRAM-B0 (or VRAM-B) Timing for T7

**VRAM cycle pattern (for VRAM-B1) bit: VRAM cycle pattern bit (VCP0B10 to VCP0B13, VCP1B10 to VCP1B13, VCP2B10 to VCP2B13, VCP3B10 to VCP3B13, VCP4B10 to VCP4B13, VCP5B10 to VCP5B13, VCP6B10 to VCP6B13, VCP7B10 to VCP7B13).**

Sets the access command of VRAM access that performs in VRAM-B1 timing T0 to T7.

VCP0B10~VCP0B13	18001CH	Bit 12~15	VRAM-B1 Timing for T0
VCP1B10~VCP1B13	18001CH	Bit 8~11	VRAM-B1 Timing for T1
VCP2B10~VCP2B13	18001CH	Bit 4~7	VRAM-B1 Timing for T2
VCP3B10~VCP3B13	18001CH	Bit 0~3	VRAM-B1 Timing for T3
VCP4B10~VCP4B13	18001EH	Bit 12~15	VRAM-B1 Timing for T4
VCP5B10~VCP5B13	18001EH	Bit 8~11	VRAM-B1 Timing for T5
VCP6B10~VCP6B13	18001EH	Bit 4~7	VRAM-B1 Timing for T6
VCP7B10~VCP7B13	18001EH	Bit 0~3	VRAM-B1 Timing for T7

When VRAM is not partitioned into two areas, the value of this register is ignored.



### 3.4 Color RAM Mode

With 32 Kbits (2 Kword) of color RAM, color data that is stored is used for all scroll screens and palette format sprites. The color data selects and stores either RGB-5 bit (15 bit data) or RGB-8 bit (24 bit data). In addition, when dividing it into 16K bits (1K word) and storing various color data of the same type, the expansion color calculation function can also be used. There are three methods for storing color data in color RAM:

- (1) Mode 0: RGB in each of 5 bits for a total of 15 bits, 1024 color settings
- (2) Mode 1: RGB in each of 5 bits for a total of 15 bits, 2048 color settings
- (3) Mode 2: RGB in each of 8 bits for a total of 24 bits, 1024 color settings

Because color data must be set to RGB-8 bit when it is output, a 0 will be added to the lowest 3 bits if RGB-5 bit color data is stored in the color RAM, . When the special color calculation mode is set to mode 3, the most significant bit of color RAM data becomes the color calculation enable bit. See “12.3 Special Color Calculation Function” about the special color calculation mode.

Figure 3.9 shows the color data configuration of the color RAM.

Data set for RGB 5-bit

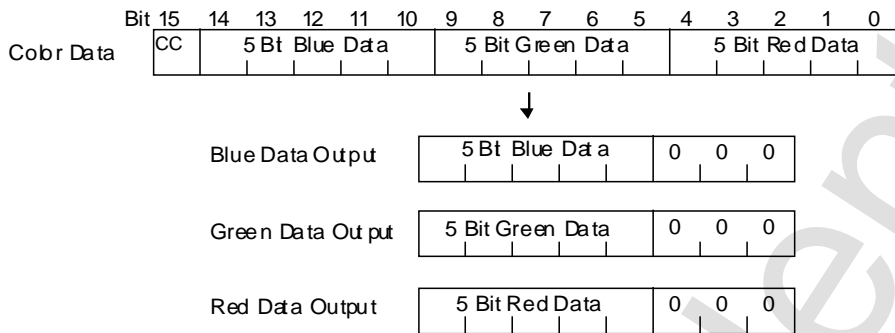

Note: The MSB CC is enable bit when special color calculation mode is mode 3

Data set for RGB 8-bit

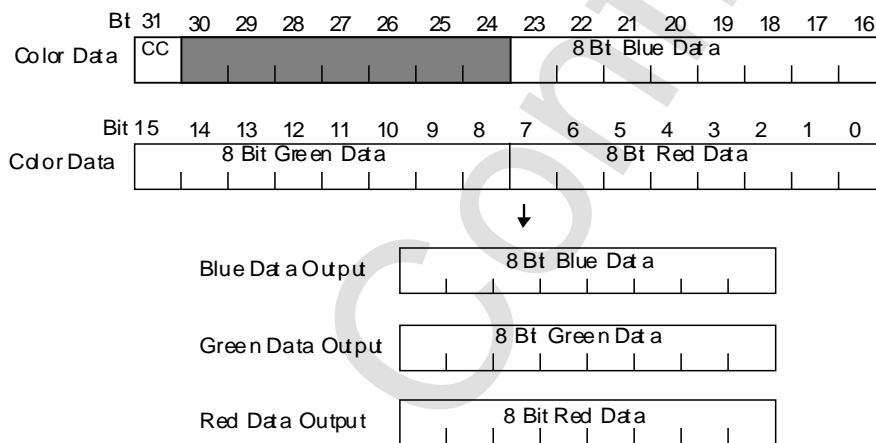

Note: The MSB CC is enable bit when special color calculation mode is mode 3.  
Shaded bit areas are ignored.

**Figure 3.9 Color data configuration on the color RAM**



Color data written to the color RAM is illustrated in Figure 3.10.

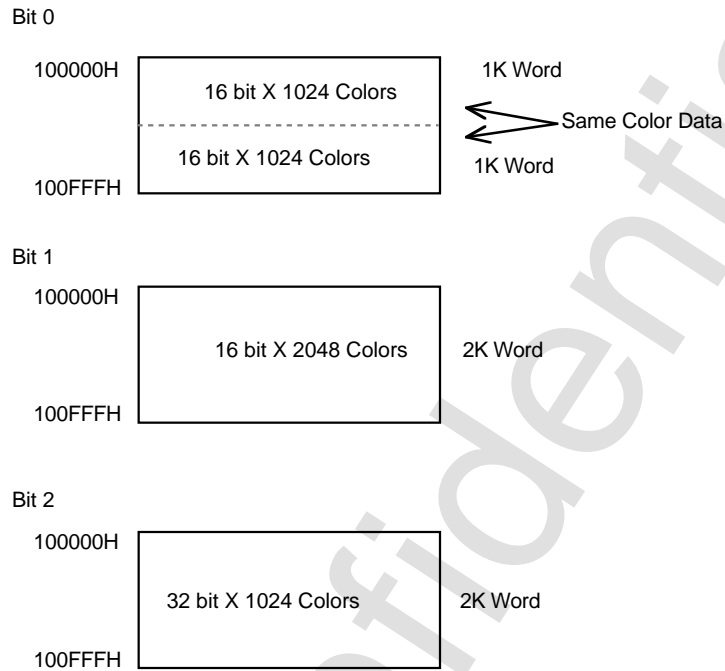

Figure 3.10 Color Data of the Color RAM

### RAM Control Register

The RAM control register selects the bank partitions of the VRAM, the purpose of using the rotation scroll screen of VRAM, and the color RAM mode. It is a read/write 16-bit register and is at the 18000EH address. Also, because the value is cleared to 0, it must be set after the power is turned on or reset.

	15	14	13	12	11	10	9	8
RAMCTL	CRKTE	~	CRMD1	CRMD0	~	~	VRBMD	VRAMD
18000EH	7	6	5	4	3	2	1	0
	RDBSB11	RDBSB10	RDBSB01	RDBSB00	RDBSA11	RDBSA10	RDBSA01	RDBSA00

#### Color RAM Coefficient Table Enable Bit (CRKTE), Bit 15

See "6.4 Coefficient Table Control."

**Color RAM mode bit (CRMD1, CRMD0), bits 13 and 12**

Selects the color RAM mode. See “3.4 Color RAM mode.”

Set the Color RAM mode to mode 1 when the CRKTE bit is 1. At that time, color data can no longer be stored because the second half of the color RAM (100800H ~ 100FFFH) is used for the coefficient table data.

CRMD1	CRMD0	Mode	Process
0	0	0	RGB each 5 bits, 1024 color settings
0	1	1	RGB each 5 bits, 2048 color settings
1	0	2	RGB each 8 bits, 1024 color settings
1	1	-	Setting not allowed

Saving color data to the color RAM must be done after these bits have been set. When mode 0 is set, data written to the first half of the color RAM will be written to the second half at the same time.

VRAM mode bit (VRBMD and VRAMD), bits 9 and 8. (See “3.2 VRAM Bank Partition.”)

**Rotation data bank select bit: Data bank select bit (RDBSA01, RDBSA00, RDBSA11, RDBSA10, RDBSB01, RDBSB00, RDBSB11, RDBSB10)**

Designates the use objective of the VRAM of the rotation scroll screen. This bit is only in effect when the rotation scroll screen is displayed. (See “6.2 Rotation Scroll Screen Display Control.”)





# Chapter 4 Scroll Screen

4.1 Screen Display Control .....	48
Screen Display Enable Register .....	48
4.2 Scroll Screen Structure .....	50
Cell Format .....	50
Bit Map Format .....	52
4.3 Cell .....	53
Character Color Number .....	53
Cell Data Configuration .....	53
Transparent Dots .....	57
RGB Format Dot Data .....	58
4.4 Character Patterns .....	59
Character Size and Cell Arrangement .....	59
4.5 Character Control Register .....	60
4.6 Pattern Name Table (Page) .....	64
Pattern Name Table Data Configuration .....	64
Pattern Name Data .....	69
Character Number .....	74
Palette Number .....	74
Special Function Bit .....	74
Reverse (Flip) Function Bit .....	75
Pattern Name Control Register .....	76
4.7 Planes .....	79
Plane Size .....	79
Plane Size Register .....	80
4.8 Maps .....	82
Map Selection Register .....	82
Map Size .....	84
Map Offset Register .....	85
Normal Scroll Screen Map Register .....	87
Rotation Scroll Surface Map Register .....	89
4.9 Bit Maps .....	93
Bit Map Size .....	93
Bit Map Color Number .....	93
Bit Map Pattern .....	95
Bit Map Palatte Number .....	111
Special Function Bit .....	111
Bit Map Palatte Number Register .....	112
4.10 Display Area .....	114
Display Area .....	114
Screen-Over Process .....	115
Display-Over Pattern Name .....	115
Screen-Over Pattern Name Register .....	116
4.11 Mosaic Process .....	117
Mosaic Control Register .....	118

## 4.1 Screen Display Control

The scroll screen selects screens not displayed by controlling VRAM access used in the display of each screen, and can also indicate whether to invalidate the dot color code (transparency code) in each screen, which are the transparent dots of the screen being displayed.

### Screen Display Enable Register

The screen display enable register controls the screen display and transparency code. With a write-only 16-bit register, its address is 180020H. Because the value of the register is cleared to 0 after power on or reset, the value must be set.

	15	14	13	12	11	10	9	8
BGON	~	~	~	R0TPON	N3TPON	N2TPON	N1TPON	N0TPON
180020H	7	6	5	4	3	2	1	0
	~	~	R1ON	R0ON	N3ON	N2ON	N1ON	N0ON

#### Transparent display enable bit (N0TPON, N1TPON, N2TPON, N3TPON, R0TPON)

Designates whether to nullify the transparency code. For more specifics about the transparency code see Transparent Dots in section "4.3 Cell."

N0TPON	180020H	Bit 8	For NBG0 (or RBG1)
N1TPON	180020H	Bit 9	For NBG1 (or EXBG)
N2TPON	180020H	Bit 10	For NBG2
N3TPON	180020H	Bit 11	For NBG3
R0TPON	180020H	Bit 12	For RBG0

xxTPON	Process
0	Validates transparency code (transparency code dots become transparent)
1	Invalidates transparency code (transparency code dots are displayed according to data values)

**Note:** N0, N1, N2, N3, or R0 is entered into bit name for xx.



**Screen display enable bit: On bit (N0ON, N1ON, N2ON, N3ON, R0ON, R1ON)**

Designates whether to display each scroll screen.

N0TPON	180020H	Bit 8	For NBG0 (or RBG1)
N1TPON	180020H	Bit 9	For NBG1 (or EXBG)
N2TPON	180020H	Bit 10	For NBG2
N3TPON	180020H	Bit 11	For NBG3
R0TPON	180020H	Bit 12	For RBG0

xxTPON	Process
0	Validates transparency code (transparency code dots become transparent)
1	Invalidates transparency code (transparency code dots are displayed according to data values)

**Note:** N0, N1, N2, N3, R0, or R1 is entered into bit name xx.

When the screen access command (which has a 0 bit) is set in the VRAM cycle pattern register, the access command is ignored and the VRAM access for displaying the screen will not be performed.

When R0ON is 0, do not set R1ON at 1.

When both R0ON and R1ON are 1, the normal scroll screen can no longer be displayed. At this time, VRAM-B0 is fixed in RAM used for RBG1 character pattern tables; and VRAM-B1 is fixed in RAM used for RBG1 pattern name tables.

When a specific screens can no longer be displayed by register settings, the screen bit should be set to 0. For example, when both R0ON and R1ON are 1, set the N0ON, N1ON, N2ON, N3ON bits at 0. See section "6.2 Rotation Scroll Surface Display Control" for more about rotation scroll surfaces.

## 4.2 Scroll Screen Structure

The scroll screen has two screen formats, the cell format and the bit map format.

### Cell Format

The cell format scroll screen is composed of picture pattern “cells” that are 8 H dots by 8 V dots; cells are arranged in 1 H X 1 V or 2 H X 2 V to form “character patterns.” A “page” is an arrangement of character patterns in 32 H X 32 V or 64 H X 64 V. A “plane” is an arrangement of pages 1 H X 1 V, 2 H X 1 V, or 2 H X 2 V. A “map” is an arrangement of planes 2 H X 2 V (for normal scroll screens), or 4 H X 4 V (for rotation scroll surface). Figure 4.1 shows the cell format configuration of the scroll screen.

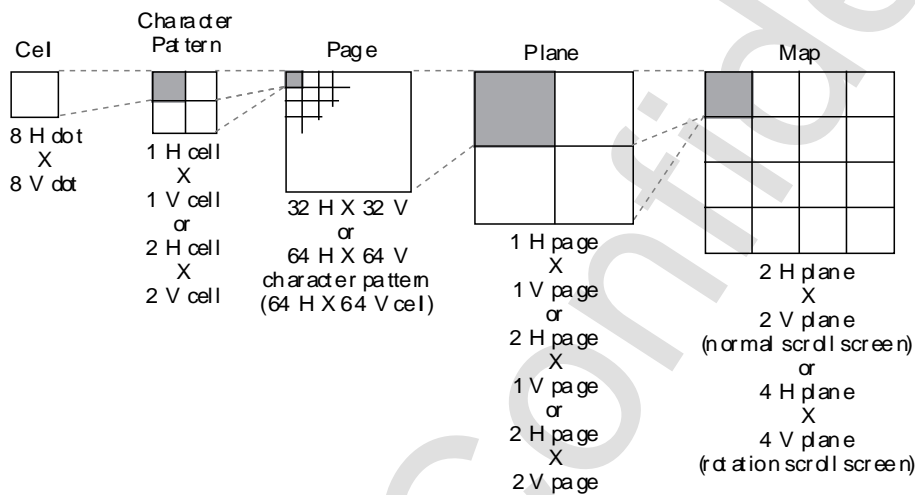
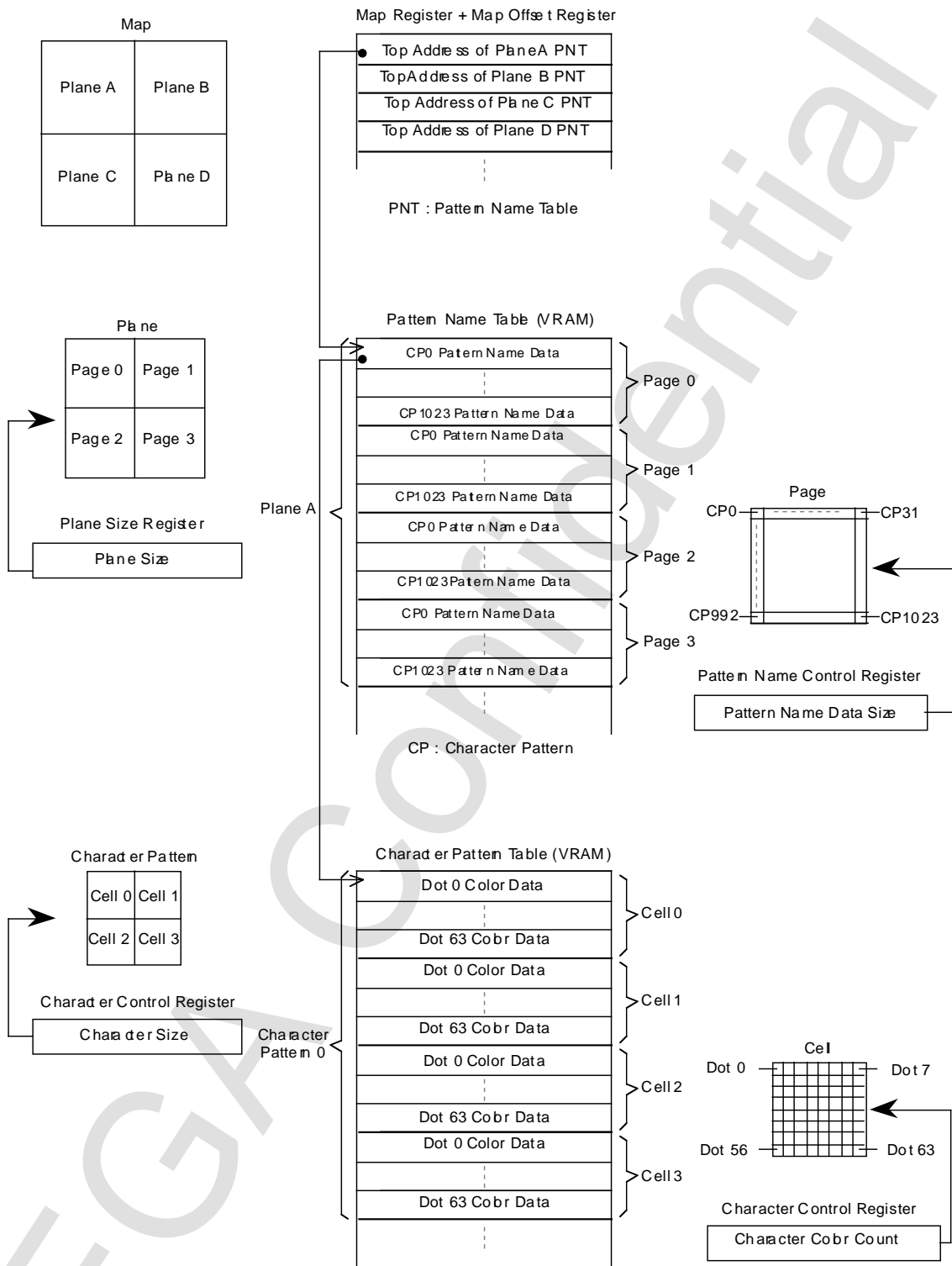

Figure 4.1 Scroll screen configuration of the cell format

Dot color data stored as character pattern tables in VRAM becomes cell data. Color data is composed of 4, 8, 16, or 32-bit character color. Character pattern data is cell data arranged in one or four pieces. Page data is character pattern name data (address of character pattern table) stored as a pattern name table. Page data arranged in one, two, or four pieces is a plane. The map selects the lead address of the pattern name table in the map register and map offset register. Figure 4.2 shows the configuration of a cell format of the scroll screen and corresponding data settings.





Note: Character pattern and plane size vary depending on the register setting; map size varies depending on the scroll screen type. The above figure is an example of the case when character pattern is 2 H cells X 2 V cells. The plane is 2 H pages X 2 V pages and normal scroll screen (2 H planes X 2 V planes).

Figure 4.2 Scroll screen configuration of cell format and corresponding data settings.

## Bit Map Format

The scroll screen of the bit map format is composed of a bit map pattern 512 H (or 1024) dots and 256 V (or 512) dots. When a screen is displayed by the bit map format, the size of the bit map must be set in the register and the set size of the bit map pattern must be stored in VRAM. Figure 4.3 shows the scroll screen configuration of the bit map format. Figure 4.4 shows the relationship of the register and the scroll screen of the bit map format.

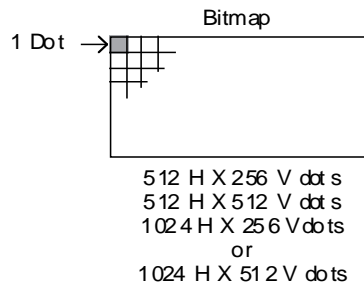

Figure 4.3 Scroll screen configuration of the bit map format

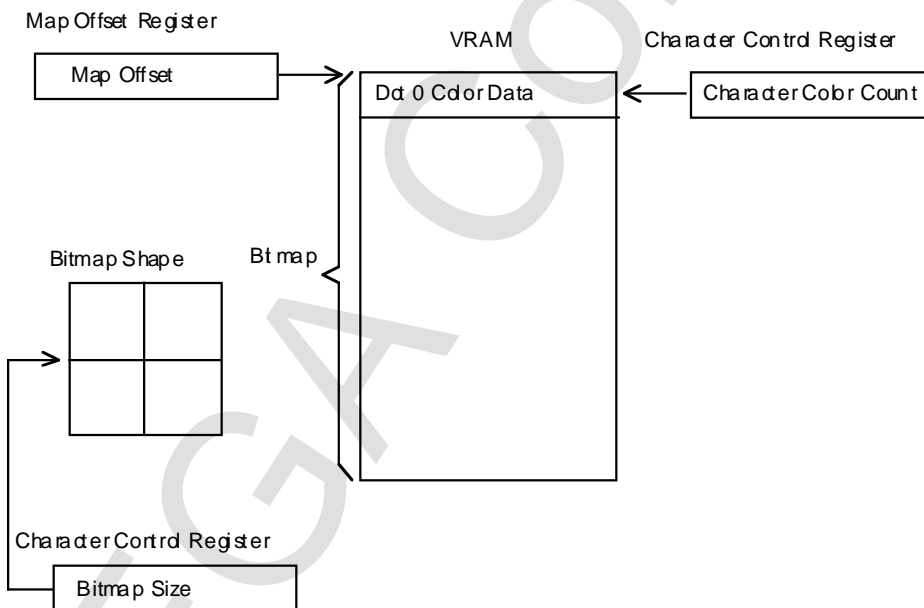

Figure 4.4 Relationship of bit map format scroll screen and data settings



### 4.3 Cell

The cell is a picture pattern 8 H dots by 8 V dots, and is stored in VRAM. The character color count (number of colors per one cell) can be selected from among 16, 256, 2048, 32,768, or 16,777,216 colors. The amount of RAM required in the size of each dot color data and in data of one cell changes according to the color count.

#### Character Color Number

There are two color formats for displaying characters: the palette format and the RGB format. The palette format treats display color data as color RAM address data selected by the dot color code within cell data, and palette number within pattern name data. The RGB format treats cell data as display color data. Table 4.1 shows the character color count and the number of bits per dot at that time in the various color formats.

**Table 4.1 Character color count and dot data size**

Color Format	Character Color Count	Bit Count for 1 Dot
Palette Format	16 colors	4 bits
	256 colors	8 bits
	2048 colors	16 bits (Only use lower 11 bits)
RGB Format	32,768 colors	16 bits
	16,770,000 colors	32 bits (Only use MSB and lower 24 bits)

**Note:** In color RAM modes 0 and 2, 2048-color becomes 1024-color.

#### Cell Data Configuration

The data configuration of each cell stored in a character pattern table changes according to the bit count of one dot. The boundary when stored in VRAM is 20H and has no relationship to the bit count of one dot. Cell data configuration is shown in Table 4.2 and Figure 4.5.

**Table 4.2 Cell Data Configuration**

Bit Count for 1 Dot	Cell Data	Boundary
4 bits/dot	32 bytes/cell	20H byte
8 bits/dot	64 bytes/cell	20H byte
16 bits/dot	128 bytes/cell	20H byte
32 bits/dot	256 bytes/cell	20H byte

(1) 4 bits/ dot (32 bytes/cell)

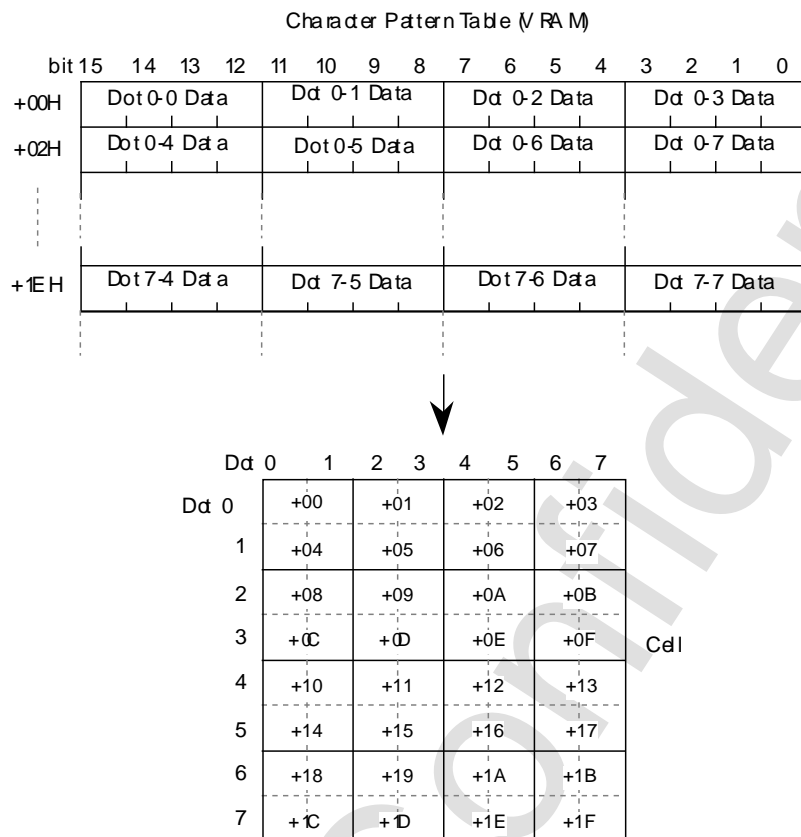

- Note 1: The upper left notation in the cell is dot 0-0, to the right are dot 0-1, dot 0-2, dot 0-3 ...
- Note 2: Numbers in the cells are VRAM addresses (Hexadecimal) of dot (2 dots) data with VRAM address of dot 0-0, 0-1 data as the reference.

**Figure 4.5 Data configuration of cells by character color count**





(2) 8 bits/dot (64 bytes/cell)

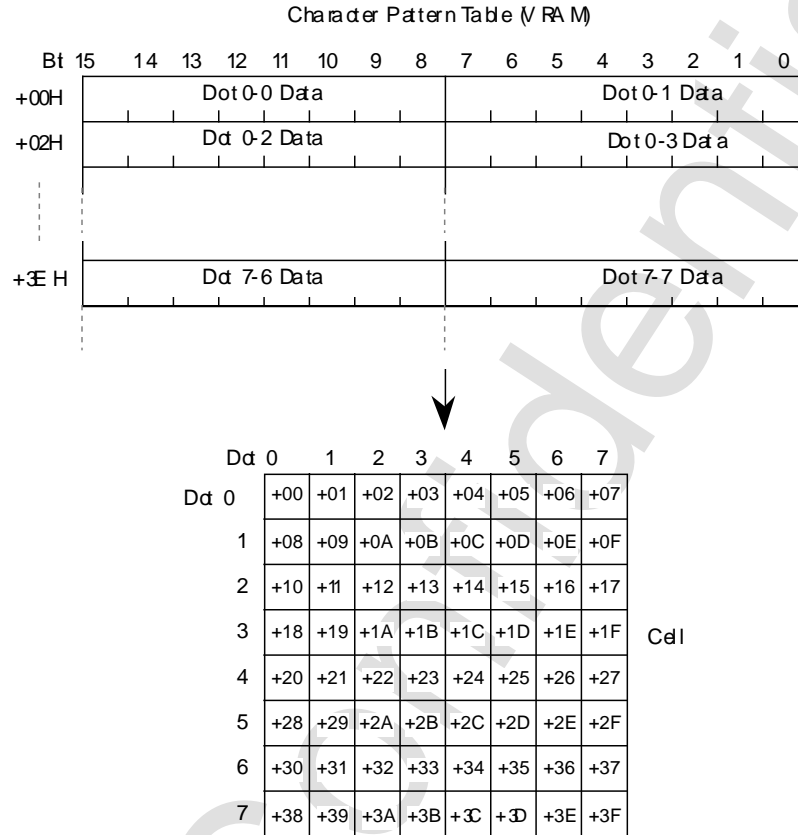

Note 1: The upper left notation in the cell is dot 0-0, to the right are dot 0-1, dot 0-2, dot 0-3 ...

Note 2: Numbers in the cells are VRAM addresses (Hexadecimal) of dot data, with VRAM address of dot 0-0 data as the reference.

Figure 4.5 Data configuration of cells by character color count (continued)

(3) 16 bits/dot (128 bytes/cel)

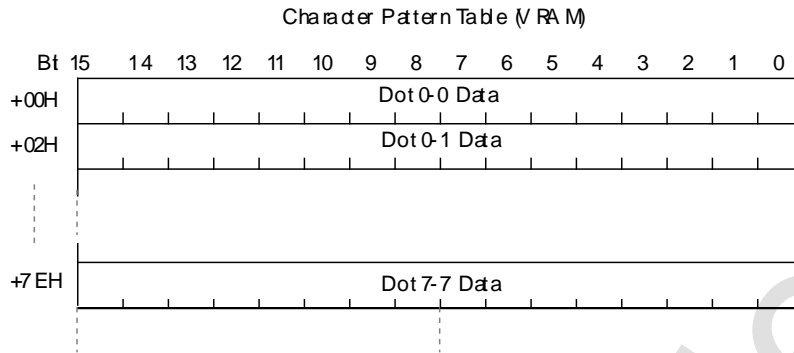

↓

	Dot 0	1	2	3	4	5	6	7	
Dot 0	+00	+02	+04	+06	+08	+0A	+0C	+0E	
1	+10	+12	+14	+16	+18	+1A	+1C	+1E	
2	+20	+22	+24	+26	+28	+2A	+2C	+2E	
3	+30	+32	+34	+36	+38	+3A	+3C	+3E	Cell
4	+40	+42	+44	+46	+48	+4A	+4C	+4E	
5	+50	+52	+54	+56	+58	+5A	+5C	+5E	
6	+60	+62	+64	+66	+68	+6A	+6C	+6E	
7	+70	+72	+74	+76	+78	+7A	+7C	+7E	

Note 1: The upper left notation in the cell is dot 0-0; to the right are dot 0-1, dot 0-2, dot 0-3, ...

Note 2: Numbers in the cells are VRAM addresses (Hexadecimal) of dot data, with VRAM address of dot 0-0 data as the reference.

**Figure 4.5 Data configuration of cells by character color count (continued)**



(4) 32 bits/dot (256 bytes/cel)

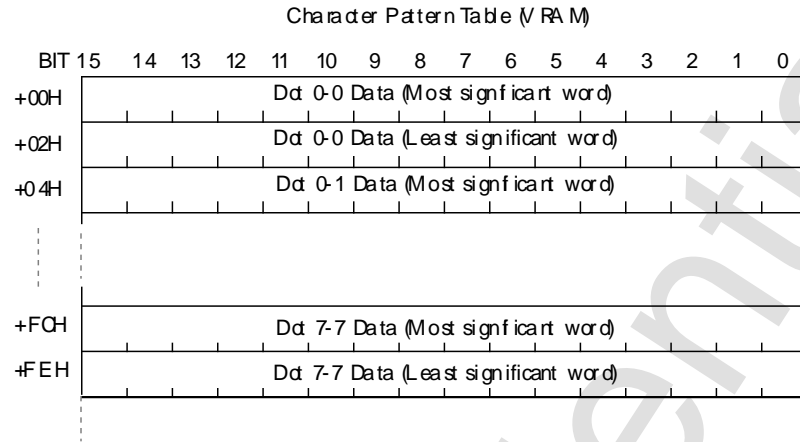

↓

	Dot 0	1	2	3	4	5	6	7	
Dot 0	+00	+04	+08	+0C	+10	+14	+18	+1C	
1	+20	+24	+28	+2C	+30	+34	+38	+3C	
2	+40	+44	+48	+4C	+50	+54	+58	+5C	
3	+60	+64	+68	+6C	+70	+74	+78	+7C	Cell
4	+80	+84	+88	+8C	+90	+94	+98	+9C	
5	+A0	+A4	+A8	+AC	+B0	+B4	+B8	+BC	
6	+C0	+C4	+C8	+CC	+D0	+D4	+D8	+DC	
7	+E0	+E4	+E8	+EC	+F0	+F4	+F8	+FC	

Note 1: The upper left notation in the cell is ddt 0-0, to the right are dot 0-1, dot 0-2, dot 0-3, ...

Note 2: Numbers in the cells are VRAM addresses (Hexadecimal) of dot data (MSW), with VRAM address of dot 0-0 data (MSW) as the reference.

**Figure 4.5 Data configuration of cells by character color count (continued)**

### Transparent Dots

Dot color code, which are transparent dots (transparency code), changes according to the color format. When the color format is the palette format, the transparent dot applies when all bits per one dot is 0; when the RGB format, the transparent dot applies when the most significant bit of the dot data is 0.

When in the palette format, lead color data of the palette corresponds to the transparency code; therefore, it normally cannot be used. If the transparency code is nullified, this color data can be used. Control is done by the screen display enable register. Table 4.3 shows the transparent dot data values.

**Table 4.3 Transparent dot data values**

Color Format	Character Color Count	Bit Count for 1 Dot	Transparency Code
Palette Format	16 colors	4 bits/dot	0H (4 bit)
	256 colors	8 bits/dot	00H (8 bit)
	2048 colors	16 bits/dot	000H (lower 11 bits)
RGB Format	32,768 colors	16 bits/dot	MSB (bit 15) is 0
	16,770,000 colors	32 bits/dot	MSB (bit 31) is 0

**RGB Format Dot Data**

When the color format is the RGB format, the character color count can be selected from two groups: 32,768 colors and 16,770,000 colors. 16,770,000 colors are designated by RGB 8-bit; but 32,768 colors designate the higher 5 bits within RGB 8-bit, and the lower 3 bits are set to 0. The transparency bit designates whether it is a transparent dot. The most significant bit is a transparent dot when 0. In the screen display enable register, when the transparency code is indicated as invalid, the transparent bit is ignored. Figure 4.6 shows the dot data of the RGB format.

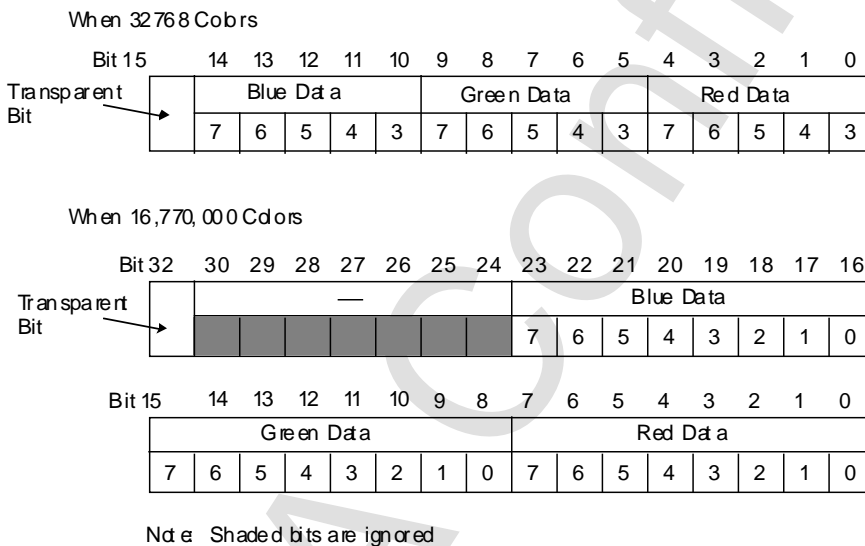

**Figure 4.6 RGB format dot data**



## 4.4 Character Patterns

Character patterns are perfect squares composed of 1 or 4 cells; the size is specified in their respective registers.

### Character Size and Cell Arrangement

When the character pattern is composed of four cells, the data of a cell that is used in the same character pattern must be linked to and stored in a character pattern table. The relationship of cell arrangement by character size (cell number of character pattern) and character pattern table is shown in Figure 4.7.

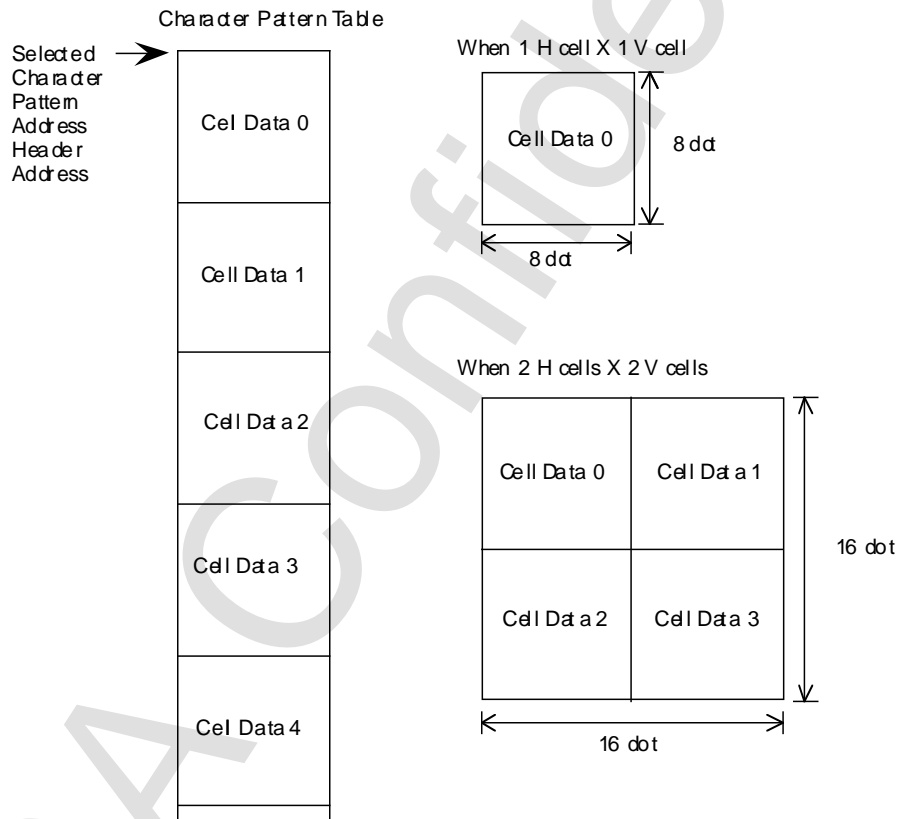

Figure 4.7 Cell Arrangement by Character Size

## 4.5 Character Control Register

The character control register selects cell and bit map formats, the number of character (bit map) colors, and the size of the character pattern or bit map. This register is a write only 16-bit register located in addresses 180028H to 18002AH. Because the value of the register is cleared to 0 after the power is turned on or reset, the value must be set.

	15	14	13	12	11	10	9	8
CHCTLA 180028H	~	~	N1CHCN1	N1CHCN0	N1BMSZ1	N1BMSZ0	N1BMEN	N1CHSZ
	7	6	5	4	3	2	1	0
	~	N0CHCN2	N0CHCN1	N0CHCN0	N0BMSZ1	N0BMSZ0	N0BMEN	N0CHSZ
	15	14	13	12	11	10	9	8
CHCTLB 18002AH	~	R0CHCN2	R0CHCN1	R0CHCN0	~	R0BMSZ	R0BMEN	R0CHSZ
	7	6	5	4	3	2	1	0
	~	~	N3CHCN	N3CHSZ	~	~	N2CHCN	N2CHSZ

**Character color number bit (N0CHCN2 to N0CHCN0, N1CHCN1, N1CHCN0, N2CHCN, N3CHCN, R0CHCN2 to R0CHCN0)**

Designates the character color count of each screen, and the bit map color count when displaying by the bit map format.

N0CHCN2~N0CHCN0	180028H	Bit 6~4	For NBG0 (or RBG1)
N1CHCN1,N1CHCN0	180028H	Bit 13,12	For NBG1 (or EXBG)
N2CHCN	18002AH	Bit 1	For NBG2
N3CHCN	18002AH	Bit 5	For NBG3
R0CHCN2~R0CHCN0	18002AH	Bit 14~12	For RBG0

N0CHCN2	N0CHCN1	N0CHCN0	TV Screen Mode			Color Format
			Normal	Hi-Res	Exclusive Monitor	
0	0	0	16 colors	16 colors	16 colors	Palette Format
0	0	1	256 colors	256 colors	256 colors	Palette Format
0	1	0	2048 colors	2048 colors	2048 colors	Palette Format
0	1	1	32,786 colors	32,786 colors	32,786 colors	RGB Format
1	0	0	16,770,000 colors	Setting not allowed	Setting not allowed	RGB Format
1	0	1	Setting not allowed (Please do not set.)			
1	1	0	Setting not allowed (Please do not set.)			
1	1	1	Setting not allowed (Please do not set.)			

**Note:** Cannot be displayed by the exclusive monitor mode when used as RBG1.



N1CHCN1	N1CHCN0	TV Screen Mode			Color Format
		Normal	Hi-Res	Exclusive Monitor	
0	0	16 colors	16 colors	16 colors	Palette Format
0	1	256 colors	256 colors	256 colors	Palette Format
1	0	2048 colors	2048 colors	2048 colors	Palette Format
1	1	32,786 colors	32,786 colors	32,786 colors	RGB Format

**Note:** When used as EXBG, and when the set values are N1CHCN1 = 1, N1CHCN0 = 1 there are 16,770,000 colors

NnCHCN0	TV Screen Mode			Color Format
	Normal	Hi-Res	Exclusive Monitor	
0	16 colors	16 colors	16 colors	Palette Format
1	256 colors	256 colors	256 colors	Palette Format

**Note:** 2 or 3 is entered in bit name for n.

R0CHCN2	R0CHCN1	R0CHCN0	TV Screen Mode			Color Format
			Normal	Hi-Res	Exclusive Monitor	
0	0	0	16 colors	16 colors	Cannot Display	Palette Format
0	0	1	256 colors	256 colors	Cannot Display	Palette Format
0	1	0	2048 colors	2048 colors	Cannot Display	Palette Format
0	1	1	32,786 colors	32,786 colors	Cannot Display	RGB Format
1	0	0	16,770,000 colors	Setting not allowed	Cannot Display	RGB Format
1	0	1	Setting not allowed (Please do not set.)			
1	1	0	Setting not allowed (Please do not set.)			
1	1	1	Setting not allowed (Please do not set.)			

Depending on the color count of NBG0 and NBG1, the scroll screen that cannot be displayed will appear. When NBG0 is set at 2048 or 32,768 colors, NBG2 can no longer be displayed. When NBG0 is set at 16,770,000 colors, NBG1 to NBG3 can no longer be displayed. When NBG1 is set at 2048 or 32,768 colors, NBG3 can no longer be displayed.

**Bit map size bit (N0BMSZ1, N0BMSZ0, N1BMSZ1, N1BMSZ0, R0BMSZ)**

Designates the bit map size of each screen when display is in a bit map format.

N0BMSZ1,N0BMSZ0	180028H	Bit 3,2	For NBG0
N1BMSZ1,N1BMSZ0	180028H	Bit 11,10	For NBG1
R0BMSZ	18002AH	Bit 10	For RBG0

NnBMSZ1	NnBMSZ0	Bitmap Size	
0	0	512 H dots X 256 V dots	
0	1	512 H dots X 512 V dots	
1	0	1024 H dots X 256 V dots	
1	1	1024 H dots X 512 V dots	

Note: 0 or 1 is entered in bit name for n.

ROBMSZ	Bitmap Size
0	512 H dots X 256 V dots
1	512 H dots X 512 V dots

**Bit map enable bit (N0BMEN, N1BMEN, R0BMEN)**

Designates whether to display the scroll screen in a bit map format.

N0BMEN	180028H	Bit 1	For NBG0
N1BMEN	180028H	Bit 9	For NBG1
R0BMEN	18002AH	Bit 9	For RBG0

xxBMEN	Screen Display Format
0	Cell Format
1	Bitmap Format

Note: N0, N1, or R0 is entered in bit name for xx.





**Character size bit (N0CHSZ, N1CHSZ, N2CHSZ, N3CHSZ, R0CHSZ)**

Designates the character size when the scroll screen is in a cell format.

N0CHSZ	180028H	Bit 0	For NBG0 (or RBG1)
N1CHSZ	180028H	Bit 8	For NBG1
N2CHSZ	18002AH	Bit 0	For NBG2
N3CHSZ	18002AH	Bit 4	For NBG3
R0CHSZ	18002AH	Bit 8	For RBG0

<b>xxCHSZ</b>	<b>Character Pattern Size</b>		
0	1 H Cell X 1 V Cell		
1	2 H Cells X 2 V Cells		

**Note:** N0, N1, N2, N3, or R0 is entered in bit name for xx.

SEGA Confidential

## 4.6 Pattern Name Table (Page)

Pattern name table (or page) stores the method of arrangement when the character pattern is in a square the size of a 64 X 64 cell in the VRAM. It also arranges pattern name data in table form and stores it in VRAM. Pattern name data selects the lead address of the character pattern stored in VRAM and the control information for each character pattern. Pattern name data in a pattern name table is in one-word or two-word. When in one-word, auxiliary data of the least significant 10 bits of the pattern name control register is added to make up for insufficient bits.

### Pattern Name Table Data Configuration

The boundary stored in VRAM and VRAM capacity required in a pattern name table of 64 X 64 cells (1 page) change depending on the pattern name data size (word count) and character size. The capacity and data configuration of pattern name tables are shown in Table 4.4 and Figure 4.8.

**Table 4.4 Pattern name table capacity and page boundary of one page**

Pattern Name Data Size	Character Size	Contents of 1 Page	Boundary During VRAM Storage
1 Word	1 H Cell X 1 V Cell	8192 Bytes	2000H
	2 H Cells X 2 V Cells	2048 Bytes	800H
2 Words	1 H Cell X 1 V Cell	16,384 Bytes	4000H
	2 H Cells X 2 V Cells	4096 Bytes	1000H



- (1) Pattern Name Data Size : 1 word  
Character Pattern Size : 1 H cell X 1 V cell

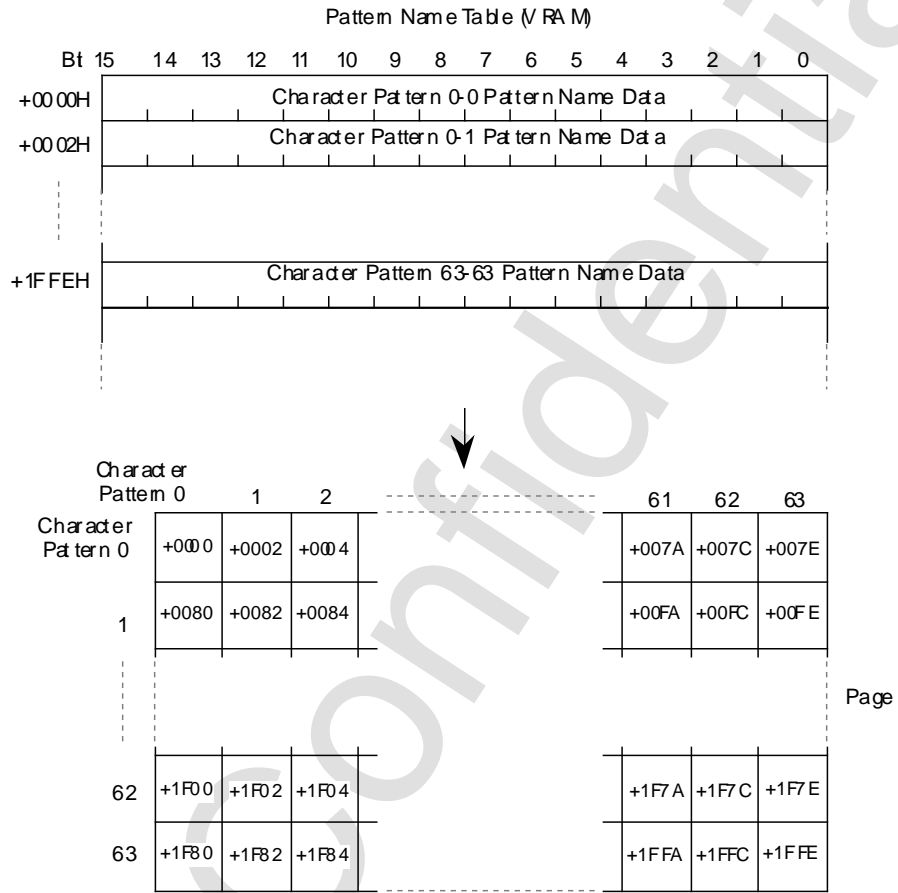

- Note 1: The upper-left notation in the page is character pattern 0-0, to the right are character patterns 0-1, 0-2, 0-3, ...
- Note 2: Numbers in the pages are VRAM addresses (Hexadecimal) of pattern name data of character patterns, with VRAM address of character pattern 0-0 pattern name data as the reference.

**Figure 4.8 Data configuration of pattern name tables**

SECRET

- (2) Pattern Name Data Size : 1 word  
Character Pattern Size : 2 H cells X 2 V cells

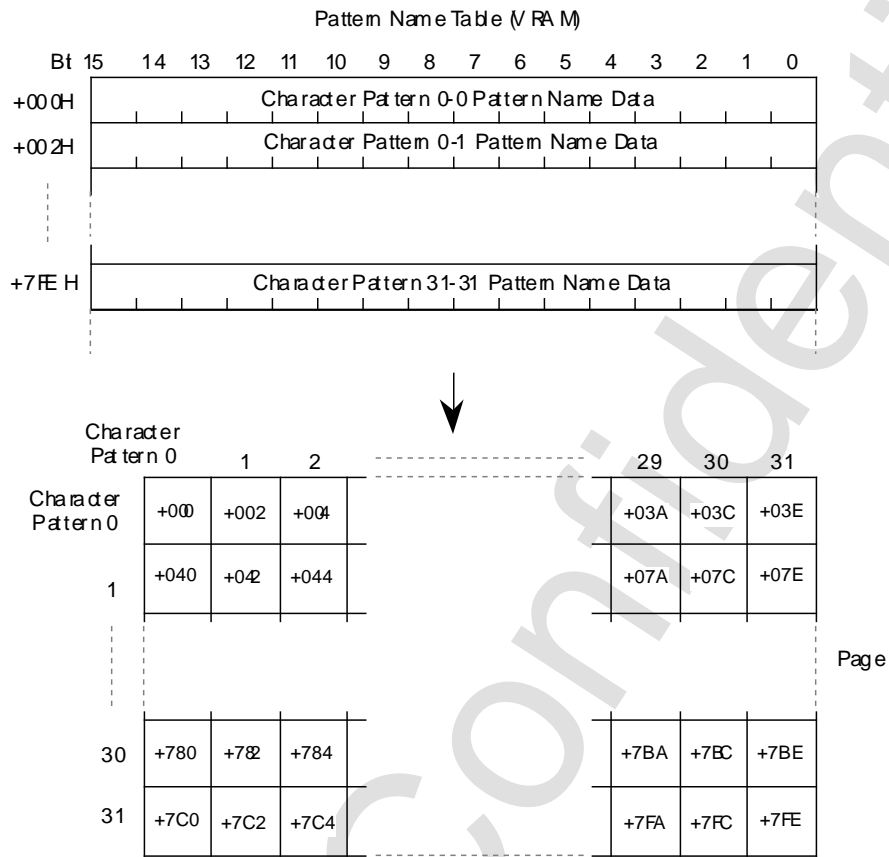

- Note 1: The upper-left notation in the page is character pattern 0-0, to the right are character patterns 0-1, 0-2, 0-3, ...
- Note 2: Numbers in the pages are VRAM addresses (Hexadecimal) of pattern name data of character patterns, with VRAM address of character pattern 0-0 pattern name data as the reference.

**Figure 4.8 Data configuration of pattern name tables (continued)**



- (3) Pattern Name Data Size : 2 words  
 Character Pattern Size : 1 H cell X 1 V cell

Pattern Name Table (VRAM)

Bit	15	14	13	12	11	10	9	8	7	6	5	4	3	2	1	0
+0000H	Character Pattern 0-0 Pattern Name Data (Most significant word)															
+0002H	Character Pattern 0-0 Pattern Name Data (Least significant word)															
+0004H	Character Pattern 0-1 Pattern Name Data (Most significant word)															
⋮	⋮															
+3FFCH	Character Pattern 63-63 Pattern Name Data (Most significant word)															
+3FFE H	Character Pattern 63-63 Pattern Name Data (Least significant word)															
⋮	⋮															

↓

Character Pattern	0	1	2	⋮	61	62	63
0	+0000 +0002	+0004 +0006	+0008 +000A	⋮	+00F4 +00F6	+00F8 +00FA	+00FC +00FE
1	+0100 +0102	+0104 +0106	+0108 +010A	⋮	+01F4 +01F6	+01F8 +01FA	+01FC +01FE
⋮	⋮	⋮	⋮	⋮	⋮	⋮	⋮
62	+3E00 +3E02	+3E04 +3E06	+3E08 +3E0A	⋮	+3EF4 +3EF6	+3EF8 +3EFA	+3EFC +3EFE
63	+3F00 +3F02	+3F04 +3F06	+3F08 +3F0A	⋮	+3FF4 +3FF6	+3FF8 +3FFA	+3FFC +3FFE

Page

- Note 1: The upper-left notation in the page is character pattern 0-0, to the right are character patterns 0-1, 0-2, 0-3, ...
- Note 2: Numbers in the pages are VRAM addresses (Hexadecimal) of pattern name data of character patterns, with VRAM address of character pattern 0-0 pattern name data as the reference.

**Figure 4.8 Data configuration of pattern name tables (continued)**

- (4) Pattern Name Data Size : 2 words  
 Character Pattern Size : 2 H cells X 2 V cells

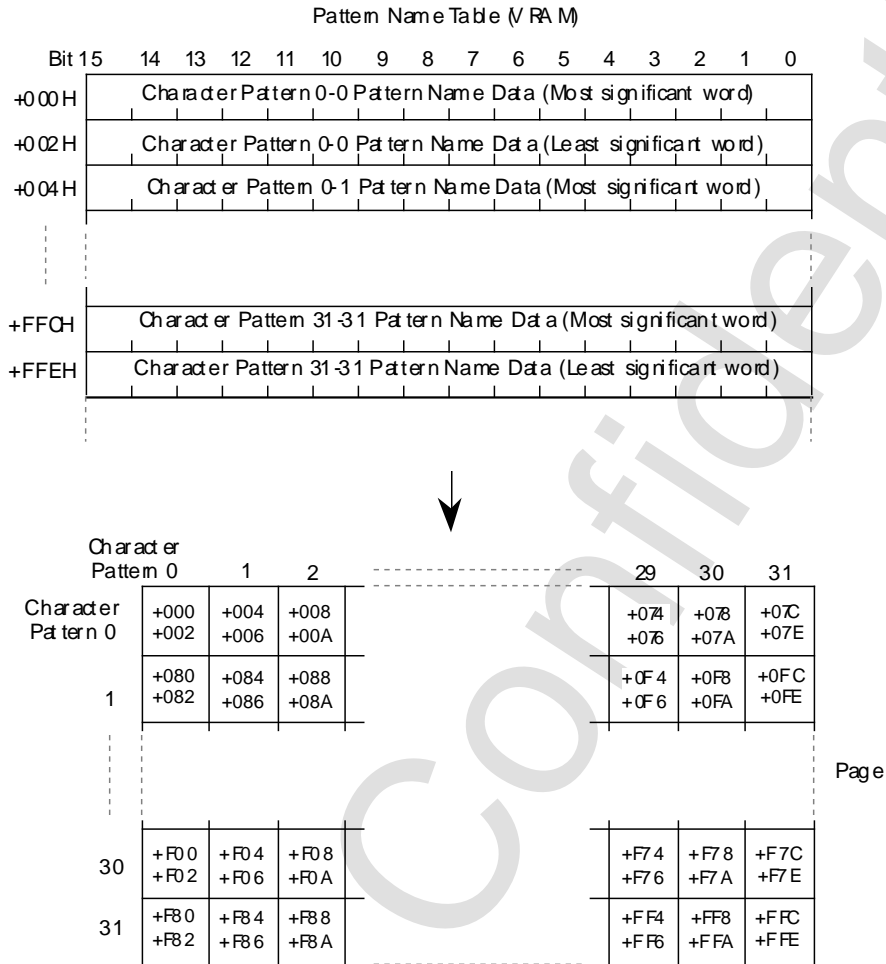

- Note 1: The upper-left notation in the page is character pattern 0-0; to the right are character patterns 0-1, 0-2, 0-3, ...
- Note 2: Numbers in the pages are VRAM addresses (Hexadecimal) of pattern name data of character patterns, with VRAM address of character pattern 0-0 pattern name data as the reference.

**Figure 4.8 Data configuration of pattern name tables (continued)**



## Pattern Name Data

Pattern name data is composed of the following four fields, for a total of 26 bits.

- Character number 15 bits
- Palette number 7 bits
- Special function bits 2 bits
- Reverse function bits 2 bits

The character number designates the address of the character pattern (VRAM). The palette number designates the address of the palette (color RAM) used by the character. The special function bits designate whether that character will use the special function. The reverse function bits designate whether to use the up-down reverse or left-right reverse functions.

The size of the pattern name data in the pattern name table can select either 1-word or 2-word. Because all required pattern name data cannot be designated when 1 word is selected, it is supplemented by auxiliary data of the least significant 10 bits of the pattern name control register. The composition of pattern name data changes depending on character size, character number color, and the character number auxiliary mode. The character number auxiliary mode designates the number of bits per character number when the pattern name table size in the pattern name table is 1-word, and whether that character can use the reverse function. Table 4.5 shows the character number auxiliary mode. Figure 4.9 shows the configuration of 2-word pattern name data, and Figure 4.10 shows the configuration of 1 word pattern name data.

**Table 4.5 Character number auxiliary mode**

Character Number Auxiliary Mode	Process
0	Character number that can be specified in pattern name data is 10 bits. Flip function can be specified in character units.
1	Character number that can be specified in pattern name data is 12 bits. Flip function cannot be used.

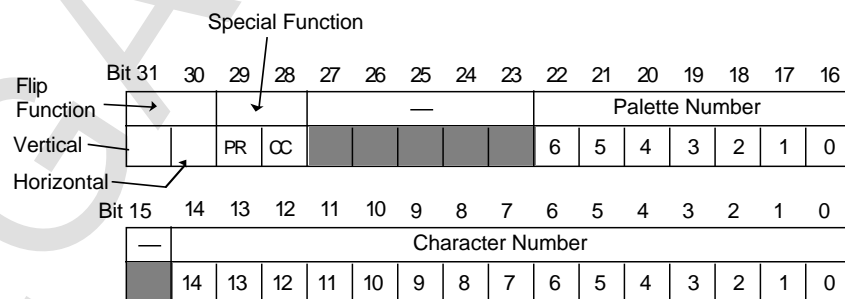

Note: Shaded bits are ignored  
 PR: Special Priority Bit  
 CC: Special Color Calculation Bit

**Figure 4.9 Bit configuration when the pattern name data is 2 word**

Table 4.6 shows the bit configuration when the pattern name data is 1 word.

**Table 4.6 Bit configuration when pattern name data is 1 word.**

Character Size	Character Color Count	Auxiliary Mode	Character Number	Palette Number	Special Function	Flip Function
1 X 1	16	0	15*1	7	2	2
1 X 1	16	1	15*2	7	2	-
1 X 1	other than 16	0	15*1	3	2	2
1 X 1	other than 16	1	15*2	3	2	-
2 X 2	16	0	15*3	7	2	2
2 X 2	16	1	15*4	7	2	-
2 X 2	other than 16	0	15*3	3	2	2
2 X 2	other than 16	1	15*4	3	2	-
2 Words			15	7	2	2

- Note:**
- \*1 Designates bits 9 to 0 in pattern name data.
  - \*2 Designates bits 11 to 0 in pattern name data.
  - \*3 Designates bits 11 to 2 in pattern name data.
  - \*4 Designates bits 13 to 2 in pattern name data.





- (1) Character Size : 1 H cell X 1 V cell  
 Character Color Count: 16 colors  
 Character Number Supplement Mode: Mode 0

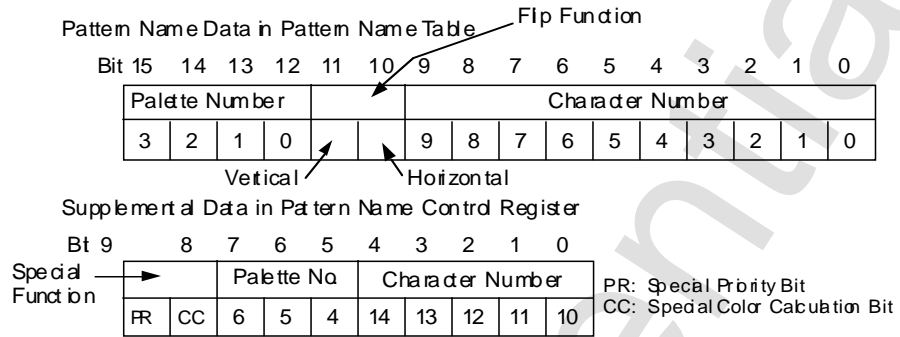

- (2) Character Size : 1 H cell X 1 V cell  
 Character Color Count: 16 colors  
 Character Number Supplement Mode: Mode 1

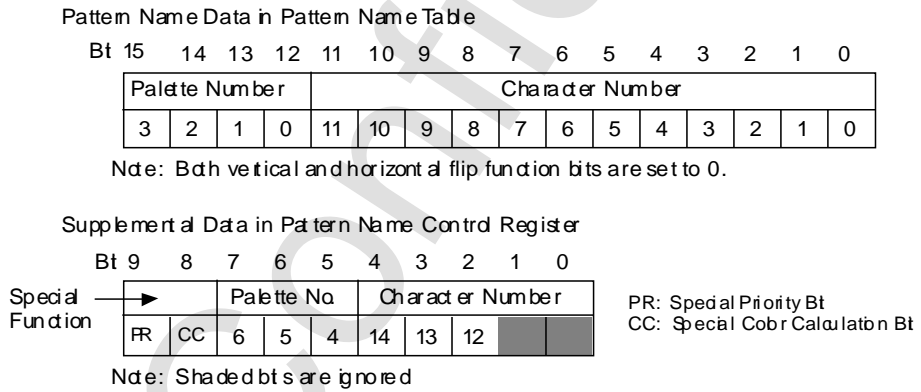

- (3) Character Size : 1 H cell X 1 V cell  
 Character Color Count: 16  
 Character Number Supplement Mode: Mode 0

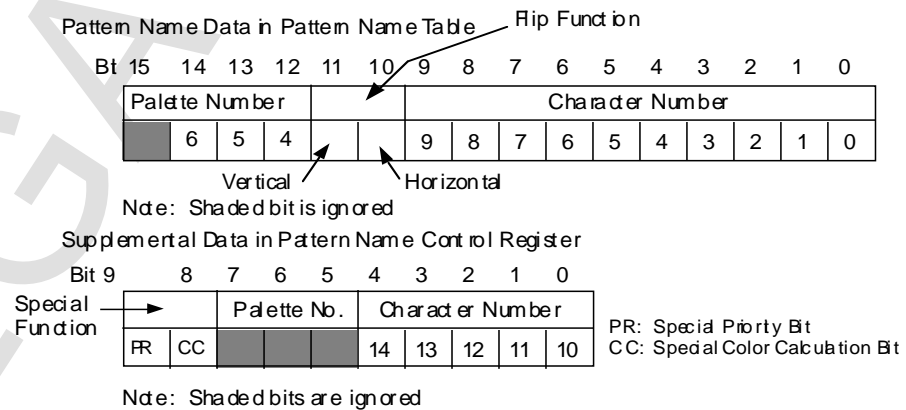

Figure 4.10 Configuration when pattern name data is one word

- (4) Character Size : 1 H cell X 1 V cell  
 Character Color Count : Except 16 colors  
 Character Number Supplement Mode : Mode 1

Pattern Name Data in Pattern Name Table

Bit 15	14	13	12	11	10	9	8	7	6	5	4	3	2	1	0
Palette Number				Character Number											
	6	5	4	11	10	9	8	7	6	5	4	3	2	1	0

Note: Both vertical and horizontal flip function bits are set to 0  
 Shaded bit is ignored

Supplemental Data in Pattern Name Control Register

Bit 9	8	7	6	5	4	3	2	1	0	
Special Function	Palette No.			Character Number						PR: Special Priority Bit
	PR	CC			14	13	12			

Note: Shaded bits are ignored

- (5) Character Size : 2 H cells X 2 V cells  
 Character Color Count : 16 Colors  
 Character Number Supplement Mode : Mode 0

Pattern Name Data in Pattern Name Table

Bit 15	14	13	12	11	10	9	8	7	6	5	4	3	2	1	0
Palette Number				Character Number											
	3	2	1	0		11	10	9	8	7	6	5	4	3	2

Vertical      Horizontal

Supplemental Data in Pattern Name Control Register

Bit 9	8	7	6	5	4	3	2	1	0	
Special Function	Palette No.			Character Number						PR: Special Priority Bit
	PR	CC	6	5	4	14	13	12	1	0

CC: Special Color Calculation Bit

- (6) Character Size : 2 H cells X 2 V cells  
 Character Color Count : 16 Colors  
 Character Number Supplement Mode : Mode 1

Pattern Name Data in Pattern Name Table

Bit 15	14	13	12	11	10	9	8	7	6	5	4	3	2	1	0	
Palette Number				Character Number												
	3	2	1	0	13	12	11	10	9	8	7	6	5	4	3	2

Note: Both vertical and horizontal flip function bits are set to 0.

Supplemental Data in Pattern Name Control Register

Bit 9	8	7	6	5	4	3	2	1	0	
Special Function	Palette No.			Character Number						PR: Special Priority Bit
	PR	CC	6	5	4	14			1	0

Note: Shaded bits are ignored

Figure 4.10 Configuration when pattern name data is one word (continued)



- (7) Character Size : 2 H cells X 2 V cells  
 Character Color Count : Except 16 colors  
 Character Number Supplement Mode : Mode 0

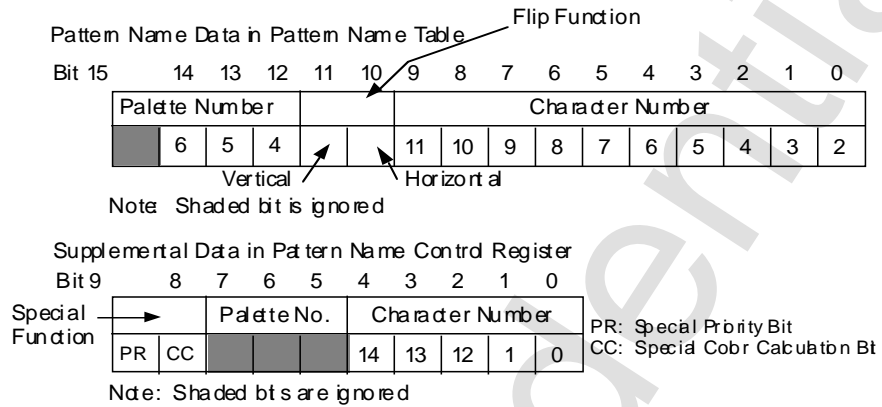

- (8) Character Size : 2 H cells X 2 V cells  
 Character Color Count : Except 16 colors  
 Character Number Supplement Mode : Mode 1

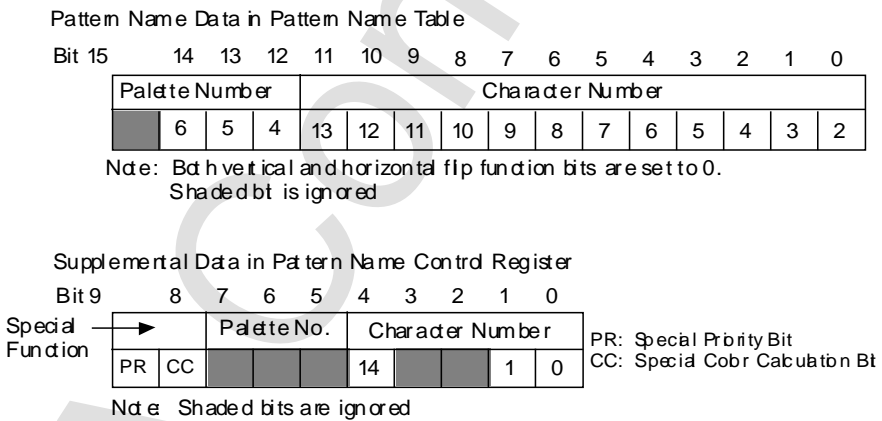

Figure 4.10 Configuration when pattern name data is one word (continued)

## Character Number

The character number is 15-bit data, and designates the address of the character pattern being displayed in that position. The boundary of the character pattern from this character number is always 20H. Moreover, when the VRAM size is 4M bits, the most significant bit of the character number (bit 14) is not used.

## Palette Number

The palette number is 7-bit data, and designates the address of the color palette used in the character pattern being displayed in that position. This data can be used only when the color format is the palette format, not the RGB format. The palette number is added to the dot color code of the character pattern. Because there is a total of 11 bits of dot color data, the bits that are used change depending on the character color number. Figure 4.11 shows the configuration of 11-bit dot color data.

Character Color Count : 16 Colors

Palette Number							Dot Color Code			
6	5	4	3	2	1	0	3	2	1	0

Character Color Count : 256 Colors

Palette No.			Dot Color Code							
6	5	4	7	6	5	4	3	2	1	0

Character Color Count : 2048 Colors

Dot Color Code										
10	9	8	7	6	5	4	3	2	1	0

Figure 4.11 Dot color data by character color number

## Special Function Bit

The special function bit is 2-bit data, and designates whether to use the special function for the character pattern being displayed at that position. The special function bit has a special priority bit that controls the priority number, and a special color calculation bit that controls color operation. See "11.2 Special Priority Function" for more about the special priority bit, and "12.3 Special Color Calculation Function" for more about the special color calculation bit.



## Reverse (Flip) Function Bit

The reverse function bit is 2-bit data, and designates whether to use the reverse function for the character pattern being displayed at that position. The reverse function bit has a top-bottom reverse bit that reverses the top and bottom of a character pattern, and a left-right reverse bit that reverses left and right. The reverse function bit is shown in Table 4.7, and a reverse display of a character pattern is shown in Figure 4.12.

**Table 4.7 Reverse Function Bit**

Vertical Flip Bit	Horizontal Flip Bit	Process
0	0	Cannot flip vertically or horizontally
0	1	Horizontal flipping only
1	0	Vertical flipping only
1	1	Can flip both vertically and horizontally

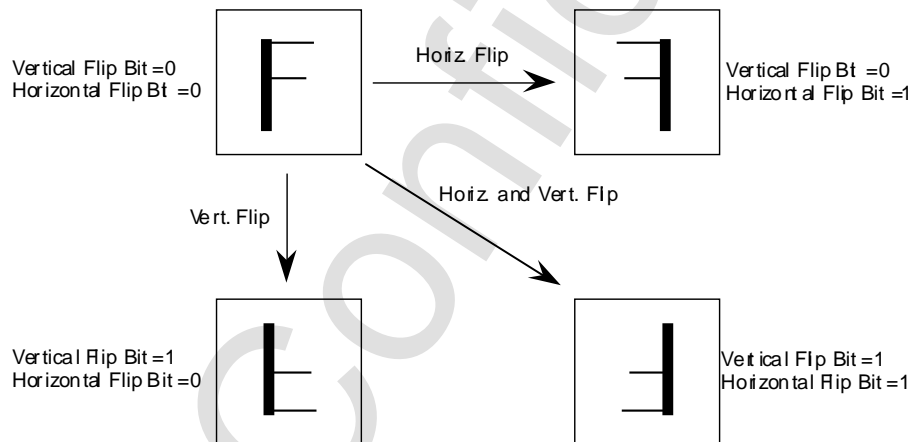

**Figure 4.12 Reverse display of character patterns**

## Pattern Name Control Register

The pattern name control register assigns pattern name data size, character number supplement mode, and pattern name supplement data. This register is a write only 16-bit register located in addresses 180030H to 180038H. Because the value of the register is cleared to 0 after the power is turned on or reset, the value must be set.

	15	14	13	12	11	10	9	8
PNCN0	N0PNB	N0CNSM	~	~	~	~	N0SPR	N0SCC
180030H	7	6	5	4	3	2	1	0
	N0SPLT6	N0SPLT5	N0SPLT4	N0SCN4	N0SCN3	N0SCN2	N0SCN1	N0SCN0
	15	14	13	12	11	10	9	8
PNCN1	N1PNB	N1CNSM	~	~	~	~	N1SPR	N1SCC
180032H	7	6	5	4	3	2	1	0
	N1SPLT6	N1SPLT5	N1SPLT4	N1SCN4	N1SCN3	N1SCN2	N1SCN1	N1SCN0
	15	14	13	12	11	10	9	8
PNCN2	N2PNB	N2CNSM	~	~	~	~	N2SPR	N2SCC
180034H	7	6	5	4	3	2	1	0
	N2SPLT6	N2SPLT5	N2SPLT4	N2SCN4	N2SCN3	N2SCN2	N2SCN1	N2SCN0
	15	14	13	12	11	10	9	8
PNCN3	N3PNB	N3CNSM	~	~	~	~	N3SPR	N3SCC
180036H	7	6	5	4	3	2	1	0
	N3SPLT6	N3SPLT5	N3SPLT4	N3SCN4	N3SCN3	N3SCN2	N3SCN1	N3SCN0
	15	14	13	12	11	10	9	8
PNCR	R0PNB	R0CNSM	~	~	~	~	R0SPR	R0SCC
180038H	7	6	5	4	3	2	1	0
	R0SPLT6	R0SPLT5	R0SPLT4	R0SCN4	R0SCN3	R0SCN2	R0SCN1	R0SCN0

### Pattern name data size bit (N0PNB, N1PNB, N2PNB, N3PNB, R0PNB)

Designates the pattern name data size when displaying in the cell format.

N0PNB	180030H	Bit 15	For NBG0 (or RBG 1)
N1PNB	180032H	Bit 15	For NBG1
N2PNB	180034H	Bit 15	For NBG2
N3PNB	180036H	Bit 15	For NBG3
R0PNB	180038H	Bit 15	For RBG0



xxPNB	Pattern Name Data Size
0	2 Words
1	1 Word

**Note:** N0, N1, N3, or R0 is entered in bit name for xx.

**Character number supplement bit (N0CNSM, N1CNSM, N2CNSM, N3CNSM, R0CNSM)**

Designates the character number supplement mode when the pattern name data size in the pattern name table is 1-word.

N0CNSM	180030H	Bit 14	For NBG0 (or RBG 1)
N1CNSM	180032H	Bit 14	For NBG1
N2CNSM	180034H	Bit 14	For NBG2
N3CNSM	180036H	Bit 14	For NBG3
R0CNSM	180038H	Bit 14	For RBG0

xxCNSM	Character Number Auxiliary Mode	Process
0	0	Character number in pattern name data is 10 bits. Flip function can be selected in character units.
1	1	Character number in pattern name data is 12 bits. Flip function cannot be used.

**Note:** N0, N1, N2, N3, or R0 is entered in bit name for xx.

**Special priority bit (for pattern name supplement data): Supplementary special priority bit (N0SPR, N1SPR, N2SPR, N3SPR, R0SPR)**

Designates the pattern name supplement data as the special priority bit when the pattern name data size is 1-word.

N0SPR	180030H	Bit 9	For NBG0 (or RBG 1)
N1SPR	180032H	Bit 9	For NBG1
N2SPR	180034H	Bit 9	For NBG2
N3SPR	180036H	Bit 9	For NBG3
R0SPR	180038H	Bit 9	For RBG0

See "11.2 Special Color Priority Function" for how this bit is used.

**Special color calculation bit (for pattern name supplement data): Supplementary special color calculation bit (N0SCC, N1SCC, N2SCC, N3SCC, R0SCC)**

The special color calculation bit is designated as pattern name supplement data when the pattern name data size is 1-word.

N0SCC	180030H	Bit 8	For NBG0 (or RBG 1)
N1SCC	180032H	Bit 8	For NBG1
N2SCC	180034H	Bit 8	For NBG2
N3SCC	180036H	Bit 8	For NBG3
R0SCC	180038H	Bit 8	For RBG0

See “12.2 Special Color Calculation Function” to learn how this bit is used.

**Supplementary palette number bit (N0SPLT6 to N0SPLT4, N1SPLT6 to N1SPLT4, N2SPLT6 to N2SPLT4, N3SPLT6 to N3SPLT4, R0SPLT6 to R0SPLT4)**

Designates the palette number bit as pattern name supplement data when the pattern name data size is 1-word. Three bits are added to the palette number bit of the pattern name data for the supplementary palette number bit.

N0SPLT6~N0SPLT4	180030H	Bit 7~5	For NBG0 (or RBG 1)
N1SPLT6~N1SPLT4	180032H	Bit 7~5	For NBG1
N2SPLT6~N2SPLT4	180034H	Bit 7~5	For NBG2
N3SPLT6~N3SPLT4	180036H	Bit 7~5	For NBG3
R0SPLT6~R0SPLT4	180038H	Bit 7~5	For RBG0

**Supplementary character number bit (N0SCN4 to N0SCN0, N1SCN4 to N1SCN0, N2SCN4 to N2SCN0, N3SCN4 to N3SCN0, R0SCN4 to R0SCN0)**

Designates the character number bit as the pattern name supplement data when the pattern name data size is 1-word. Five bits are added to the palette number bit of the pattern name data for the supplementary palette number bit.

N0SCN4~N0SCN0	180030H	Bit 4~0	For NBG0 (or RBG 1)
N1SCN4~N1SCN0	180032H	Bit 4~0	For NBG1
N2SCN4~N2SCN0	180034H	Bit 4~0	For NBG2
N3SCN4~N3SCN0	180036H	Bit 4~0	For NBG3
R0SCN4~R0SCN0	180038H	Bit 4~0	For RBG0





## 4.7 Planes

Plane arranges the pattern name table (page) in sizes of 1 x 1, 2 x 1, or 2 x 2. Size is designated in its respective register.

### Plane Size

When the plane consists of more than one pattern name table (page), the pattern name table used by one plane should be linked to VRAM and stored. Figure 4.13 shows the relationship of the pattern name table arranged by plane size (number of plane page) and pattern name table.

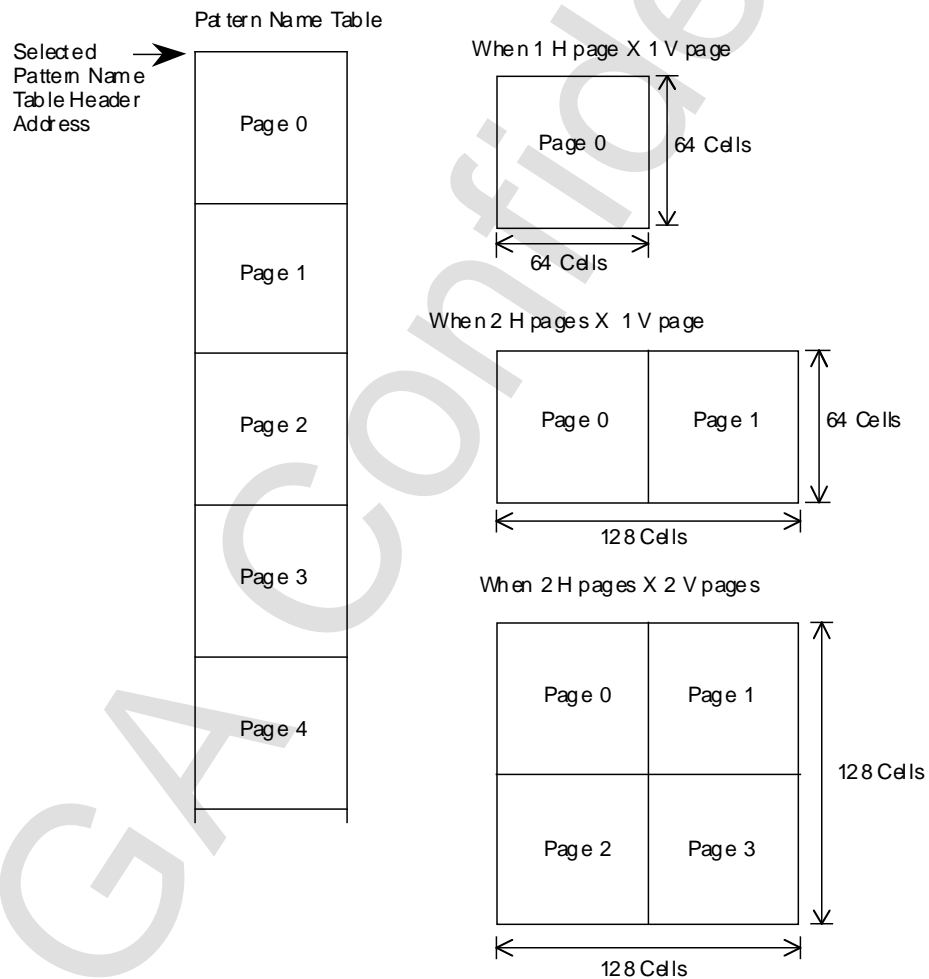

Figure 4.13 Arrangement of pattern name table by plane size

## Plane Size Register

The plane size register controls the plane size and setting of the screen-over process of the rotation scroll surface. This register is a write only 16-bit register located at address 18003AH. Because the value of the register is cleared to 0 after the power is turned on or reset, the value must be set.

	15	14	13	12	11	10	9	8
PLSZ	RBOVR1	RBOVR0	RBPLSZ1	RBPLSZ0	RAOVR1	RAOVR0	RAPLSZ1	RAPLSZ0
18003AH	7	6	5	4	3	2	1	0
	N3PLSZ1	N3PLSZ0	N2PLSZ1	N2PLSZ0	N1PLSZ1	N1PLSZ0	N0PLSZ1	N0PLSZ0

### Plane size bit (N0PLSZ1, N0PLSZ0, N1PLSZ1, N1PLSZ0, N2PLSZ1, N2PLSZ0, N3PLSZ1, N3PLSZ0, RAPLSZ1, RAPLSZ0, RBPLSZ1, RBPLSZ0)

Designates the plane size (number of pages) of each scroll screen.

N0PLSZ1, N0PLSZ0	18003AH	Bit 1,0	For NBG0
N1PLSZ1, N1PLSZ0	18003AH	Bit 3,2	For NBG1
N2PLSZ1, N2PLSZ0	18003AH	Bit 5,4	For NBG2
N3PLSZ1, N3PLSZ0	18003AH	Bit 7,6	For NBG3
RAPLSZ1, RAPLSZ0	18003AH	Bit 9,8	For Rotation Parameter A
RBPLSZ1, RBPLSZ0	18003AH	Bit 13,12	For Rotation Parameter B

xxPLSZ1	xxPLSZ0	Plane Size
0	0	1 H Page X 1 V Page
0	1	2 H Pages X 1 V Page
1	0	Invalid (Do not set.)
1	1	2 H Pages X 2 V Pages

**Note:** N0, N1, N2, N3, RA, or RB is entered in bit name for xx.

When the reduction display is set up to a factor of 1/4 in NBG0 and NBG1, do not set the plane size of that screen to 2 H pages x 2 V pages.



**Screen-over process bit: Over bit (RAOVR1, RAOVR0, RBOVR1, RBOVR0)**

Designates control (screen-over process) when the display coordinate value exceeds the display area in the rotation scroll surface.

RAOVR1, RAOVR0	18003AH	Bit 11,10	For Rotation Parameter A
RBOVR1, RBOVR0	18003AH	Bit 15,14	For Rotation Parameter B

RxOVR1	RxOVR0	Screen Over Process
0	0	Outside the display area, the image set in the display area is repeated.
0	1	Outside the display area, the character pattern specified by screen over pattern name register is repeated. (Only when the rotation scroll surface is in cell format.)
1	0	Outside the display area, the scroll screen is transparent,
1	1	Set the display area as $0 \leq X \leq 512$ , $0 \leq Y \leq 512$ regardless of plane size or bitmap size and make that area transparent.

**Note:** A or B is entered in bit name for x.

When the rotation scroll surface is in bit map, the character pattern designated by the screen-over pattern name register must not be set to repeat process. With the rotation scroll surface in bit map, and when the length of the bit map is 256 dots, if the display area is set to  $0 \leq X < 512$  and  $0 \leq Y < 512$  and all the outer area is set to be transparent, two of the same images will be displayed for each 256 V dots.

## 4.8 Maps

Maps are square patterns consisting of  $2 \times 2$  or  $4 \times 4$  planes. A map of a Normal scroll screen consists of a  $2 \times 2$  plane, and a map of a rotation scroll surface consists of a  $4 \times 4$  plane. The method of arranging the plane is made by selecting the pattern name table lead address in various plane registers.

### Map Selection Register

Maps are organized into four planes (normal scroll screen) or 16 planes (rotation scroll surface). Each screen has for each plane number a 6-bit map register to select the pattern name table lead address for various planes. It also has a map offset register of three bits added to the highest map register. The total 9-bit map selection register changes the bit used and the register displaying the address value, depending on the pattern name data size and character size. Figure 4.14 shows the relationship of the map register and map offset register.

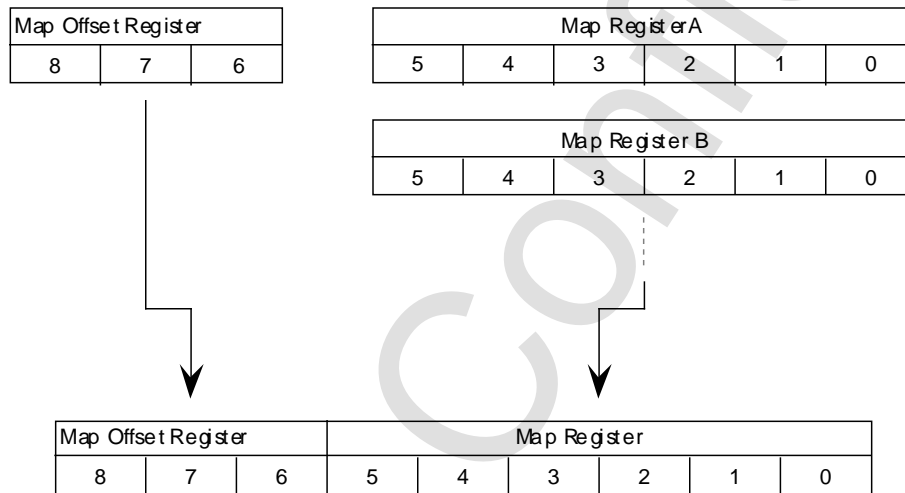

**Figure 4.14** Map selection register

Table 4.8 shows the address values of register and bits that are used for the map selection register by the pattern name data size and character size.



**Table 4.8 Address value of map designated register by setting**

Plane Size	Pattern Name Data Size	Character Size	Bits and Addresses
1 H page X 1 V page	1 Word	1 H Cell X 1 V Cell	(Value of bit 6~0) X 2000H
		2 H Cells X 2 V Cells	(Value of bit 8~0) X 800H
	2 Words	1 H Cell X 1 V Cell	(Value of bit 5~0) X 4000H
		2 H Cells X 2 V Cells	(Value of bit 7~0) X 1000H
2 H pages X 1 V page	1 Word	1 H Cell X 1 V Cell	(Value of bit 6~1) X 4000H
		2 H Cells X 2 V Cells	(Value of bit 8~1) X 1000H
	2 Words	1 H Cell X 1 V Cell	(Value of bit 5~1) X 8000H
		2 H Cells X 2 V Cells	(Value of bit 7~1) X 2000H
2 H pages X 2 V pages	1 Word	1 H Cell X 1 V Cell	(Value of bit 6~2) X 8000H
		2 V Cells X 2 V Cells	(Value of bit 8~2) X 2000H
	2 Words	1 H Cell X 1 V Cell	(Value of bit 5~2) X 10000H
		2 H Cells X 2 V Cells	(Value of bit 7~2) X 4000H

**Note:** When the VRAM capacity is set at 4M bits, the most significant bit among the bits used is not used.

## Map Size

Map size (number of planes in the map) will change depending on if the screen is a normal scroll screen or rotation scroll surface. The normal scroll screen has a map 2 H planes X 2 V planes in each screen. The rotation scroll surface has a map 4 H planes X 4 V planes in both of rotation parameters A and B. Figure 4.15 shows the plane arrangements of different map sizes.

Normal Scroll Screen

Plane A	Plane B
Plane C	Plane D

Rotation Scroll Screen

Plane A	Plane B	Plane C	Plane D
Plane E	Plane F	Plane G	Plane H
Plane I	Plane J	Plane K	Plane L
Plane M	Plane N	Plane O	Plane P

Figure 4.15 Map size



When NBG0 and NBG1 enable bits (N0ZMQT and N1ZMQT) are set to allow reduction up to a factor of 1/4, the map size of NBG0 and NBG1 become normal. A set screen plane size, that can be reduced up to 1/4 should not be 2 H pages X 2 V pages. Figure 4.16 shows the map size by the reduction setting.

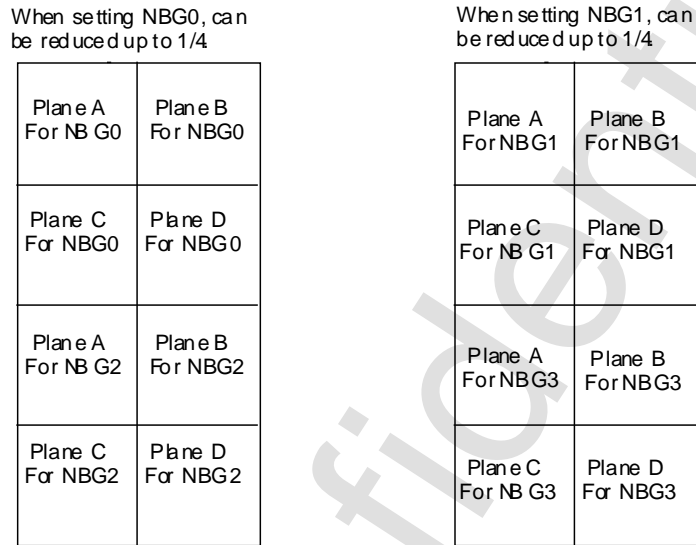

Figure 4.16 Plane arrangement of map by reduction settings

### Map Offset Register

The map offset register designates the map offset value. This is a write-only 16-bit register, with addresses located at 18003CH to 18003EH. Because the value of the register is cleared to 0 after the power is turned on or reset, the value must be set.

	15	14	13	12	11	10	9	8
MPOFN	~	N3MP8	N3MP7	N3MP6	~	N2MP8	N2MP7	N2MP6
18003CH	7	6	5	4	3	2	1	0
	~	N1MP8	N1MP7	N1MP6	~	N0MP8	N0MP7	N0MP6
	15	14	13	12	11	10	9	8
MPOFR	~	~	~	~	~	~	~	~
18003EH	7	6	5	4	3	2	1	0
	~	RBMP8	RBMP7	RBMP6	~	RAMP8	RAMP7	RAMP6

**Map offset bit (N0MP8 to N0MP6, N1MP8 to N1MP6, N2MP8 to N2MP6, N3MP8 to N3MP6, RAMP8 to RAMP6, RBMP8 to RBMP6)**

When the scroll screen display format is the cell format, the map offset value of 3 bits is added to the highest 6 bits of the map register. This designates the bit map pattern boundary when in the bit map format.

N0MP8~N0MP6	18003CH	Bit 2~0	For NBG0
N1MP8~N1MP6	18003CH	Bit 6~4	For NBG1
N2MP8~N2MP6	18003CH	Bit 10~8	For NBG2
N3MP8~N3MP6	18003CH	Bit 14~12	For NBG3
RAMP8~RAMP6	18003EH	Bit 2~0	For Rotation Parameter A
RBMP8~RBMP6	18003EH	Bit 6~4	For Rotation Parameter B

Boundary address of the bit map pattern is shown below:

(boundary address value of the bit map pattern) = (map offset register value 3 bit) x 20000H.





## Normal Scroll Screen Map Register

Normal scroll screen map register designates the lead address of the pattern name table of each plane when the normal scroll screen is displayed in the cell format. This register is a write-only 16-bit register, with addresses located at 180040H to 18004EH. Because the value of the register is cleared to 0 after the power is turned on or reset, the value must be set.

	15	14	13	12	11	10	9	8
MPABN0	~	~	N0MPB5	N0MPB4	N0MPB3	N0MPB2	N0MPB1	N0MPB0
180040H	7	6	5	4	3	2	1	0
	~	~	N0MPA5	N0MPA4	N0MPA3	N0MPA2	N0MPA1	N0MPA0
	15	14	13	12	11	10	9	8
MPCDN0	~	~	N0MPD5	N0MPD4	N0MPD3	N0MPD2	N0MPD1	N0MPD0
180042H	7	6	5	4	3	2	1	0
	~	~	N0MPC5	N0MPC4	N0MPC3	N0MPC2	N0MPC1	N0MPC0
	15	14	13	12	11	10	9	8
MPABN1	~	~	N1MPB5	N1MPB4	N1MPB3	N1MPB2	N1MPB1	N1MPB0
180044H	7	6	5	4	3	2	1	0
	~	~	N1MPA5	N1MPA4	N1MPA3	N1MPA2	N1MPA1	N1MPA0
	15	14	13	12	11	10	9	8
MPCDN1	~	~	N1MPD5	N1MPD4	N1MPD3	N1MPD2	N1MPD1	N1MPD0
180046H	7	6	5	4	3	2	1	0
	~	~	N1MPC5	N1MPC4	N1MPC3	N1MPC2	N1MPC1	N1MPC0
	15	14	13	12	11	10	9	8
MPABN2	~	~	N2MPB5	N2MPB4	N2MPB3	N2MPB2	N2MPB1	N2MPB0
180048H	7	6	5	4	3	2	1	0
	~	~	N2MPA5	N2MPA4	N2MPA3	N2MPA2	N2MPA1	N2MPA0
	15	14	13	12	11	10	9	8
MPCDN2	~	~	N2MPD5	N2MPD4	N2MPD3	N2MPD2	N2MPD1	N2MPD0
18004AH	7	6	5	4	3	2	1	0
	~	~	N2MPC5	N2MPC4	N2MPC3	N2MPC2	N2MPC1	N2MPC0
	15	14	13	12	11	10	9	8
MPABN3	~	~	N3MPB5	N3MPB4	N3MPB3	N3MPB2	N3MPB1	N3MPB0
18004CH	7	6	5	4	3	2	1	0
	~	~	N3MPA5	N3MPA4	N3MPA3	N3MPA2	N3MPA1	N3MPA0
	15	14	13	12	11	10	9	8
MPCDN3	~	~	N3MPD5	N3MPD4	N3MPD3	N3MPD2	N3MPD1	N3MPD0
18004EH	7	6	5	4	3	2	1	0
	~	~	N3MPC5	N3MPC4	N3MPC3	N3MPC2	N3MPC1	N3MPC0

Map bit (for normal scroll): (N0MPA5 to N0MPA0, N0MPB5 to N0MPB0, N0MPC5 to N0MPC0, N0MPD5 to N0MPD0, N1MPA5 to N1MPA0, N1MPB5 to N1MPB0, N1MPC5 to N1MPC0, N1MPD5 to N1MPD0, N2MPA5 to N2MPA0, N2MPB5 to N2MPB0, N2MPC5 to N2MPC0, N2MPD5 to N2MPD0, N3MPA5 to N3MPA0, N3MPB5 to N3MPB0, N3MPC5 to N3MPC0, N3MPD5 to N3MPD0)

The lead address for the pattern name table is designated for each plane, when the Normal scroll screen is displayed by the cell format.

N0MPA5~N0MPA0	180040H	Bit 5~0	For NBG0 Plane A
N0MPB5~N0MPB0	180040H	Bit 13~8	For NBG0 Plane B
N0MPC5~N0MPC0	180042H	Bit 5~0	For NBG0 Plane C
N0MPD5~N0MPD0	180042H	Bit 13~8	For NBG0 Plane D
N1MPA5~N1MPA0	180044H	Bit 5~0	For NBG1 Plane A
N1MPB5~N1MPB0	180044H	Bit 13~8	For NBG1 Plane B
N1MPC5~N1MPC0	180046H	Bit 5~0	For NBG1 Plane C
N1MPD5~N1MPD0	180046H	Bit 13~8	For NBG1 Plane D
N2MPA5~N2MPA0	180048H	Bit 5~0	For NBG2 Plane A
N2MPB5~N2MPB0	180048H	Bit 13~8	For NBG2 Plane B
N2MPC5~N2MPC0	18004AH	Bit 5~0	For NBG2 Plane C
N2MPD5~N2MPD0	18004AH	Bit 13~8	For NBG2 Plane D
N3MPA5~N3MPA0	18004CH	Bit 5~0	For NBG3 Plane A
N3MPB5~N3MPB0	18004CH	Bit 13~8	For NBG3 Plane B
N3MPC5~N3MPC0	18004EH	Bit 5~0	For NBG3 Plane C
N3MPD5~N3MPD0	18004EH	Bit 13~8	For NBG3 Plane D



## Rotation Scroll Surface Map Register

The Rotation Scroll Surface Map Register designates the lead address of the pattern name table arranged in each plane by rotation parameters A and B. When a write-only 16-bit register, with addresses located at 180050H to 18006EH. Because the value of the register is cleared to 0 after the power is turned on or reset, the value must be set.

	15	14	13	12	11	10	9	8
MPABRA	~	~	RAMPB5	RAMPB4	RAMPB3	RAMPB2	RAMPB1	RAMPB0
180050H	7	6	5	4	3	2	1	0
	~	~	RAMPA5	RAMPA4	RAMPA3	RAMPA2	RAMPA1	RAMPA0
	15	14	13	12	11	10	9	8
MPCDRA	~	~	RAMPD5	RAMPD4	RAMPD3	RAMPD2	RAMPD1	RAMPD0
180052H	7	6	5	4	3	2	1	0
	~	~	RAMPC5	RAMPC4	RAMPC3	RAMPC2	RAMPC1	RAMPC0
	15	14	13	12	11	10	9	8
MPEFRA	~	~	RAMPF5	RAMPF4	RAMPF3	RAMPF2	RAMPF1	RAMPF0
180054H	7	6	5	4	3	2	1	0
	~	~	RAMPE5	RAMPE4	RAMPE3	RAMPE2	RAMPE1	RAMPE0
	15	14	13	12	11	10	9	8
MPGHRA	~	~	RAMPH5	RAMPH4	RAMPH3	RAMPH2	RAMPH1	RAMPH0
180056H	7	6	5	4	3	2	1	0
	~	~	RAMPG5	RAMPG4	RAMPG3	RAMPG2	RAMPG1	RAMPG0
	15	14	13	12	11	10	9	8
MPIJRA	~	~	RAMPJ5	RAMPJ4	RAMPJ3	RAMPJ2	RAMPJ1	RAMPJ0
180058H	7	6	5	4	3	2	1	0
	~	~	RAMPI5	RAMPI4	RAMPI3	RAMPI2	RAMPI1	RAMPI0
	15	14	13	12	11	10	9	8
MPKLRA	~	~	RAMPL5	RAMPL4	RAMPL3	RAMPL2	RAMPL1	RAMPL0
18005AH	7	6	5	4	3	2	1	0
	~	~	RAMPK5	RAMPK4	RAMPK3	RAMPK2	RAMPK1	RAMPK0
	15	14	13	12	11	10	9	8
MPMNRA	~	~	RAMPN5	RAMPN4	RAMPN3	RAMPN2	RAMPN1	RAMPN0
18005CH	7	6	5	4	3	2	1	0
	~	~	RAMPM5	RAMPM4	RAMPM3	RAMPM2	RAMPM1	RAMPM0
	15	14	13	12	11	10	9	8
MPOPRA	~	~	RAMPP5	RAMPP4	RAMPP3	RAMPP2	RAMPP1	RAMPP0
18005EH	7	6	5	4	3	2	1	0
	~	~	RAMPO5	RAMPO4	RAMPO3	RAMPO2	RAMPO1	RAMPO0

	15	14	13	12	11	10	9	8
MPABRB	~	~	RBMPB5	RBMPB4	RBMPB3	RBMPB2	RBMPB1	RBMPB0
180060H	7	6	5	4	3	2	1	0
	~	~	RBMPA5	RBMPA4	RBMPA3	RBMPA2	RBMPA1	RBMPA0

	15	14	13	12	11	10	9	8
MPCDRB	~	~	RBMPD5	RBMPD4	RBMPD3	RBMPD2	RBMPD1	RBMPD0
180062H	7	6	5	4	3	2	1	0
	~	~	RBMPC5	RBMPC4	RBMPC3	RBMPC2	RBMPC1	RBMPC0

	15	14	13	12	11	10	9	8
MPEFRB	~	~	RBMPF5	RBMPF4	RBMPF3	RBMPF2	RBMPF1	RBMPF0
180064H	7	6	5	4	3	2	1	0
	~	~	RBMPE5	RBMPE4	RBMPE3	RBMPE2	RBMPE1	RBMPE0

	15	14	13	12	11	10	9	8
MPGHRB	~	~	RBMPH5	RBMPH4	RBMPH3	RBMPH2	RBMPH1	RBMPH0
180066H	7	6	5	4	3	2	1	0
	~	~	RBMPG5	RBMPG4	RBMPG3	RBMPG2	RBMPG1	RBMPG0

	15	14	13	12	11	10	9	8
MPIJRB	~	~	RBMPJ5	RBMPJ4	RBMPJ3	RBMPJ2	RBMPJ1	RBMPJ0
180068H	7	6	5	4	3	2	1	0
	~	~	RBMPI5	RBMPI4	RBMPI3	RBMPI2	RBMPI1	RBMPI0

	15	14	13	12	11	10	9	8
MPKLRB	~	~	RBMPL5	RBMPL4	RBMPL3	RBMPL2	RBMPL1	RBMPL0
18006AH	7	6	5	4	3	2	1	0
	~	~	RBMPK5	RBMPK4	RBMPK3	RBMPK2	RBMPK1	RBMPK0

	15	14	13	12	11	10	9	8
MPMNRB	~	~	RBMPN5	RBMPN4	RBMPN3	RBMPN2	RBMPN1	RBMPN0
18006CH	7	6	5	4	3	2	1	0
	~	~	RBMPM5	RBMPM4	RBMPM3	RBMPM2	RBMPM1	RBMPM0

	15	14	13	12	11	10	9	8
MPOPRB	~	~	RBMP5	RBMP4	RBMP3	RBMP2	RBMP1	RBMP0
18006EH	7	6	5	4	3	2	1	0
	~	~	RBMPO5	RBMPO4	RBMPO3	RBMPO2	RBMPO1	RBMPO0



Map bit (for rotation scroll): Map bit (RAMPA5 to RAMPA0, RAMPB5 to RAMPB0, RAMPC5 to RAMPC0, RAMPD5 to RAMPD0, RAMPE5 to RAMPE0, RAMPF5 to RAMPF0, RAMPG5 to RAMPG0, RAMPH5 to RAMPH0, RAMPJ5 to RAMPJ0, RAMPK5 to RAMPK0, RAMPL5 to RAMPL0, RAMPM5 to RAMPM0, RAMPN5 to RAMPN0, RAMPO5 to RAMPO0, RAMP5 to RAMP0, RBMPA5 to RBMPA0, RBMPB5 to RBMPB0, RBMPC5 to RBMPC0, RBMPD5 to RBMPD0, RBMPE5 to RBMPE0, RBMPF5 to RBMPF0, RBMPG5 to RBMPG0, RBMPH5 to RBMPH0, RBMPI5 to RBMPI0, RBMPJ5 to RBMPJ0, RBMPK5 to RBMPK0, RBMPL5 to RBMPL0, RBMPM5 to RBMPM0, RBMPN5 to RBMPN0, RBMPO5 to RBMPO0, RBMPP5 to RBMPP0)

When a rotation scroll surface is displayed in the cell format, it designates the lead address of the pattern name table being arranged in each plane .

SEGA Confidential

RAMPA5~RAMPA0	180050H	Bit 5~0	Rotation Parameter A for Screen Plane A
RAMPB5~RAMPB0	180050H	Bit 13~8	Rotation Parameter A for Screen Plane B
RAMPC5~RAMPC0	180052H	Bit 5~0	Rotation Parameter A for Screen Plane C
RAMPD5~RAMPD0	180052H	Bit 13~8	Rotation Parameter A for Screen Plane D
RAMPE5~RAMPE0	180054H	Bit 5~0	Rotation Parameter A for Screen Plane E
RAMPF5~RAMPF0	180054H	Bit 13~8	Rotation Parameter A for Screen Plane F
RAMPG5~RAMPG0	180056H	Bit 5~0	Rotation Parameter A for Screen Plane G
RAMPH5~RAMPH0	180056H	Bit 13~8	Rotation Parameter A for Screen Plane H
RAMPI5~RAMPI0	180058H	Bit 5~0	Rotation Parameter A for Screen Plane I
RAMPJ5~RAMPJ0	180058H	Bit 13~8	Rotation Parameter A for Screen Plane J
RAMPK5~RAMPK0	18005AH	Bit 5~0	Rotation Parameter A for Screen Plane K
RAMPL5~RAMPL0	18005AH	Bit 13~8	Rotation Parameter A for Screen Plane L
RAMPM5~RAMPM0	18005CH	Bit 5~0	Rotation Parameter A for Screen Plane M
RAMPN5~RAMPN0	18005CH	Bit 13~8	Rotation Parameter A for Screen Plane N
RAMPO5~RAMPO0	18005EH	Bit 5~0	Rotation Parameter A for Screen Plane O
RAMP5~RAMPP0	18005EH	Bit 13~8	Rotation Parameter A for Screen Plane P
RBMPA5~RBMPA0	180060H	Bit 5~0	Rotation Parameter B for Screen Plane A
RBMPB5~RBMPB0	180060H	Bit 13~8	Rotation Parameter B for Screen Plane B
RBMPC5~RBMPC0	180062H	Bit 5~0	Rotation Parameter B for Screen Plane C
RBMPD5~RBMPD0	180062H	Bit 13~8	Rotation Parameter B for Screen Plane D
RBMPE5~RBMPE0	180064H	Bit 5~0	Rotation Parameter B for Screen Plane E
RBMPF5~RBMPF0	180064H	Bit 13~8	Rotation Parameter B for Screen Plane F
RBMPG5~RBMPG0	180066H	Bit 5~0	Rotation Parameter B for Screen Plane G
RBMPH5~RBMPH0	180066H	Bit 13~8	Rotation Parameter B for Screen Plane H
RBMPI5~RBMPI0	180068H	Bit 5~0	Rotation Parameter B for Screen Plane I
RBMPJ5~RBMPJ0	180068H	Bit 13~8	Rotation Parameter B for Screen Plane J
RBMPK5~RBMPK0	18006AH	Bit 5~0	Rotation Parameter B for Screen Plane K
RBMPL5~RBMPL0	18006AH	Bit 13~8	Rotation Parameter B for Screen Plane L
RBMPM5~RBMPM0	18006CH	Bit 5~0	Rotation Parameter B for Screen Plane M
RBMPN5~RBMPN0	18006CH	Bit 13~8	Rotation Parameter B for Screen Plane N
RBMPO5~RBMPO0	18006EH	Bit 5~0	Rotation Parameter B for Screen Plane O
RBMP5~RBMPPP0	18006EH	Bit 13~8	Rotation Parameter B for Screen Plane P



## 4.9 Bit Maps

When displaying the bit map format, select from sizes, 512 H dots x 256 V dots, 512 H dots x 512 V dots, 1024 H dots x 256 V dots, or 1024 H dots X 512 V dots. All dot bit map pattern data is stored in the VRAM.

### Bit Map Size

Different types of bit map sizes can be selected by the normal scroll screen and rotation scroll surface. When a high-resolution graphics mode that is greater than 512 H pixels is selected in a Normal scroll screen, if a 512 H dot bit map size is selected, the same picture is repeated in the horizontal direction. Furthermore, when the vertical resolution selects the exclusive monitor mode or double-density interlace mode with more than 256 pixels when a 256 V dot bit map size is selected, the same picture is repeated in the vertical direction. Table 4.9 shows bit map sizes.

**Table 4.9 Bit map size**

Screen	Bitmap Size Selections
Normal Scroll Screen	512 H dots X 256 V dots
	512 H dots X 512 V dots
	1024 H dots X 256 V dots
	1024 H dots X 512 V dots
Rotation Scroll Screen	512 H dots X 256 V dots
	512 H dots X 512 V dots

### Bit Map Color Number

The color format for displaying the bit map format screen combines the bit map palette number and dot color code within bit map pattern data. It has a palette format, which designates the color RAM address, and RGB format that directly designates display RGB data. Table 4.10 shows, in various color formats the bit map surface per color number and the bit number per dot of the bit map pattern data. Furthermore, the bit map color count is set to the character color count bit of the character control register.

**Table 4.10 Bit map color count**

Color Format	Bitmap Color Count	Bitmap Pattern Data Bit Count For 1 Dot
Palette	16 colors	4 bits
	256 colors	8 bits
	2048 colors	16 bits (only use lower 11 bits)
RGB	32,768 colors	16 bits
	16,770,000 colors	32 bits (only use MSB and lower 24 bits)

**Note:** 2028 colors become 1024 colors when the color RAM mode is 0 or 2.

SEGA Confidential





## Bit Map Pattern

The required VRAM capacity in a 1-bit map pattern surface depends upon the bit map size and bit map color count (bit map pattern data size). Changes in the data configuration of each bit map pattern stored in VRAM are identical. The bit map size and bit map color count can be set to exceed the VRAM capacity, but the same picture would be repeated in the vertically. Table 4.11 shows bit map pattern capacities and Figure 4.17 shows the bit map pattern configuration.

The boundary that stores bit map patterns in the VRAM is 20000H, and is independent of the bit map size and the bit map color count. The designation is performed in the map offset register.

**Table 4.11 Bit map pattern capacity per 1 surface**

Bitmap Size	Bitmap Pattern Data Size	Bitmap Color Count	Size per Surface
512 H dots X 256 V dots	4 bits/dot	16 colors	64K bytes (512K bits)
	8 bits/dot	256 colors	128K bytes (1M bits)
	16 bits/dot	2048 colors, 32,768 colors	256K bytes (2M bits)
	32 bits/dot	16,770,000 colors	512K bytes (4M bits)
512 H dots X 512 V dots	4 bits/dot	16 colors	128K bytes (1M bits)
	8 bits/dot	256 colors	256K bytes (2M bits)
	16 bits/dot	2048 colors, 32,768 colors	512K bytes (4M bits)
	32 bits/dot	16,770,000 colors	1024K bytes (8M bits)
1024 H dots X 256 V dots	4 bits/dot	16 colors	128K bytes (1M bits)
	8 bits/dot	256 colors	256K bytes (2M bits)
	16 bits/dot	2048 colors, 32,768 colors	512K bytes (4M bits)
	32 bits/dot	16,770,000 colors	1024K bytes (8M bits)
1024 H dots X 512 V dots	4 bits/dot	16 colors	256K bytes (2M bits)
	8 bits/dot	256 colors	512K bytes (4M bits)
	16 bits/dot	2048 colors, 32,768 colors	1024K bytes (8M bits)

- (1) Bit map Size : 512 H dots X 256 V dots  
 Bit map Color Count : 4 bits/dot (16 colors)

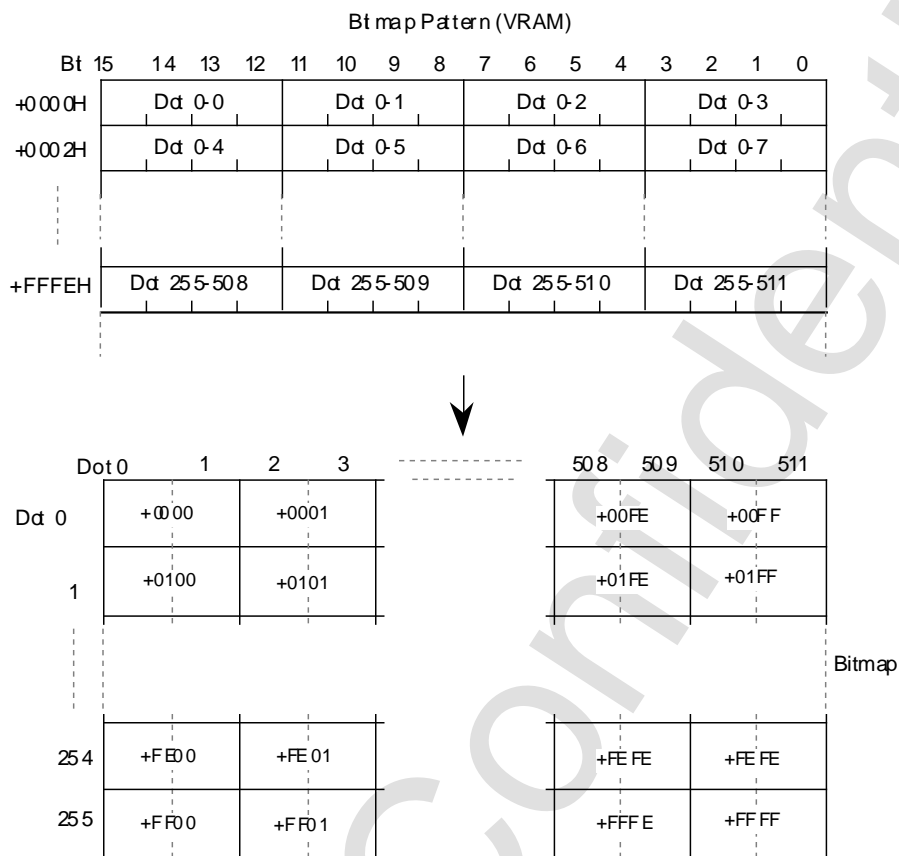

- Note 1: The upper left notation in the cell is dot 0-0; to the right are dot 0-1, dot 0-2, dot 0-3, ...
- Note 2: Numbers in the cells are VRAM addresses (hexadecimal) of dot (2 dots) data with VRAM address of dot 0-0, 0-1 data as the reference.

**Figure 4.17 Bit map pattern configuration**



(2) Bitmap Size : 512 H dots X 256 V dots  
 Bitmap Color Count : 8 bit s/dot (256 colors)

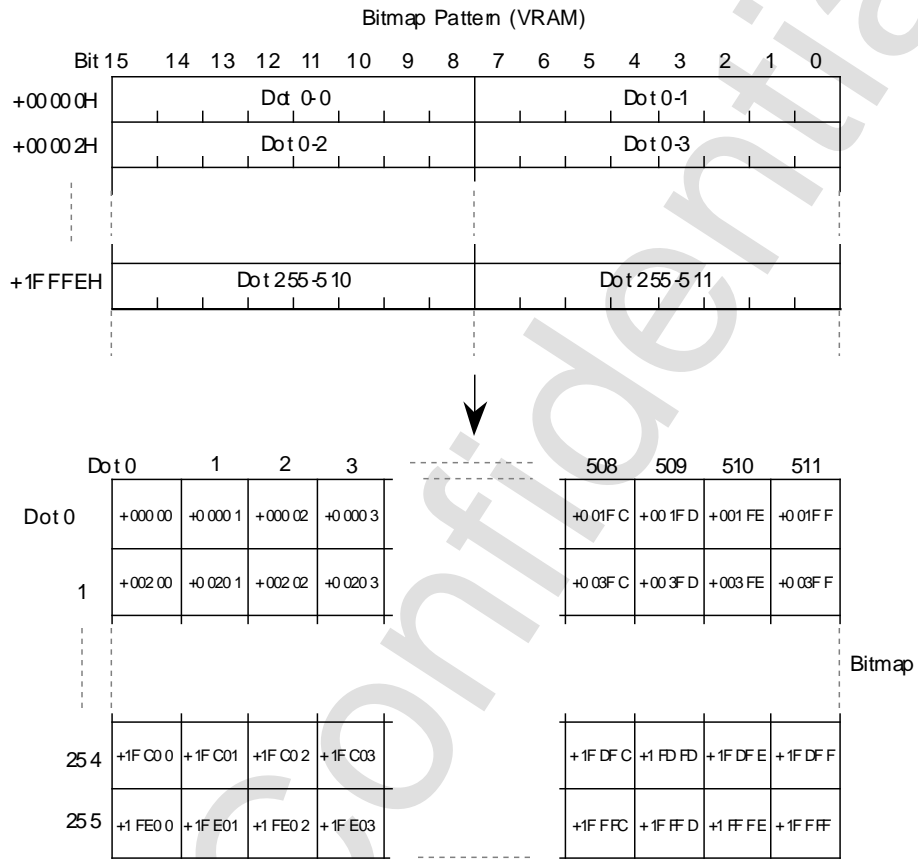

Note 1: The upper left notation in the cell is dot 0-0; to the right are dot 0-1, dot 0-2, dot 0-3, ...

Note 2: Numbers in the cells are VRAM addresses (hexadecimal) of dot data, with VRAM address of dot 0-0 data as the reference.

**Figure 4.17 Bit map pattern configuration (continued)**

- (3) Bit map Size : 512 H dots X 256 V dots  
 Bit map Color Count : 16 bits/dot (2048 colors, 32768 colors)

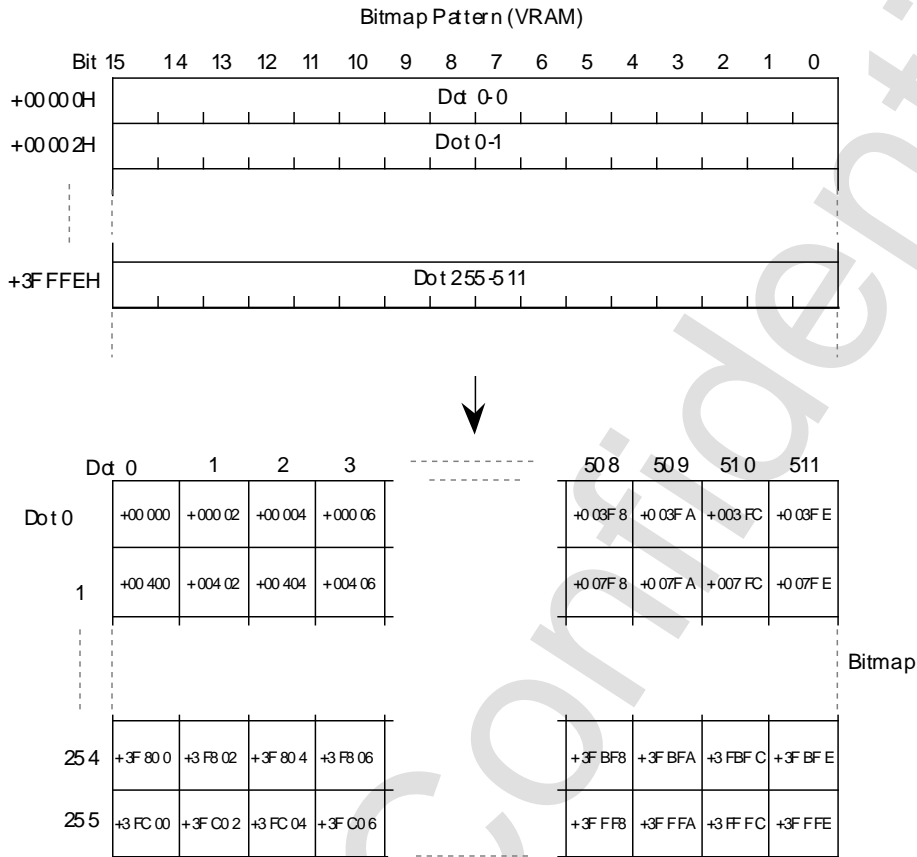

- Note 1: The upper left notation in the cell is dot 0-0, to the right are dot 0-1, dot 0-2, dot 0-3, ...
- Note 2: Numbers in the cells are VRAM addresses (hexadecimal) of dot data, with VRAM address of dot 0-0 data as the reference.

**Figure 4.17 Bit map pattern configuration (continued)**



(4) Bit map Size : 512 H dds X 256 V dds  
 Bit map Color Count : 32 bits/ dot (16,770,000 colors)

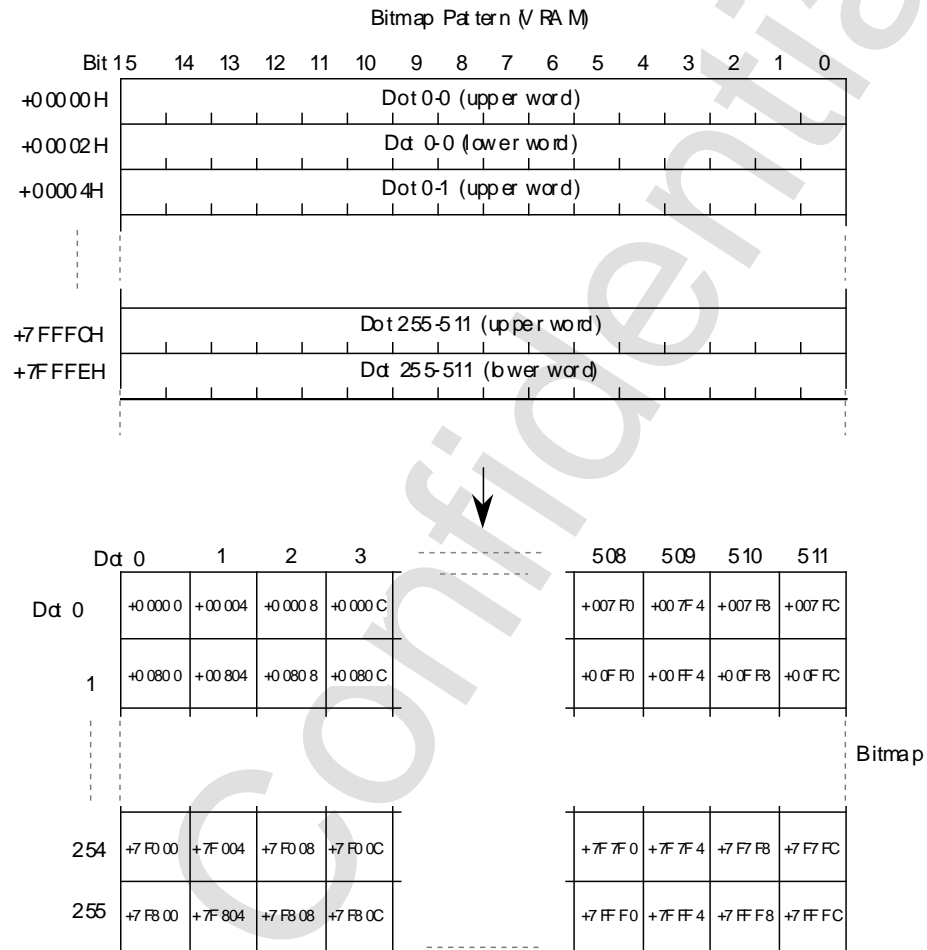

Note 1: The upper left notation in the cell is dot 0-0; to the right are dot 0-1, dot 0-2, dot 0-3, ...

Note 2: Numbers in the cells are VRAM addresses (hexadecimal) of dot data (upper word), with VRAM address of dot 0-0 data (upper word) as the reference.

Figure 4.17 Bit map pattern configuration (continue)

- (5) Bitmap Size : 512 H dots X 512 V dots  
 Bitmap Color Count : 4 bit/dot (16 colors)

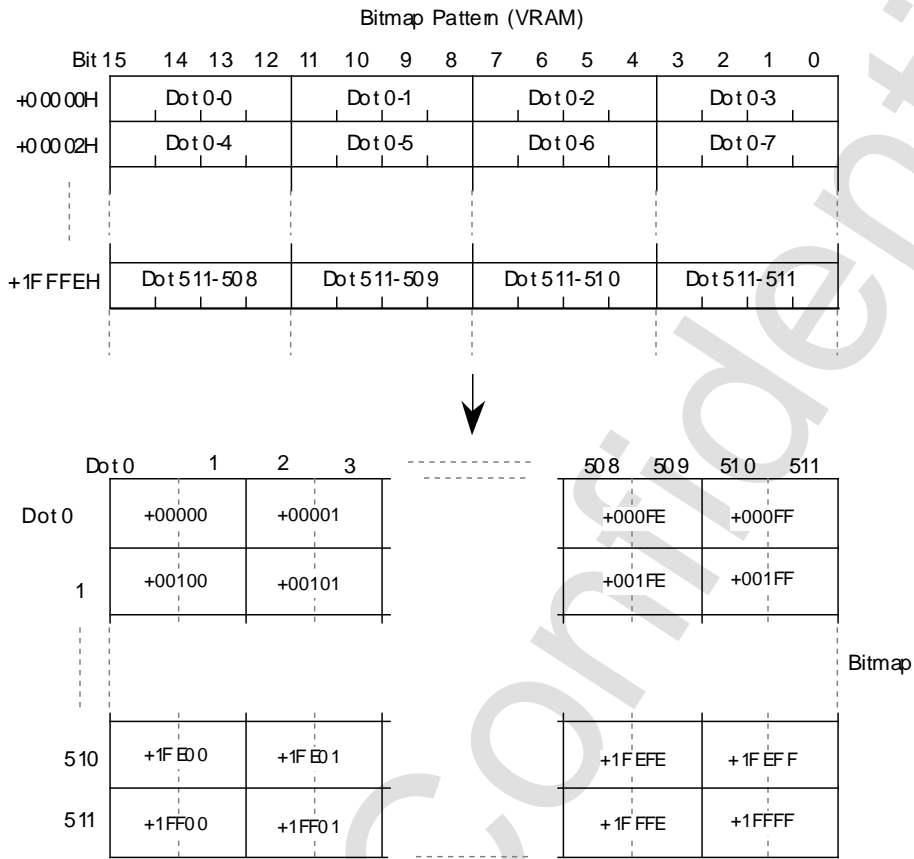

Note 1: The upper left notation in the cell is dot 0-0 to the right are dot 0-1, dot 0-2 dot 0-3 ...

Note 2: Numbers in the cells are VRAM addresses (hexadecimal) of dot (2 dots) data, with VRAM address of dot 0-0, 0-1 data as the reference.

**Figure 4.17 Bit map pattern configuration (continued)**



(6) Bitmap Size : 512 H dots X 512 V dots  
 Bitmap Color Count : 8 bits/dot (256 colors)

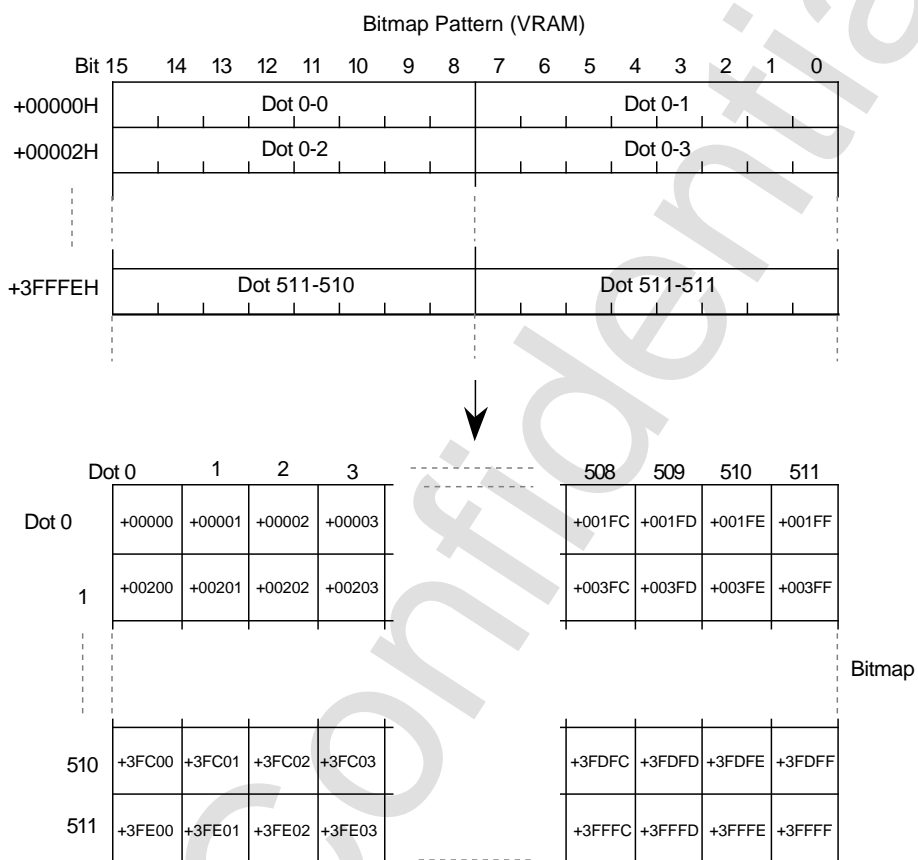

Note 1: The upper left notation in the cell is dot 0-0; to the right are dot 0-1, dot 0-2, dot 0-3, ...

Note 2: Numbers in the cells are VRAM addresses (hexadecimal) of dot data, with VRAM address of dot 0-0 data as the reference.

**Figure 4.17 Bit map pattern configuration (continued)**

- (7) Bitmap Size : 512 H dots X 512 V dots  
 Bitmap Color Count : 16 bits/dot (2048 colors, 32768 colors)

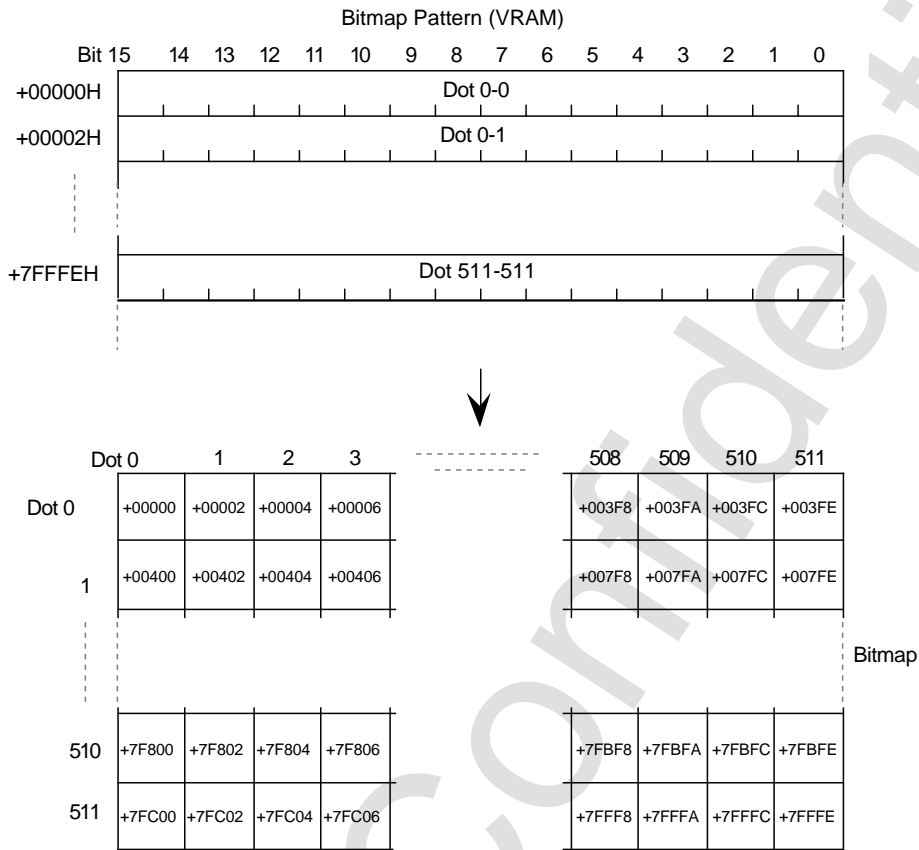

- Note 1: The upper left notation in the cell is dot 0-0; to the right are dot 0-1, dot 0-2, dot 0-3, ...  
 Note 2: Numbers in the cells are VRAM addresses (hexadecimal) of dot data, with VRAM address of dot 0-0 data as the reference.

**Figure 4.17 Bit map pattern configuration (continued)**





(8) Bitmap Size : 512 H dots X 512 V dots  
 Bitmap Color Count : 32 bits/dot (16,770,000 colors)

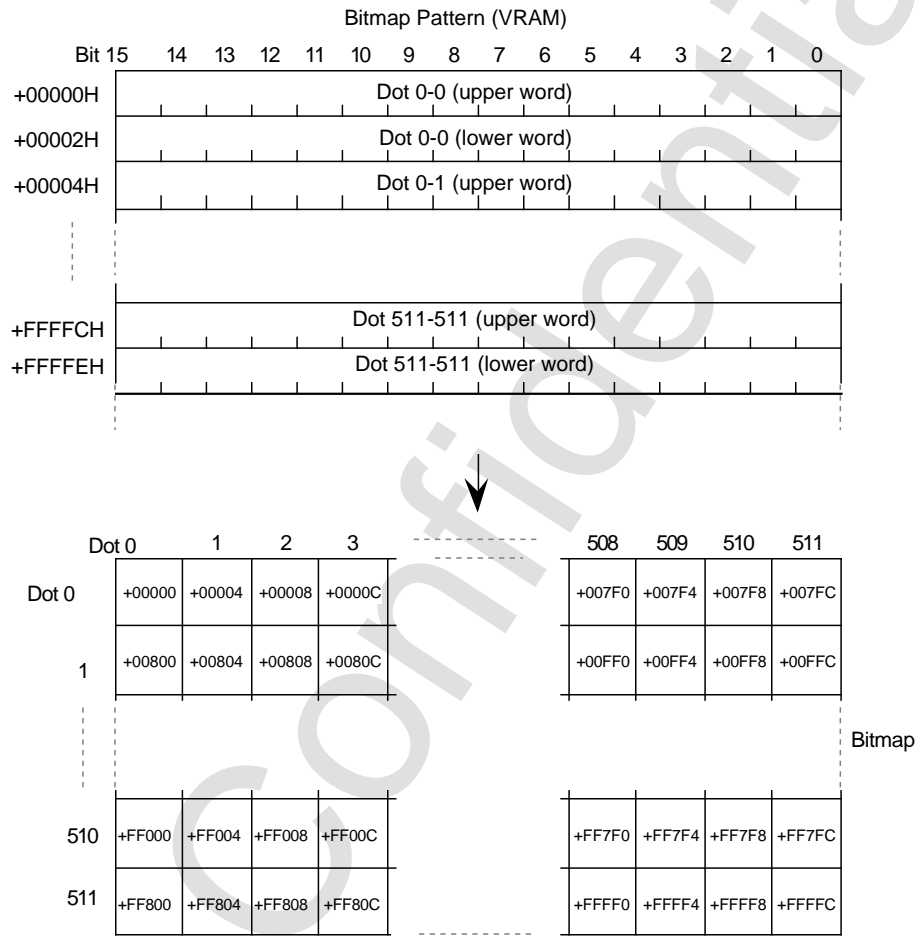

Note 1: The upper left notation in the cell is dot 0-0; to the right are dot 0-1, dot 0-2, dot 0-3, ...

Note 2: Numbers in the cells are VRAM addresses (hexadecimal) of dot data (upper word), with VRAM address of dot 0-0 data (upper word) as the reference.

**Figure 4.17 Bit map pattern configuration (continued)**

- (9) Bitmap Size : 1024 H dots X 256 V dots  
 Bitmap Color Count : 4 bits/dot (16 colors)

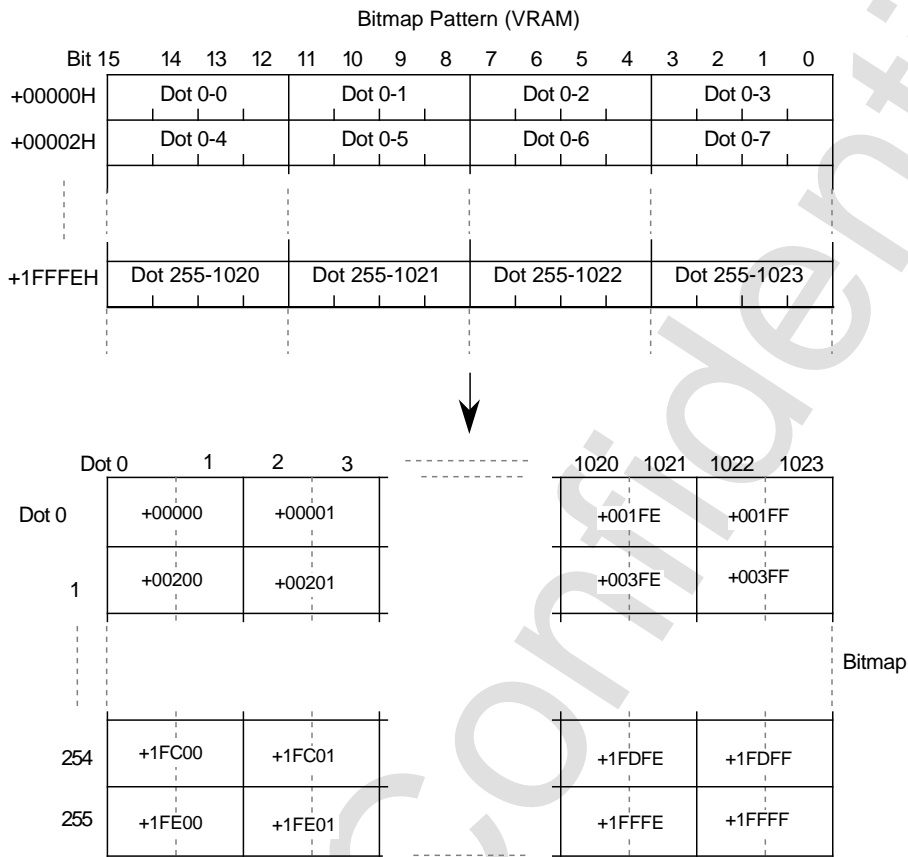

- Note 1: The upper left notation in the cell is dot 0-0; to the right are dot 0-1, dot 0-2, dot 0-3, ...
- Note 2: Numbers in the cells are VRAM addresses (hexadecimal) of dot (2 dots) data, with VRAM address of dot 0-0, 0-1 data as the reference.

**Figure 4.17 Bit map pattern configuration (continued)**



- (10) Bitmap Size : 1024 H dots X 256 V dots  
 Bitmap Color Count : 8 bits/dot (256 colors)

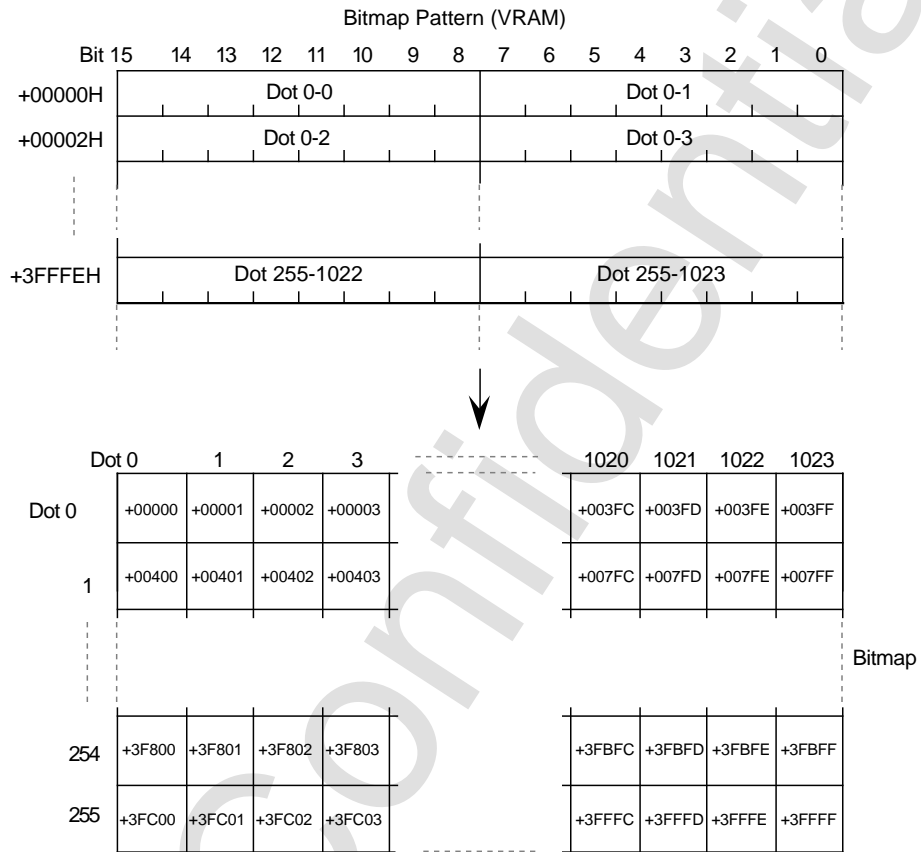

Note 1: The upper left notation in the cell is dot 0-0; to the right are dot 0-1, dot 0-2, dot 0-3, ...

Note 2: Numbers in the cells are VRAM addresses (hexadecimal) of dot data, with VRAM address of dot 0-0 data as the reference.

**Figure 4.17 Bit map pattern configuration (continued)**

(11) Bitmap Size : 1024 H dots X 256 V dots  
 Bitmap Color Count : 16 bits/dot (2048 colors, 32768 colors)

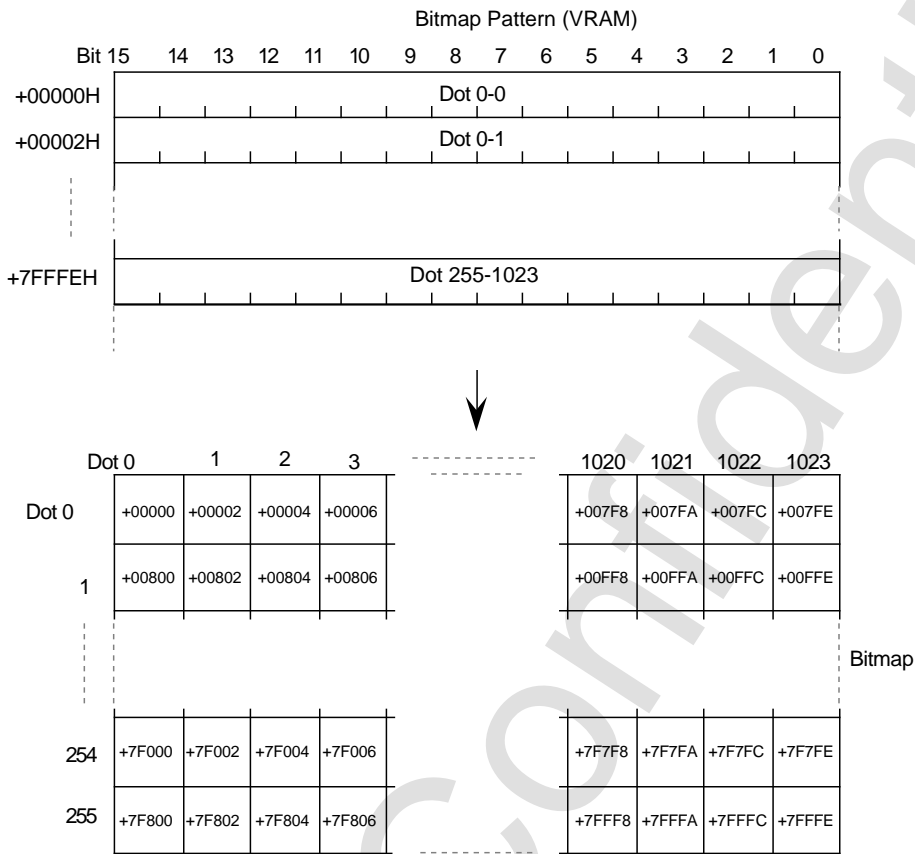

Note 1: The upper left notation in the cell is dot 0-0; to the right are dot 0-1, dot 0-2, dot 0-3, ...

Note 2: Numbers in the cells are VRAM addresses (hexadecimal) of dot data, with VRAM address of dot 0-0 data as the reference.

**Figure 4.17 Bit map pattern configuration (continued)**



(12) Bitmap Size : 1024 H dots X 256 V dots  
 Bitmap Color Count : 32 bits/dot (16,770,000 colors)

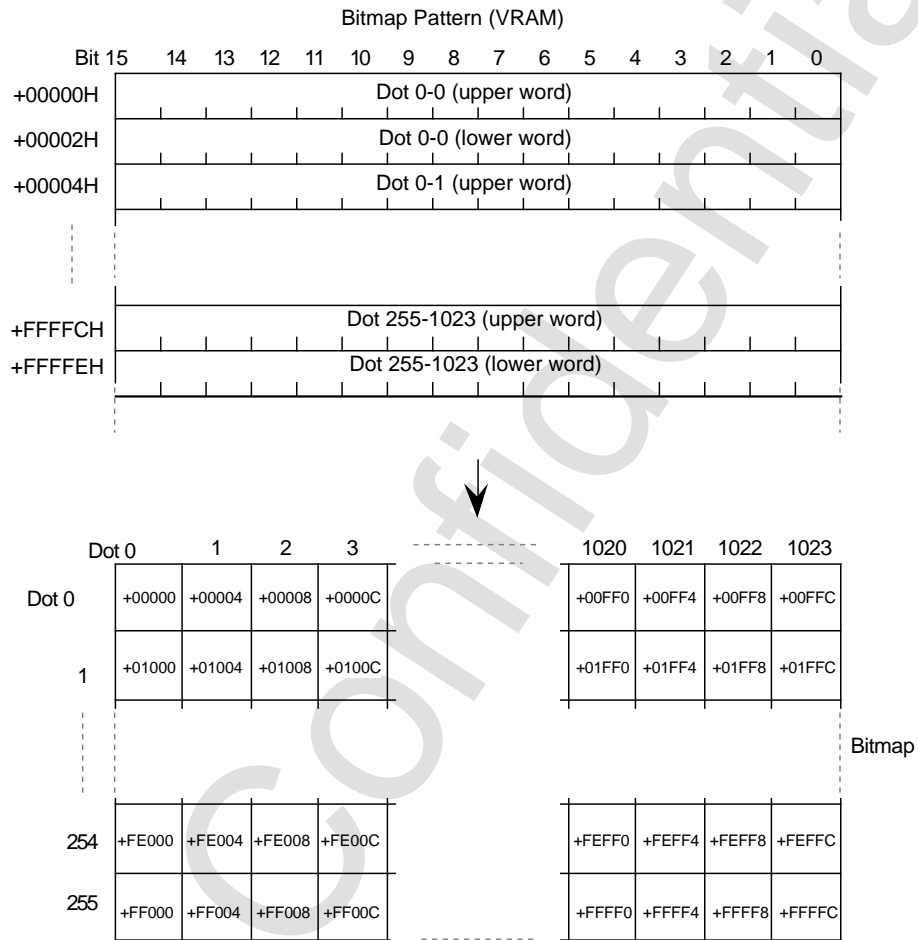

Note 1: The upper left notation in the cell is dot 0-0; to the right are dot 0-1, dot 0-2, dot 0-3, ...

Note 2: Numbers in the cells are VRAM addresses (hexadecimal) of dot data (upper word), with VRAM address of dot 0-0 data (upper word) as the reference.

**Figure 4.17 Bit map pattern configuration (continued)**

(13) Bitmap Size : 1024 H dots X 512 V dots  
 Bitmap Color Count : 4 bits/dot (16 colors)

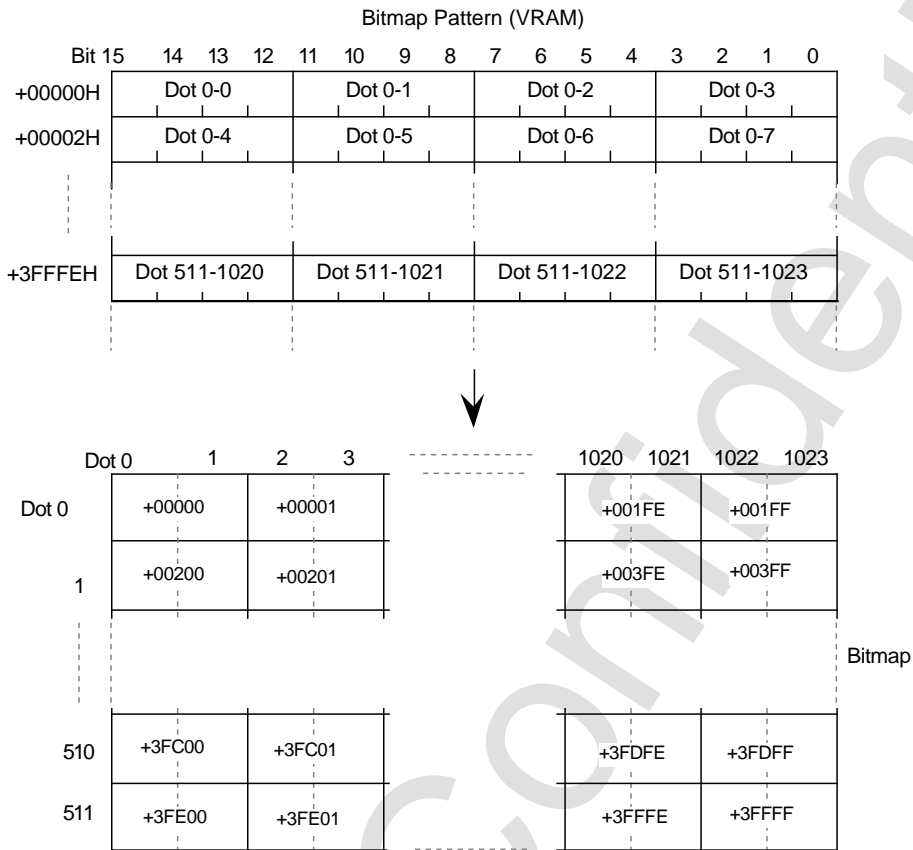

Note 1: The upper left notation in the cell is dot 0-0; to the right are dot 0-1, dot 0-2, dot 0-3, ...  
 Note 2: Numbers in the cells are VRAM addresses (hexadecimal) of dot (2 dots) data, with VRAM address of dot 0-0, 0-1 data as the reference.

**Figure 4.17 Bit map pattern configuration (continued)**



(14) Bitmap Size : 1024 H dots X 512 V dots  
 Bitmap Color Count : 8 bits/dot (256 colors)

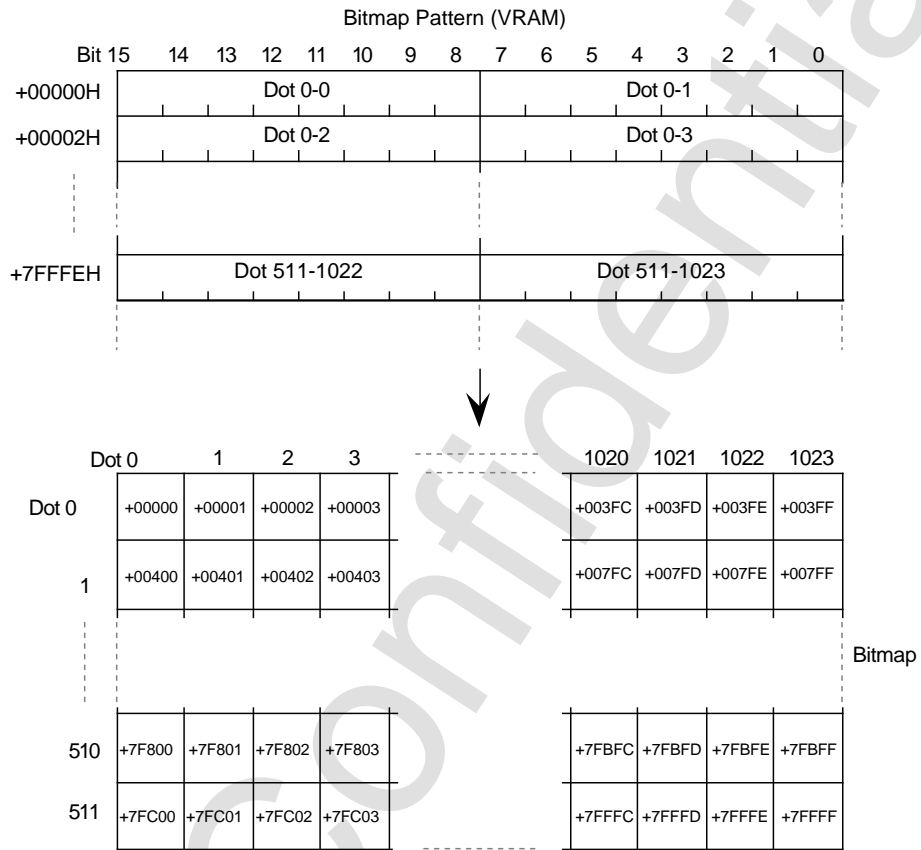

Note 1: The upper left notation in the cell is dot 0-0; to the right are dot 0-1, dot 0-2, dot 0-3, ...

Note 2: Numbers in the cells are VRAM addresses (hexadecimal) of dot data, with VRAM address of dot 0-0 data as the reference.

**Figure 4.17 Bit map pattern configuration (continued)**

(15) Bitmap Size : 1024 H dots X 512 V dots  
 Bitmap Color Count : 16 bits/dot (2048 colors, 32768 colors)

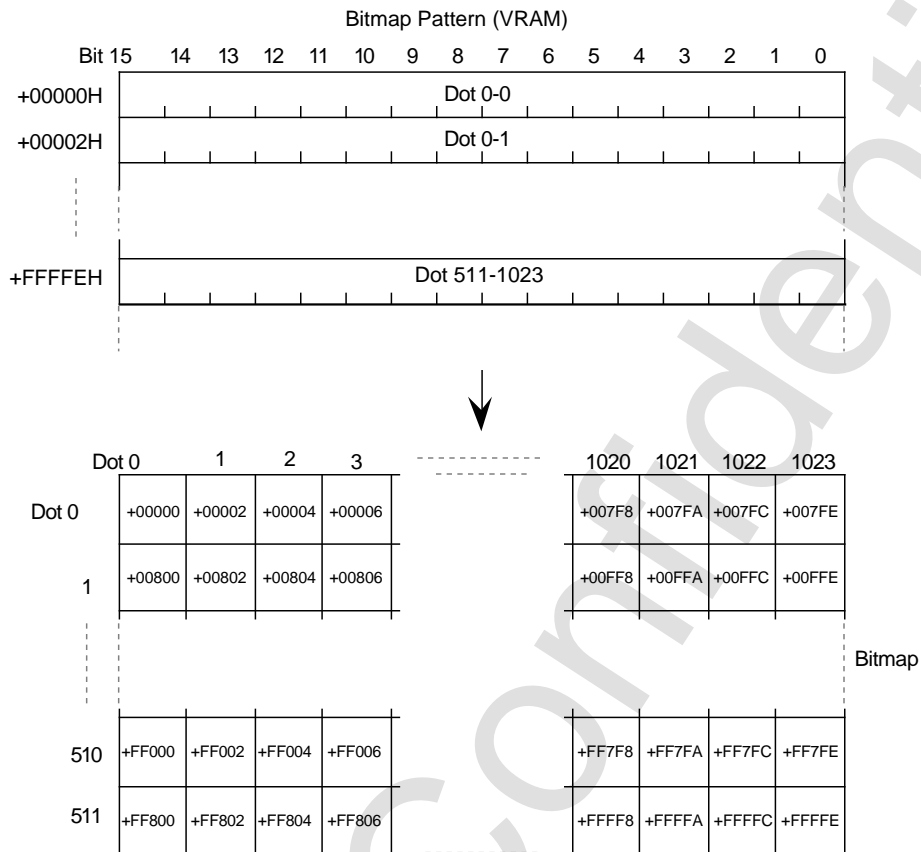

Note 1: The upper left notation in the cell is dot 0-0; to the right are dot 0-1, dot 0-2, dot 0-3, ...  
 Note 2: Numbers in the cells are VRAM addresses (hexadecimal) of dot data, with VRAM address of dot 0-0 data as the reference.

**Figure 4.17 Bit map pattern configuration (continued)**





## Bit Map Palette Number

The bit map palette number designates the lead address of the palette used in the bit map pattern. With the 3-bit data designated by the bit map palette number register, the bit map palette number can only be used when the color format is in the palette format. It cannot be used when in the RGB format. Because the palette number is added to the dot color code of the bit map pattern to make an 11 bit dot color code, the bit count that is used by the color count on each surface changes. Figure 4.18 shows dot color data by bit map number colors.

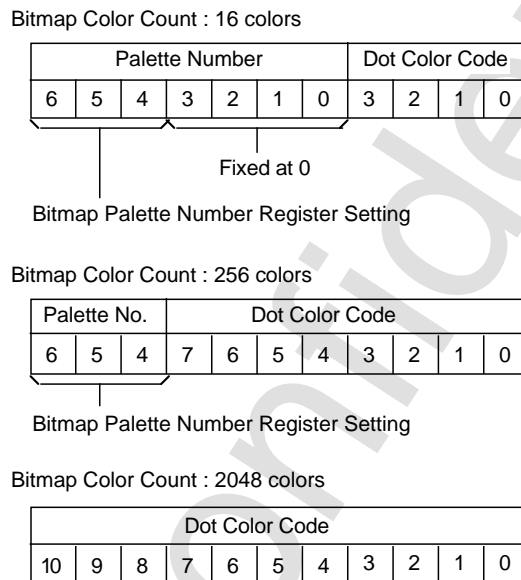

Figure 4.18 Dot color data by bit map color numbers

## Special Function Bit

The special function bit designates whether to use the special function for bit map patterns. The special function bit has a special priority bit that controls the priority number and the special color calculation bit that controls color calculation. For more information on the special priority bit see “11.2 Special Priority Function.” For more information on the color calculation bit see “12.2 Special Color Calculation Function.”

## Bit Map Palette Number Register

Bit map palette number register selects the palette number when the scroll screen is displayed by the bit map format and special function bit. This register is a write-only 16-bit register located in addresses 18002CH to 18002EH. Because the value is cleared to 0 after the power is turned on or reset, make sure the value is set.

	15	14	13	12	11	10	9	8
BMPNA	~	~	N1BMPR	N1BMCC	~	N1BMP6	N1BMP5	N1BMP4
18002CH	7	6	5	4	3	2	1	0
	~	~	N0BMPR	N0BMCC	~	N0BMP6	N0BMP5	N0BMP4
	15	14	13	12	11	10	9	8
BMPNB	~	~	~	~	~	~	~	~
18002EH	7	6	5	4	3	2	1	0
	~	~	R0BMPR	R0BMCC	~	R0BMP6	R0BMP5	R0BMP4

### Special priority bit (for bit map): Bit map special priority bit (N0BMPR, N1BMPR, R0BMPR)

Designates the special priority bit when the scroll screen is displayed by the bit map format.

N0BMPR	18002CH	Bit 5	For NBG0
N1BMPR	18002CH	Bit 13	For NBG1
R0BMPR	18002EH	Bit 5	For RBG0

See section "11.2 Special Priority Function" on how to use this bit.

### Special color calculation bit (for bit map): Bit map special color calculation bit (N0BMCC, N1BMCC, R0BMCC)

Designates the special color calculation bit when the scroll screen is displayed by the bit map format.

N0BMCC	18002CH	Bit 4	For NBG0
N1BMCC	18002CH	Bit 12	For NBG1
R0BMCC	18002EH	Bit 4	For RBG0

See section "12.2 Special Color Calculation Function" on how to use this bit.



**Palette number bit (for bit map): Bit map palette number bit (N0BMP2 to N0BMP0, N1BMP2 to N1BMP0, R0BMP2 to R0BMP0)**

Designates the highest three bits of the palette number when the scroll screen is displayed in the bit map format.

N0BMP6~N0BMP4	18002CH	Bit 2~0	For NBG0
N1BMP6~N1BMP4	18002CH	Bit 10~8	For NBG1
R0BMP6~R0BMP4	18002EH	Bit 2~0	For RBG0

When the bit map color count is 16 colors, a "0" is attached to the lowest four bits and used as the 7-bit palette number.

SEGA Confidential

## 4.10 Display Area

The display area of the scroll screen changes depending on the register setting. The display area image is repeated and displayed when display coordinate values exceed the display area in the Normal scroll screen. Control is executed by the register setting when display coordinate values exceed the display area in the rotation scroll surface.

### Display Area

The display area changes according to the plane size when scroll screen display format is the cell format, and according to the bit map size when in the bit map format. NBG0 and NBG1 also change by setting the reduction display up to 1/4. Tables 4.12 and 4.13 show the display areas.

**Table 4.12 Normal scroll screen display area**

Display Format	Reduction Setting	Plane Size	Bitmap Size	Display Area
Cell format	No reduction~ 1/2 reduction	1 H page X 1 V page	-	$0 \leq X < 1024, 0 \leq Y < 1024$
		2 H pages X 1 V page	-	$0 \leq X < 2048, 0 \leq Y < 1024$
		2 H pages X 2 V pages	-	$0 \leq X < 2048, 0 \leq Y < 2048$
	Up to 1/4 reduction	1 H page X 1 V page	-	$0 \leq X < 1024, 0 \leq Y < 2048$
		2 H pages X 1 V page	-	$0 \leq X < 2048, 0 \leq Y < 2048$
Bitmap Format	-	-	512 H dots X 256 V dots	$0 \leq X < 512, 0 \leq Y < 256$
		-	512 H dots X 512 V dots	$0 \leq X < 512, 0 \leq Y < 512$
		-	1024 H dots X 256 V dots	$0 \leq X < 1024, 0 \leq Y < 256$
		-	1024 H dots X 512 V dots	$0 \leq X < 1024, 0 \leq Y < 512$

**Table 4.13 Rotation Scroll Surface display area**

Display Format	Plane Size	Bitmap Size	Display Area
Cell format	1 H page X 1 V page	-	$0 \leq X < 2048, 0 \leq Y < 2048$
	2 H pages X 1 V page	-	$0 \leq X < 4096, 0 \leq Y < 2048$
	2 H pages X 2 V pages	-	$0 \leq X < 4096, 0 \leq Y < 4096$
Bitmap Format	-	512 H dots X 256 V dots	$0 \leq X < 512, 0 \leq Y < 256$
	-	512 H dots X 512 V dots	$0 \leq X < 512, 0 \leq Y < 512$



## Screen-Over Process

While the rotation scroll surface is displayed, and if the calculated results of display coordinate values of an display area have been exceeded, select one of the four below and set it to the register. The setting of the screen-over process is not performed for RBG0 and RBG1, but is performed for the scroll screen by rotation parameter A and the scroll screen by rotation parameter B.

1. The outside of the display area repeats the image set in the display area.
2. The outside of the display area repeats the character pattern designated by the screen-over pattern name register (only when the rotation scroll surface is in the cell format).
3. The outside of the display area is transparent.
4. With no relationship to the plane size and bit map size, the display area is at  $0 \leq X < 512$  and  $0 \leq Y < 512$ . The outside of the display area is all made to be transparent.

## Display-Over Pattern Name

When the designated character pattern is made to be repeated, pattern name data selects the screen-over control setting in a 16-bit screen-over pattern name register. The screen-over pattern name data selected in the register is handled the same as when the data size of the scroll surface pattern name table is 1-word; it uses supplemental data in the lowest 10 bits of the pattern name control register, supplements insufficient bits, and does screen-over pattern name data of a total 26 bits. The bit configuration of the screen-over pattern name register is the same as when the pattern name data size is 1-word, as in "Pattern Name Table" of section 4.6; and changes depending on character size, character color number, and the character number supplement mode. The size of the repeated character pattern follows the setting of the character size.

16-bit screen over pattern name data designates for the scroll screen by rotation parameter A and scroll screen by rotation parameter B, but you should be careful when designating for RBG0 and RBG1 by 10-bit supplement data designated by the pattern name control register. Besides, screen-over pattern name data cannot be used when the rotation scroll screen is displayed in the bit map format.

## Screen-Over Pattern Name Register

In the screen-over process of the rotation scroll surface, the screen-over pattern name register selects pattern name data when the repetition of the character pattern is set. This register is a write-only 16-bit register and is in addresses 1800B8H to 1800BAH. Because the value is cleared to 0 after the power is turned on or reset, be sure to set the value.

	15	14	13	12	11	10	9	8
OVPNRA	RAOPN15	RAOPN14	RAOPN13	RAOPN12	RAOPN11	RAOPN10	RAOPN9	RAOPN8
1800B8H	7	6	5	4	3	2	1	0
	RAOPN7	RAOPN6	RAOPN5	RAOPN4	RAOPN3	RAOPN2	RAOPN1	RAOPN0
	15	14	13	12	11	10	9	8
OVPNRB	RBOPN15	RBOPN14	RBOPN13	RBOPN12	RBOPN11	RBOPN10	RBOPN9	RBOPN8
1800BAH	7	6	5	4	3	2	1	0
	RBOPN7	RBOPN6	RBOPN5	RBOPN4	RBOPN3	RBOPN2	RBOPN1	RBOPN0

### Over pattern name bit (RAOPN15 to RAOPN0, RBOPN15 to RBOPN0)

Designates pattern name data when the screen-over process repeating the character pattern is set.

RAOPN15~RAOPN0	1800B8H	Bit 15~0	For Rotation Parameter A
RBOPN15~RBOPN0	1800BAH	Bit 15~0	For Rotation Parameter B

The bit configuration is the same as when the data size of the pattern name table is one-word; and changes depending on the settings of the character size, character color number, and character number supplement mode.

This register action is executed for the scroll screen by rotation parameter A and B, but the character size that decides the bit configuration as well as the character number supplement mode performs in RBG0 and RBG1. Therefore, be careful when simultaneously displaying screens by rotation parameter A and B in RBG0.



## 4.11 Mosaic Process

The mosaic process can be done for each screen using the scroll surface. The mosaic size can be set for the respective horizontal and vertical directions. The mosaic process divides each scroll screen into several areas of pre-determined size. This function displays all dots within various areas of colored dots in the upper left. The mosaic pattern can be achieved by aligning different color areas. The size of the mosaic area can be individually selected. Size in the horizontal direction can select from 1 to 16 dots in single dot units. Size in the vertical direction can select from 1 to 16 dots in the non-interlace mode in single dot units, and 2 to 32 dots in the interlace mode in two-dot units. If the register is set to do mosaic processing when in the double-density interlace mode, the screen is made to display in the single-density interlace mode.

When using the mosaic process in NBG0 or NBG1, the vertical cell scroll function can no longer be used. Also, mosaic processing of RBG0 and RBG1 can only be done in the horizontal direction. Figure 4.19 shows the mosaic pattern.

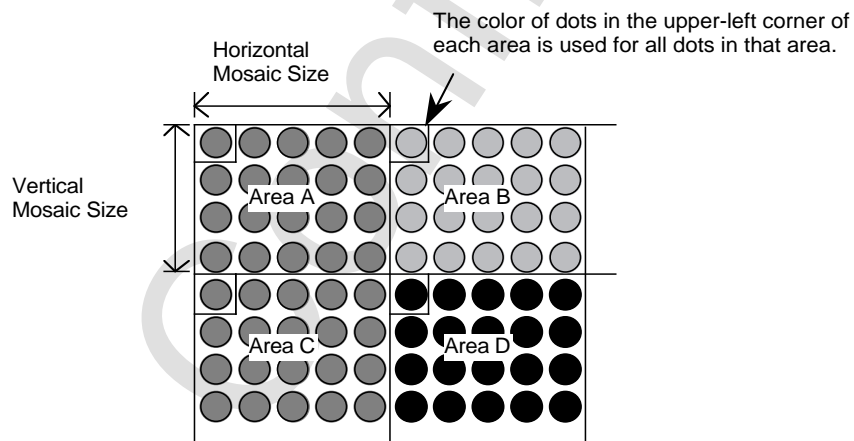

Figure 4.19 Mosaic Pattern

## Mosaic Control Register

The mosaic control register selects whether to perform the mosaic process. It is a write-only 16-bit register and is in address 180022H. Because the value is cleared to 0 after the power is turned on or reset, be sure to set the value.

	15	14	13	12	11	10	9	8
MZCTL	MZSZV3	MZSZV2	MZSZV1	MZSZV0	MZSZH3	MZSZH2	MZSZH1	MZSZH0
180022H	7	6	5	4	3	2	1	0
	~	~	~	ROMZE	N3MZE	N2MZE	N1MZE	N0MZE

### Mosaic size bit (MZSZH3 to MZSZH0, MZSZV3 to MZSZV0)

Designates the horizontal and vertical mosaic size.

MZSZV3~MZSZV0	180022H	Bit 15~12	For vertical mosaic size
MZSZH3~MZSZH0	180022H	Bit 11~8	For horizontal mosaic size

MZSZH3	MZSZH2	MZSZH1	MZSZH0	Horizontal Mosaic Size
0	0	0	0	1 dot
0	0	0	1	2 dots
0	0	1	0	3 dots
0	0	1	1	4 dots
0	1	0	0	5 dots
0	1	0	1	6 dots
0	1	1	0	7 dots
0	1	1	1	8 dots
1	0	0	0	9 dots
1	0	0	1	10 dots
1	0	1	0	11 dots
1	0	1	1	12 dots
1	1	0	0	13 dots
1	1	0	1	14 dots
1	1	1	0	15 dots
1	1	1	1	16 dots





MZSZV3	MZSZV2	MZSZV1	MZSZV0	Vertical Mosaic Size	
				Non-Interlace	Interlace
0	0	0	0	1 dot	2 dots
0	0	0	1	2 dots	4 dots
0	0	1	0	3 dots	6 dots
0	0	1	1	4 dots	8 dots
0	1	0	0	5 dots	10 dots
0	1	0	1	6 dots	12 dots
0	1	1	0	7 dots	14 dots
0	1	1	1	8 dots	16 dots
1	0	0	0	9 dots	18 dots
1	0	0	1	10 dots	20 dots
1	0	1	0	11 dots	22 dots
1	0	1	1	12 dots	24 dots
1	1	0	0	13 dots	26 dots
1	1	0	1	14 dots	28 dots
1	1	1	0	15 dots	30 dots
1	1	1	1	16 dots	32 dots

**Note:** There is no relationship with the interlace setting.

**Mosaic enable bit (N0MZE, N1MZE, N2MZE, N3MZE, R0MZE)**

Designates the screen performing mosaic process.

N0MZE	180022H	Bit 0	For NBG0 (or RBG1)
N1MZE	180022H	Bit 1	For NBG1
N2MZE	180022H	Bit 2	For NBG2
N3MZE	180022H	Bit 3	For NBG3
R0MZE	180022H	Bit 4	For RBG0

xxMZE	Process
0	Does not execute mosaic process
1	Processes mosaic process

**Note:** N0, N1, N2, N3, or R0 is entered in bit name for xx.

Only horizontal mosaic processing is performed when the mosaic process is in the rotation scroll surface. If performing mosaic processing in the double-density interlace mode, the screen is made to be displayed by the single-density interlace mode. If performing mosaic processing in NBG0 or NBG1, the mosaic screen will not be able to use the vertical cell-scroll function. As a result, the mosaic process is done on the display screen for screens that don't cell-scroll vertically.

(This page was blank in the original Japanese document)

SEGA Confidential



## Chapter 5 Normal Scroll Screen

Introduction.....	122
5.1 Screen Scroll Function .....	122
Screen Scroll Value Register .....	123
5.2 Expansion/Contraction Function .....	126
Coordinate Increment Register .....	127
Reduction Enable Register.....	129
5.3 Line and Vertical Cell Scroll Function .....	131
Line Scroll Function .....	131
Vertical Cell Scroll Function.....	134
Line and Vertical Cell Scroll Control Register .....	137
Line Scroll Table Address Register.....	140
Vertical Cell Scroll Table Address Register .....	141

## Introduction

The normal scroll screen has four surfaces, NBG0 to NBG3; each surface can be scrolled up and down, left and right. NBG0 and NBG1 can be expanded and reduced, line scrolled, and cell scrolled vertically.

### 5.1 Screen Scroll Function

All four surfaces of the normal scroll screen can dot scroll up, down, left, or right in surface units. The screen scroll value selects, in the screen scroll value register, the dot coordinates displayed in the upper left of the TV screen. The screen scroll value is in effect up to and including values that don't exceed the display area set for each screen. The display area of the screen is repeated when a value that exceeds the display area is selected. The fractional part of the screen scroll value for NBG0 and NBG1 is used only in calculating coordinates; the final display coordinate values are discarded. The horizontal (X) coordinate is selected by the horizontal screen scroll value integer part bit and horizontal screen scroll value fractional part bit. The vertical (Y) coordinate is selected by the vertical screen scroll value integer part bit and vertical screen scroll value fractional part bit. The fractional part bit is added immediately below the integer bit. Figure 5.1 shows the bit configuration.

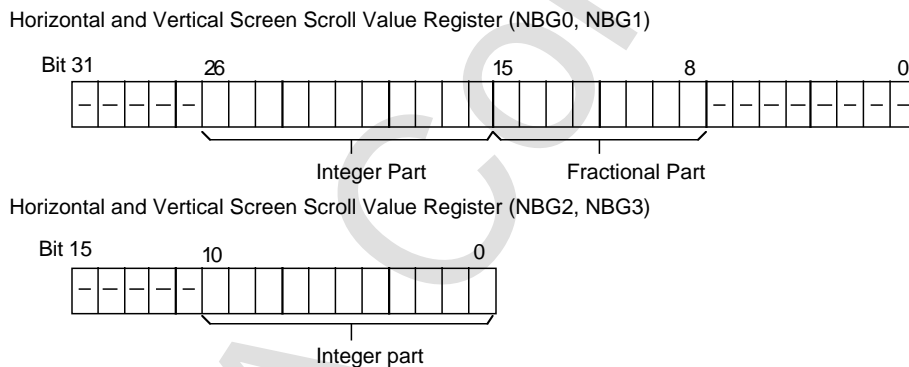

Figure 5.1 Screen scroll value bit configuration



## Screen Scroll Value Register

The screen scroll value register designates the screen scroll value. It is a write-only 16- or 32-bit register located at addresses 180070H to 180076H, 180080H to 180086H, and 180090H to 180096H. Because the value is cleared to 0, it must be set after power on or reset.

	15	14	13	12	11	10	9	8
SCXIN0	~	~	~	~	~	N0SCXI10	N0SCXI9	N0SCXI8
180070H	7	6	5	4	3	2	1	0
	N0SCXI7	N0SCXI6	N0SCXI5	N0SCXI4	N0SCXI3	N0SCXI2	N0SCXI1	N0SCXI0
	15	14	13	12	11	10	9	8
SCXDN0	N0SCXD1	N0SCXD2	N0SCXD3	N0SCXD4	N0SCXD5	N0SCXD6	N0SCXD7	N0SCXD8
180072H	7	6	5	4	3	2	1	0
	~	~	~	~	~	~	~	~
	15	14	13	12	11	10	9	8
SCYIN0	~	~	~	~	~	N0SCYI10	N0SCYI9	N0SCYI8
180074H	7	6	5	4	3	2	1	0
	N0SCYI7	N0SCYI6	N0SCYI5	N0SCYI4	N0SCYI3	N0SCYI2	N0SCYI1	N0SCYI0
	15	14	13	12	11	10	9	8
SCYDN0	N0SCYD1	N0SCYD2	N0SCYD3	N0SCYD4	N0SCYD5	N0SCYD6	N0SCYD7	N0SCYD8
180076H	7	6	5	4	3	2	1	0
	~	~	~	~	~	~	~	~
	15	14	13	12	11	10	9	8
SCXIN1	~	~	~	~	~	N1SCXI10	N1SCXI9	N1SCXI8
180080H	7	6	5	4	3	2	1	0
	N1SCXI7	N1SCXI6	N1SCXI5	N1SCXI4	N1SCXI3	N1SCXI2	N1SCXI1	N1SCXI0
	15	14	13	12	11	10	9	8
SCXDN1	N1SCXD1	N1SCXD2	N1SCXD3	N1SCXD4	N1SCXD5	N1SCXD6	N1SCXD7	N1SCXD8
180082H	7	6	5	4	3	2	1	0
	~	~	~	~	~	~	~	~
	15	14	13	12	11	10	9	8
SCYIN1	~	~	~	~	~	N1SCYI10	N1SCYI9	N1SCYI8
180084H	7	6	5	4	3	2	1	0
	N1SCYI7	N1SCYI6	N1SCYI5	N1SCYI4	N1SCYI3	N1SCYI2	N1SCYI1	N1SCYI0
	15	14	13	12	11	10	9	8
SCYDN1	N1SCYD1	N1SCYD2	N1SCYD3	N1SCYD4	N1SCYD5	N1SCYD6	N1SCYD7	N1SCYD8
180086H	7	6	5	4	3	2	1	0
	~	~	~	~	~	~	~	~

	15	14	13	12	11	10	9	8
SCXN2	~	~	~	~	~	N2SCX10	N2SCX9	N2SCX8
180090H	7	6	5	4	3	2	1	0
	N2SCX7	N2SCX6	N2SCX5	N2SCX4	N2SCX3	N2SCX2	N2SCX1	N2SCX0
	15	14	13	12	11	10	9	8
SCYN2	~	~	~	~	~	N2SCY10	N2SCY9	N2SCY8
180092H	7	6	5	4	3	2	1	0
	N2SCY7	N2SCY6	N2SCY5	N2SCY4	N2SCY3	N2SCY2	N2SCY1	N2SCY0
	15	14	13	12	11	10	9	8
SCXN3	~	~	~	~	~	N3SCX10	N3SCX9	N3SCX8
180094H	7	6	5	4	3	2	1	0
	N3SCX7	N3SCX6	N3SCX5	N3SCX4	N3SCX3	N3SCX2	N3SCX1	N3SCX0
	15	14	13	12	11	10	9	8
SCYN3	~	~	~	~	~	N3SCY10	N3SCY9	N3SCY8
180096H	7	6	5	4	3	2	1	0
	N3SCY7	N3SCY6	N3SCY5	N3SCY4	N3SCY3	N3SCY2	N3SCY1	N3SCY0

**Screen scroll value bit: Scroll bit (N0SCXI10 to N0SCXI0, N0SCXD1 to N0SCXD8, N0SCYI10 to N0SCYI0, N0SCYD1 to N0SCYD8, N1SCXI10 to N1SCXI0, N1SCXD1 to N1SCXD8, N1SCYI10 to N1SCYI0, N1SCYD1 to N1SCYD8, N2SCX10 to N2SCX0, N2SCY10 to N2SCY0, N3SCX10 to N3SCX0, N3SCY10 to N3SCY0)**

Designates the horizontal and vertical screen scroll values (coordinate values) of the Normal scroll screen.

N0SCXI10~N0SCXI0	180070H	Bit 10~0	For NBG0 horizontal direction (integer part)
N0SCXD1~N0SCXD8	180072H	Bit 15~8	For NBG0 horizontal direction (fractional part)
N0SCYI10~N0SCYI0	180074H	Bit 10~0	For NBG0 vertical direction (integer part)
N0SCYD1~N0SCYD8	180076H	Bit 15~8	For NBG0 vertical direction (fractional part)
N1SCXI10~N1SCXI0	180080H	Bit 10~0	For NBG1 horizontal direction (integer part)
N1SCXD1~N1SCXD8	180082H	Bit 15~8	For NBG1 horizontal direction (fractional part)
N1SCYI10~N1SCYI0	180084H	Bit 10~0	For NBG1 vertical direction (integer part)
N1SCYD1~N1SCYD8	180086H	Bit 15~8	For NBG1 vertical direction (fractional part)
N2SCX10~N2SCX0	180090H	Bit 10~0	For NBG2 horizontal direction
N2SCY10~N2SCY0	180092H	Bit 10~0	For NBG2 vertical direction
N3SCX10~N3SCX0	180094H	Bit 10~0	For NBG3 horizontal direction
N3SCY10~N3SCY0	180096H	Bit 10~0	For NBG3 vertical direction



The value of the screen scroll value register is effective up to a range not exceeding the display area of each screen. When the display area is exceeded, the screen of the display area is repeatedly displayed. All screen scroll values must be identified as positive values. By changing the value during the horizontal retrace, the scroll value can also be changed in the middle of the image screen.

SEGA Confidential

## 5.2 Expansion/Contraction Function

NBG0 and NBG1 can expand and reduce the entire screen both horizontally and vertically. Controlling expansion and reduction is done by selecting horizontal and vertical coordinate increments required in display coordinate calculations. When reducing horizontally, the reduction enable register must be set as certain screens cannot be displayed, depending on this setting.

Display coordinates are calculated by the expressions below.

**Note:** the fractional part of the calculated results are discarded.

$$\begin{aligned}(\text{display coordinate value } X) &= (\text{coordinate increment } X) \times (\text{H counter value}) + (\text{screen scroll value } X) \\(\text{display coordinate value } Y) &= (\text{coordinate increment } Y) \times (\text{V counter value}) + (\text{screen scroll value } Y)\end{aligned}$$

Screen expansion and reduction are controlled by setting the horizontal and vertical coordinate increments in the coordinate increment register. The horizontal coordinate increment is selected by the horizontal coordinate increment integer part bit and horizontal coordinate increment fractional part bit. The vertical coordinate increment is selected by the vertical coordinate increment integer part bit and horizontal coordinate increment fractional part bit.

The fractional part bit is added immediately below the integer bit part. Figure 5.2 shows the bit configuration

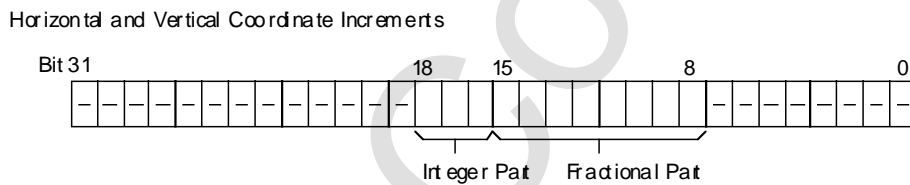

**Figure 5.2 Configuration of coordinate increment register.**





## Coordinate Increment Register

The coordinate increment register designates the coordinate increment when calculating the coordinates of the scroll screen. This is a write-only 32-bit register located at addresses 180078H to 18007EH, and 180088H to 18008EH. Because the value of the register is cleared to 0 after power on or reset, the value must be set.

	15	14	13	12	11	10	9	8
ZMXIN0	~	~	~	~	~	~	~	~
180078H	7	6	5	4	3	2	1	0
	~	~	~	~	~	N0ZMXI2	N0ZMXI1	N0ZMXI0
	15	14	13	12	11	10	9	8
ZMXDN0	N0ZMXD1	N0ZMXD2	N0ZMXD3	N0ZMXD4	N0ZMXD5	N0ZMXD6	N0ZMXD7	N0ZMXD8
18007AH	7	6	5	4	3	2	1	0
	~	~	~	~	~	~	~	~
	15	14	13	12	11	10	9	8
ZMYIN0	~	~	~	~	~	~	~	~
18007CH	7	6	5	4	3	2	1	0
	~	~	~	~	~	N0ZMYI2	N0ZMYI1	N0ZMYI0
	15	14	13	12	11	10	9	8
ZMYDN0	N0ZMYD1	N0ZMYD2	N0ZMYD3	N0ZMYD4	N0ZMYD5	N0ZMYD6	N0ZMYD7	N0ZMYD8
18007EH	7	6	5	4	3	2	1	0
	~	~	~	~	~	~	~	~
	15	14	13	12	11	10	9	8
ZMXIN1	~	~	~	~	~	~	~	~
180088H	7	6	5	4	3	2	1	0
	~	~	~	~	~	N1ZMXI2	N1ZMXI1	N1ZMXI0
	15	14	13	12	11	10	9	8
ZMXDN1	N1ZMXD1	N1ZMXD2	N1ZMXD3	N1ZMXD4	N1ZMXD5	N1ZMXD6	N1ZMXD7	N1ZMXD8
18008AH	7	6	5	4	3	2	1	0
	~	~	~	~	~	~	~	~
	15	14	13	12	11	10	9	8
ZMYIN1	~	~	~	~	~	~	~	~
18008CH	7	6	5	4	3	2	1	0
	~	~	~	~	~	N1ZMYI2	N1ZMYI1	N1ZMYI0
	15	14	13	12	11	10	9	8
ZMYDN1	N1ZMYD1	N1ZMYD2	N1ZMYD3	N1ZMYD4	N1ZMYD5	N1ZMYD6	N1ZMYD7	N1ZMYD8
18008EH	7	6	5	4	3	2	1	0
	~	~	~	~	~	~	~	~

**Coordinate increment bit: Zoom bit (N0ZMXI2 to N0ZMXI0, N0ZMXD1 to N0ZMXD8, N0ZMYI2 to N0ZMYI0, N0ZMYD1 to N0ZMYD8, N1ZMXI2 to N1ZMXI0, N1ZMXD1 to N1ZMXD8, N1ZMYI2 to N1ZMYI0, N1ZMYD1 to N1ZMYD8)**

Designates horizontal and vertical coordinate increments for calculating display coordinates when expanding and reducing all Normal scroll screens.

N0ZMXI2~N0ZMXI0	180078H	Bit 2~0	For NBG0 horizontal direction (integer part)
N0ZMXD1~N0ZMXD8	18007AH	Bit 15~8	For NBG0 horizontal direction (fractional part)
N0ZMYI2~N0ZMYI0	18007CH	Bit 2~0	For NBG0 vertical direction (integer part)
N0ZMYD1~N0ZMYD8	18007EH	Bit 15~8	For NBG0 vertical direction (fractional part)
N1ZMXI2~N1ZMXI0	180088H	Bit 2~0	For NBG1 horizontal direction (integer part)
N1ZMXD1~N1ZMXD8	18008AH	Bit 15~8	For NBG1 horizontal direction (fractional part)
N1ZMYI2~N1ZMYI0	18008CH	Bit 2~0	For NBG1 vertical direction (integer part)
N1ZMYD1~N1ZMYD8	18008EH	Bit 15~8	For NBG1 vertical direction (fractional part)

The coordinate increment should be a value smaller than “1” in the expansion display, and larger than “1” in the reduction display. The normal display is when the coordinate increment is 1. Selections are all by positive values. The coordinate parts of NBG2 and NBG3 are fixed at “1”.

By changing the value during the horizontal retrace, the coordinate increment value can also be changed.

The reduction enable register must be set when reduction display is horizontal. Depending on the setting of the reduction enable bit, do not set horizontal coordinate increment to a value other than the set range decided upon. Table 5.1 shows coordinate increments and reduction settings in the horizontal direction.

**Table 5.1 Horizontal coordinate increments and reduction settings**

Horizontal Reduction Display Setting	Horizontal Coordinate Increment Setting Range
Not allowed	$0 \leq (\text{Horizontal Coordinate Increment}) \leq 1$
Up to 1/2	$0 \leq (\text{Horizontal Coordinate Increment}) \leq 2$
Up to 1/4	$0 \leq (\text{Horizontal Coordinate Increment}) \leq 4$



## Reduction Enable Register

The reduction enable register is a write-only 16 bit register that controls the horizontal reduction display, and is located at address 180098H. Because the value of the register is cleared to 0 after power on or reset, the value must be set.

	15	14	13	12	11	10	9	8
ZMCTL	~	~	~	~	~	~	N1ZMQT	N1ZMHF
180098H	7	6	5	4	3	2	1	0
	~	~	~	~	~	~	N0ZMQT	N0ZMHF

### Reduction enable bit: Zoom quarter/half bit (N1ZMQT, N1ZMHF, N0ZMQT, N0ZMHF)

Designates the maximum reducible range of each Normal scroll screen in the horizontal direction.

N0ZMHF	180098H	Bit 0	For NBG0
N0ZMQT	180098H	Bit 1	For NBG0
N1ZMHF	180098H	Bit 8	For NBG1
N1ZMQT	180098H	Bit 9	For NBG1

NxZMQT	NxZMHF	Horizontal Reduction Display	Restriction Items
0	0	Not allowed	None
0	1	Up to 1/2	The number of character colors can be set for 16 or 256 colors only.
1	0	Up to 1/4	The number of character colors can be set for 16 colors only.
1	1	Up to 1/4	The number of character colors can be set for 16 colors only.

**Note:** 0 or 1 is entered in bit name for x.

For reduction of up to 1/2, set the corresponding screen character color count (bit map pattern color count) to 16 or 256 colors. For reduction of up to 1/4, set to 16 colors. The horizontal coordinate increment should not exceed the set range of these bits.

Certain screens cannot display depending on the reduction setting. Limits are shown in Table 5.2.

**Table 5.2 Display screen limits by setting of reduction enable bit**

Screen	Character Color Count (Bitmap Color Count)	Reduction Enable Setting	Screens That Cannot Display
NBG0	16 Colors	Up to 1/2	None
		Up to 1/4	NBG2
NBG1	256 Colors	Up to 1/2	NBG2
	16 Colors	Up to 1/2	None
		Up to 1/4	NBG3
	256 Colors	Up to 1/2	NBG3



### 5.3 Line and Vertical Cell Scroll Function

Within the Normal scroll screen, there is a line scroll function and vertical cell scroll function in NBG0 and NBG1. The line scroll function selects the horizontal and vertical screen scroll value and horizontal coordinate increment in line units. The vertical cell scroll function selects the vertical screen scroll value in horizontal cell units. Both functions can be used without relationship to the cell format and bit map format.

#### Line Scroll Function

The line scroll function selects the horizontal and vertical screen scroll value and horizontal coordinate increment in line units, and specifies by line scroll tables stored in VRAM. Data values of line scroll tables are designated by relative values. To values stored in line scroll tables, values selected in the screen scroll value register are added, becoming display coordinates. The table data read interval can be selected from four types, one line, two line, four line, and eight line. Values of the vertical coordinate increment register are used for vertical coordinate calculations when two-line intervals or greater are selected.

The horizontal coordinate increment should not set a value that exceeds the setting of the reduction enable register. The line scroll function is shown in Figure 5.3.

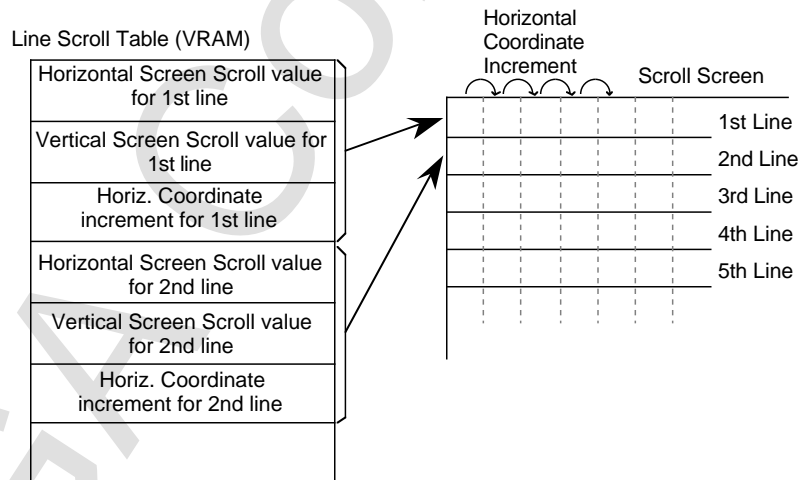

Figure 5.3 Line scroll function

Line scroll tables store from small addresses in order of the horizontal screen scroll value, vertical screen scroll value, and horizontal coordinate increments. Stored line scroll data is only composed of data required by the line scroll register setting.

Each horizontal screen scroll value, vertical screen scroll value, and horizontal coordinate increment configuration is identical to the data configuration set in each register. Figure 5.4 shows the bit configuration of line scroll table data. Table 5.5 shows the configuration of line scroll tables.

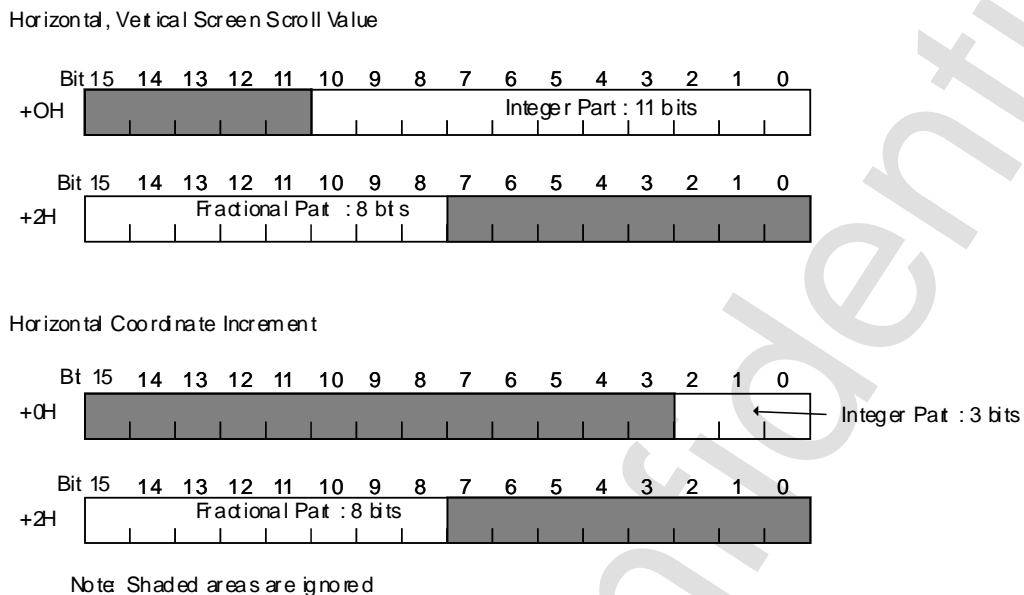
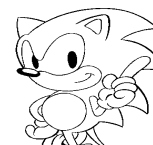

Figure 5.4 Bit configuration of line scroll table data



When selecting horizontal and vertical screen scroll values and horizontal coordinate increment for every 1 line.

		Bit 15	Line Scroll Table (VRAM)	0
Line Scroll Table Address	→ +00H		Line 1 Horiz. Screen Scroll Value (Integer Part)	
		+02H	Line 1 Horiz. Screen Scroll Value (Fractional Part)	
		+04H	Line 1 Vertical Screen Scroll Value (Integer Part)	
		+06H	Line 1 Vertical Screen Scroll Value (Fractional Part)	
		+08H	Line 1 Horiz. Coordinate Increment (Integer Part)	
		+0AH	Line 1 Horiz. Coordinate Increment (Fractional Part)	
		+0CH	Line 2 Horiz. Screen Scroll Value (Integer Part)	
		+0EH	Line 2 Horiz. Screen Scroll Value (Fractional Part)	
		+10H	Line 2 Vertical Screen Scroll Value (Integer Part)	
		+12H	Line 2 Vertical Screen Scroll Value (Fractional Part)	
		+14H	Line 2 Horiz. Coordinate Increment (Integer Part)	
		+16H	Line 2 Horiz. Coordinate Increment (Fractional Part)	

When selecting vertical screen scroll value and horizontal coordinate increment for every 2 lines (no horizontal line scroll).

		Bit 15	Line Scroll Table (VRAM)	0
Line Scroll Table Address	→ +00H		Line 1 Vertical Screen Scroll Value (Integer Part)	
		+02H	Line 1 Vertical Screen Scroll Value (Fractional Part)	
		+04H	Line 1, 2 Horiz. Coordinate Increment (Integer Part)	
		+06H	Line 1, 2 Horiz. Coordinate Increment (Fractional Part)	
		+08H	Line 3 Vertical Screen Scroll Value (Integer Part)	
		+0AH	Line 3 Vertical Screen Scroll Value (Fractional Part)	
		+0CH	Line 3, 4 Horiz. Coordinate Increment (Integer Part)	
		+0EH	Line 3, 4 Horiz. Coordinate Increment (Fractional Part)	

Note: Display coordinates in the vertical direction for lines not specified are obtained by adding coordinate increments in the vertical direction to the vertical screen scroll values for the lines specified.

When selecting horizontal screen scroll value and horizontal coordinate increment for every 4 lines (no horizontal line scroll).

		Bit 15	Line Scroll Table (VRAM)	0
Line Scroll Table Address	→ +00H		Line 1~4 Horiz. Screen Scroll Value (Integer Part)	
		+02H	Line 1~4 Horiz. Screen Scroll Value (Fractional Part)	
		+04H	Line 1~4 Horiz. Coordinate Increment (Integer Part)	
		+06H	Line 1~4 Horiz. Coordinate Increment (Fractional Part)	
		+08H	Line 5~8 Horiz. Screen Scroll Value (Integer Part)	
		+0AH	Line 5~8 Horiz. Screen Scroll Value (Fractional Part)	
		+0CH	Line 5~8 Lines Horiz. Coordinate Increment (Integer Part)	
		+0EH	Line 5~8 Lines Horiz. Coordinate Increment (Fractional Part)	

**Figure 5.5 Line scroll table**

## Vertical Cell Scroll Function

The vertical cell scroll function selects the vertical screen scroll value in horizontal cell units in each vertically separated area, and is selected by the vertical cell scroll table stored in VRAM. The data value of the vertical cell scroll table is designated by relative values. The value selected by the screen scroll value register is added to the screen scroll value stored in the vertical cell scroll table, becoming the display coordinate. Selection can be done in horizontal 8 dot units when displaying in bit map format.

NBG0 and NBG1 have the only vertical cell scroll functions inside the Normal scroll screen. This vertical cell scroll function and mosaic function can not be used simultaneously; the mosaic function has priority. Figure 5.6 shows the vertical cell scroll function.

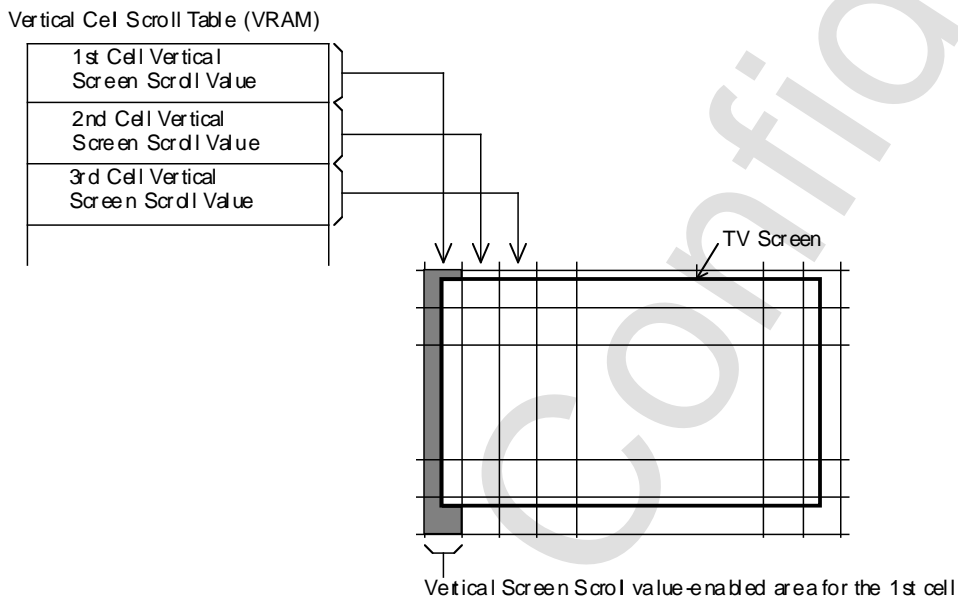

**Figure 5.6 Vertical cell scroll function**

The bit configuration of the vertical screen scroll value is the same when set in all registers. Data of the vertical cell scroll table is treated as a table in the order from data in the left side cell of the TV screen.

When both NBG0 and NBG1 use the vertical cell scroll function, the various vertical cell scroll table data should be alternately stored in NBG0 and NBG1, one cell at a time.





Figure 5.7 shows the bit configuration of the vertical cell scroll table data. Figure 5.8 shows the vertical cell scroll table configuration.

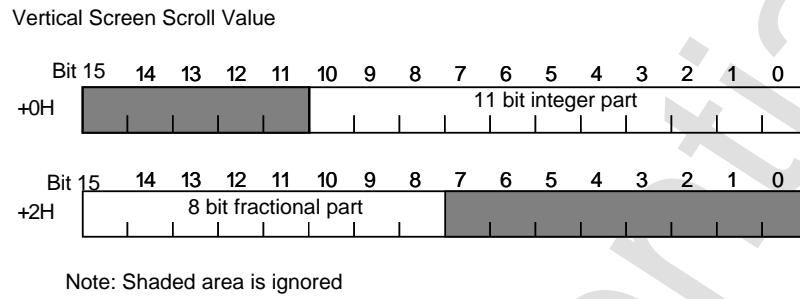

**Figure 5.7** Data configuration on the vertical cell scroll table

NBG0 Vertical Cell Scroll

	Bit 15	Vertical Cell Scroll Table (VRAM)	0
Vertical Cell Scroll Table Address →	+00H	NBG0 1st cell vertical screen scroll value (integer part)	
	+02H	NBG0 1st cell vertical screen scroll value (fractional part)	
	+04H	NBG0 2nd cell vertical screen scroll value (integer part)	
	+06H	NBG0 2nd cell vertical screen scroll value (fractional part)	
	+08H	NBG0 3rd cell vertical screen scroll value (integer part)	
	+0AH	NBG0 3rd cell vertical screen scroll value (fractional part)	
	+0CH	NBG0 4th cell vertical screen scroll value (integer part)	
	+0EH	NBG0 4th cell vertical screen scroll value (fractional part)	
	+10H	NBG0 5th cell vertical screen scroll value (integer part)	
	+12H	NBG0 5th cell vertical screen scroll value (fractional part)	

NBG1 Vertical Cell Scroll

	Bit 15	Vertical Cell Scroll Table (VRAM)	0
Vertical Cell Scroll Table Address →	+00H	NBG1 1st cell vertical screen scroll value (integer part)	
	+02H	NBG1 1st cell vertical screen scroll value (fractional part)	
	+04H	NBG1 2nd cell vertical screen scroll value (integer part)	
	+06H	NBG1 2nd cell vertical screen scroll value (fractional part)	
	+08H	NBG1 3rd cell vertical screen scroll value (integer part)	
	+0AH	NBG1 3rd cell vertical screen scroll value (fractional part)	
	+0CH	NBG1 4th cell vertical screen scroll value (integer part)	
	+0EH	NBG1 4th cell vertical screen scroll value (fractional part)	
	+10H	NBG1 5th cell vertical screen scroll value (integer part)	
	+12H	NBG1 5th cell vertical screen scroll value (fractional part)	

NBG0 and NBG1 Vertical Cell Scroll

	Bit 15	Vertical Cell Scroll Table (VRAM)	0
Vertical Cell Scroll Table Address →	+00H	NBG0 1st cell vertical screen scroll value (integer part)	
	+02H	NBG0 1st cell vertical screen scroll value (fractional part)	
	+04H	NBG1 1st cell vertical screen scroll value (integer part)	
	+06H	NBG1 1st cell vertical screen scroll value (fractional part)	
	+08H	NBG0 2nd cell vertical screen scroll value (integer part)	
	+0AH	NBG0 2nd cell vertical screen scroll value (fractional part)	
	+0CH	NBG1 2nd cell vertical screen scroll value (integer part)	
	+0EH	NBG1 2nd cell vertical screen scroll value (fractional part)	
	+10H	NBG0 3rd cell vertical screen scroll value (integer part)	
	+12H	NBG0 3rd cell vertical screen scroll value (fractional part)	

Figure 5.8 Vertical cell scroll table



## Line and Vertical Cell Scroll Control Register

The line and vertical cell scroll control register is a write-only 16-bit register that controls the line scroll function and vertical cell scroll function, and is at address 18009AH. Because the value of the register is cleared to 0 after the power is turned on or reset, the value must be set.

	15	14	13	12	11	10	9	8
SCRCTL	~	~	N1LSS1	N1LSS0	N1LZMX	N1LSCY	N1LSCX	N1VCSC
18009AH	7	6	5	4	3	2	1	0
	~	~	N0LSS1	N0LSS0	N0LZMX	N0LSCY	N0LSCX	N0VCSC

### Line Scroll Interval Bit: Line scroll select bit (N0LSS1, N0LSS0, N1LSS1, N1LSS0)

Designates the interval that reads line scroll table data from the table. The interval changes depending on the interlace of the TV screen.

N0LSS1, N0LSS0	18009AH	Bit 5, 4	For NBG0
N1LSS1, N1LSS0	18009AH	Bit 13,12	For NBG1

NxLSS1	NxLSS0	Interlace Setting		
		Non-Interlace	Single-Density Interlace	Double-Density Interlace
0	0	Each line	Every 2 lines	Each line
0	1	Every 2 lines	Every 4 lines	Every 2 lines
1	0	Every 4 lines	Every 8 lines	Every 4 lines
1	1	Every 8 lines	Every 16 lines	Every 8 lines

**Note:** 0 or 1 is entered in bit name for x.

When reading line scroll table data at intervals of two lines or greater, line horizontal scroll screen value not read and horizontal coordinate increments use line scroll data that has been previously read. The vertical scroll screen value is calculated from vertical coordinate increment register value and line scroll data that was previously read.

**Line zoom enable bit: Line zoom X enable bit (N1LZMX, N0LZMX)**

Designates whether expansion-reduction is done horizontally in line units.

N0LZMX	18009AH	Bit 3	For NBG0
N1LSCX	18009AH	Bit 11	For NBG1
NxLZMX		Process	
0		Does not scale horizontally per line units	
1		Scales horizontally per line units	

**Note:** 0 or 1 is entered in bit name for x.

When using this function, the horizontal coordinate increment must be stored in the line scroll table of VRAM. Make sure that the horizontal coordinate increment does not exceed the reduction setting.

**Line scroll enable bit (for the vertical screen scroll value): Line scroll Y enable bit (N1LSCY, N0LSCY)**

Designates whether scroll is performed by vertical line units.

N0LSCY	18009AH	Bit 2	For NBG0
N1LSCY	18009AH	Bit 10	For NBG1
NxLSCY		Process	
0		Does not scroll vertically per line units	
1		Scrolls vertically per line units	

**Note:** 0 or 1 is entered in bit name for x.

When using this function, the vertical screen scroll value must be stored in the line scroll table of VRAM.



**Line scroll enable bit (for the horizontal screen scroll value): Line scroll X enable bit (N1LSCX, N0LSCX)**

Designates whether scroll is performed by horizontal line units.

N0LSCX	18009AH	Bit 1	For NBG0
N1LSCX	18009AH	Bit 9	For NBG1

NxLSCX	Process
0	Does not scroll horizontally per line units
1	Scrolls horizontally per line units

**Note:** 0 or 1 is entered in bit name for x.

When using this function, be sure to store the horizontal scroll screen value in the VRAM line scroll table.

**Vertical cell scroll enable bit (N1VCSC, N0VCSC)**

Designates whether to perform vertical cell scroll.

N0VCSC	18009AH	Bit 0	For NBG0
N1VCSC	18009AH	Bit 8	For NBG1

NxVCSC	Process
0	Does not cell-scroll vertically
1	Cell-scrolls vertically

**Note:** 0 or 1 is entered in bit name for x.

When using the vertical cell scroll function, make sure the access command of the vertical cell scroll table data read is designated in the VRAM cycle pattern register. In addition, vertical cell scroll data must be stored in VRAM. The vertical cell scroll function cannot be used simultaneously with the mosaic function; the mosaic function has priority.

## Line Scroll Table Address Register

The line scroll table address register is a write-only 32-bit register that selects the lead address of the line scroll table, and is at addresses 1800A0H to 1800A6H. Because the value of the register is cleared to 0 after power on or reset, the value must be set.

	15	14	13	12	11	10	9	8
LSTA0U	~	~	~	~	~	~	~	~
1800A0H	7	6	5	4	3	2	1	0
	~	~	~	~	~	N0LSTA18	N0LSTA17	N0LSTA16
	15	14	13	12	11	10	9	8
LSTA0L	N0LSTA15	N0LSTA14	N0LSTA13	N0LSTA12	N0LSTA11	N0LSTA10	N0LSTA9	N0LSTA8
1800A2H	7	6	5	4	3	2	1	0
	N0LSTA7	N0LSTA6	N0LSTA5	N0LSTA4	N0LSTA3	N0LSTA2	N0LSTA1	~
	15	14	13	12	11	10	9	8
LSTA1U	~	~	~	~	~	~	~	~
1800A4H	7	6	5	4	3	2	1	0
	~	~	~	~	~	N1LSTA18	N1LSTA17	N1LSTA16
	15	14	13	12	11	10	9	8
LSTA1L	N1LSTA15	N1LSTA14	N1LSTA13	N1LSTA12	N1LSTA11	N1LSTA10	N1LSTA9	N1LSTA8
1800A6H	7	6	5	4	3	2	1	0
	N1LSTA7	N1LSTA6	N1LSTA5	N1LSTA4	N1LSTA3	N1LSTA2	N1LSTA1	~

### Line scroll table address bit (N0LSTA18 to N0LSTA16, N0LSTA15 to N0LSTA1, N1LSTA18 to N1LSTA16, N1LSTA15 to N1LSTA1)

Designates the lead address of the line scroll table on the VRAM.

N0LSTA18~N0LSTA16	1800A0H	Bit 2~0	For NBG0 (upper bit)
N0LSTA15~N0LSTA1	1800A2H	Bit 15~1	For NBG0 (lower bit)
N1LSTA18~N1LSTA16	1800A4H	Bit 2~0	For NBG1 (upper bit)
N1LSTA15~N1LSTA1	1800A6H	Bit 15~1	For NBG1 (lower bit)

The actual lead VRAM address is calculated by the expression below. When the VRAM has a 4 Mbit capacity, the address of the most significant bit is ignored.

$$\begin{aligned} & \text{(line scroll table lead address)} \\ & = \text{(line scroll table address register value 18 bit)} \times 4\text{H} \end{aligned}$$



## Vertical Cell Scroll Table Address Register

The vertical cell scroll table address register is a write-only 32-bit register that selects the lead address of the vertical cell scroll table, and is at addresses 18009CH to 18009EH. Because the value of the register is cleared to 0 after power on or reset, the value must be set.

	15	14	13	12	11	10	9	8
VCSTAU	~	~	~	~	~	~	~	~
18009CH	7	6	5	4	3	2	1	0
	~	~	~	~	~	VCSTA18	VCSTA17	VCSTA16

	15	14	13	12	11	10	9	8
VCSTAL	VCSTA15	VCSTA14	VCSTA13	VCSTA12	VCSTA11	VCSTA10	VCSTA9	VCSTA8
18009EH	7	6	5	4	3	2	1	0
	VCSTA7	VCSTA6	VCSTA5	VCSTA4	VCSTA3	VCSTA2	VCSTA1	~

### Vertical cell scroll table address bit (VCSTA18 to VCSTA1),

Designates the lead address of the vertical cell scroll table on the VRAM.

VCSTA18~VCSTA16	18009CH	Bit 2~0	
VCSTA15~VCSTA1	18009EH	Bit 15~1	

The actual lead VRAM address is calculated by the expression below. When the VRAM has a 4 Mbit capacity, the address of the most significant bit is ignored.

$$\begin{aligned} & \text{(vertical cell scroll table lead address)} \\ & = \text{(vertical cell scroll table address register value 18 bit)} \times 4\text{H} \end{aligned}$$

(This page is blank in the original Japanese document)

SEGA Confidential





## Chapter 6 Rotation Scroll Screen

Introduction .....	144
6.1 Rotation Scroll Coordinate Operation .....	144
6.2 Rotation Scroll Screen Display Control .....	148
RAM Control Register .....	148
6.3 Rotation Parameter Control .....	151
Data Configuration of the Rotation Parameter Table ....	153
Rotation Parameter Table .....	155
Rotation Parameter Read Control Register .....	157
Rotation Parameter Table Address Register .....	158
Rotation Read Out of the Frame Buffer .....	159
Rotation Parameter Change .....	160
Rotation Parameter Mode Register .....	162
6.4 Coefficient Table Control .....	163
Line Color Screen Data .....	164
Bit Configuration of Coefficient Table Data .....	165
Coefficient Table Lead Address .....	165
Most Significant Bit of Coefficient Data .....	166
RAM Control Register .....	167
Coefficient Table Control Register .....	168
Coefficient Table Address Offset Register .....	170

## Introduction

The rotation scroll screen has two sets of parameter tables called “Rotation parameter A” and “Rotation parameter B” that can be simultaneously displayed by various parameter tables. Besides being stored as rotation parameters in VRAM, the two sets of parameters can hold various correlated coefficient tables in VRAM.

There are two sets of rotation parameters, rotation parameter A and rotation parameter B, each stored in a table. RBG0 can simultaneously display one screen selected by rotation parameter A or rotation parameter B, or two screens selected by rotation parameter A and rotation parameter B. RBG1 can display only the screen designated by rotation parameter B. Table 6.1 shows the relationship between the rotation scroll screen and rotation parameters.

**Table 6.1 Rotation scroll screen**

Screen	Single Display	In Relation to Rotation Parameters
RBG0	Allowed	Screen specified by either rotation parameter A or B, or 2 screens specified by rotation parameters A and B are displayed concurrently
RBG1	Not allowed (RBG0 must also be displayed)	Screen specified by rotation parameter B is displayed

Rotation parameter A and rotation parameter B can each have a coefficient table; there can be multiple displays by reading the coefficient data in each line or each dot. Using rotation parameter A, expansion-reduction rotation of sprite frame buffers can also be done.

### 6.1 Rotation Scroll Coordinate Calculation

The display screen of the rotation scroll screen, which causes rotational conversion (including parallel moving) of the viewpoint reference center point and TV screen, is a collection of points intersecting the line of vision that passes through the TV screen from the viewpoint after conversion with the fixed scroll map. Figure 6.1 shows display method of the rotation scroll screen.



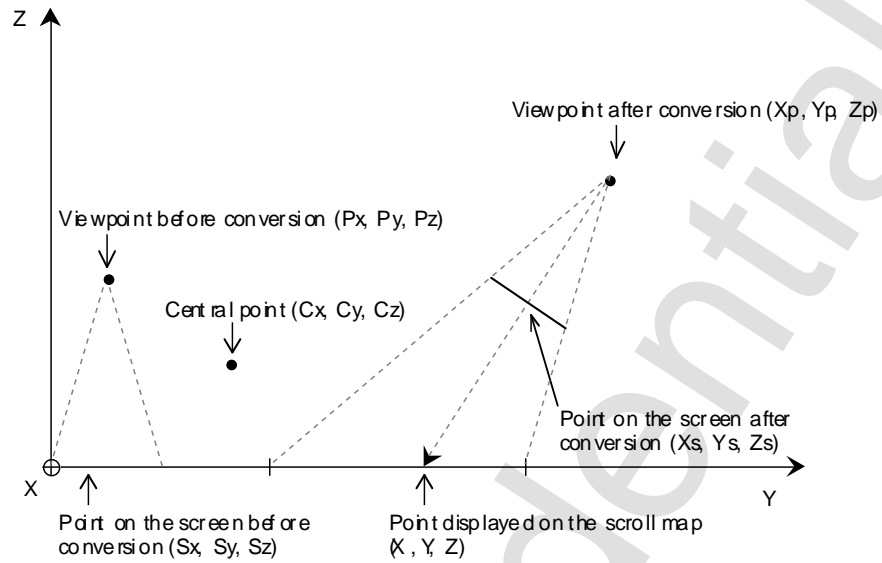

Note: X axis runs vertically through the page to the back.

**Figure 6.1 Rotation scroll screen display method**

From the rotation conversion formula, view coordinates and TV screen coordinates after conversion are expressed by the following equations.

$$\begin{pmatrix} X_p \\ Y_p \\ Z_p \end{pmatrix} = \begin{pmatrix} A & B & C \\ D & E & F \\ G & H & I \end{pmatrix} \begin{pmatrix} P_x - C_x \\ P_y - C_y \\ P_z - C_z \end{pmatrix} + \begin{pmatrix} C_x \\ C_y \\ C_z \end{pmatrix} + \begin{pmatrix} M_x \\ M_y \\ M_z \end{pmatrix}$$

$$\begin{pmatrix} X_s \\ Y_s \\ Z_s \end{pmatrix} = \begin{pmatrix} A & B & C \\ D & E & F \\ G & H & I \end{pmatrix} \begin{pmatrix} S_x - C_x \\ S_y - C_y \\ S_z - C_z \end{pmatrix} + \begin{pmatrix} C_x \\ C_y \\ C_z \end{pmatrix} + \begin{pmatrix} M_x \\ M_y \\ M_z \end{pmatrix}$$

- A, B, C, D, E, F, G, H, I: Rotational matrix parameter
- Px, Py, Pz: View coordinate before rotational conversion
- Sx, Sy, Sz: TV screen coordinates before rotational conversion
- Cx, Cy, Cz: Rotational center coordinate
- Mx, My, Mz: Amount of parallel movement
- Xp, Yp, Zp: View coordinate after rotational conversion
- Xs, Ys, Zs: TV screen coordinates after rotational conversion

The line of vision that passes through the TV screen after rotational conversion, from the viewpoint after rotational conversion, is expressed by the equation below.

$$\frac{X - X_p}{X_s - X_p} = \frac{Y - Y_p}{Y_s - Y_p} = \frac{Z - Z_p}{Z_s - Z_p}$$

Because the scroll map is fixed by the XY plane ( $Z = 0$ ), display coordinates ( $X, Y$ ) on the scroll map are found by the equation below.

$$\begin{aligned} X &= k(X_s - X_p) + X_p \\ Y &= k(Y_s - Y_p) + Y_p \end{aligned}$$

However,

$$k = \frac{-Z_p}{Z_s - Z_p}$$

This “k”, called the perspective conversion coefficient, rotates only in the vertical direction of the TV screen along the X axis rotation and is fixed in the horizontal direction. Furthermore, the Y axis rotation only changes in the horizontal direction of the TV screen, and is fixed in the vertical direction. Z axis rotation is always fixed.

Because the screen prior to rotational conversion is normally identical to the TV screen,  $S_x$  is the horizontal coordinate value (H counter value) in the TV screen,  $S_y$  is the vertical coordinate value (V counter value) in the TV screen, and  $S_z$  is 0. The screen coordinate value when the screen rotates in the vertical axis (SZ axis) is found by the equations below.

$$\begin{pmatrix} S_x \\ S_y \\ S_z \end{pmatrix} = \begin{pmatrix} a & b & 0 \\ c & d & 0 \\ 0 & 0 & 1 \end{pmatrix} \begin{pmatrix} H_{cnt} - C_{sx} \\ V_{cnt} - C_{sy} \\ 0 \end{pmatrix} + \begin{pmatrix} C_{sx} \\ C_{sy} \\ 0 \end{pmatrix} + \begin{pmatrix} M_{sx} \\ M_{sy} \\ M_{sz} \end{pmatrix}$$

a, b, c, d: TV screen rotation matrix parameter  
 Hcnt, Vcnt: HV counter value  
 Csx, Csy: TV screen rotation center coordinate  
 Msx, Msy, Msz: TV screen parallel movement amount

The previously mentioned expression is as shown below.

$$\begin{aligned} S_x &= X_{st} + DX \cdot H_{cnt} + DX_{st} \cdot V_{cnt} \\ S_y &= Y_{st} + DY \cdot H_{cnt} + DY_{st} \cdot V_{cnt} \\ S_z &= Z_{st} \end{aligned}$$

However,  $X_{st} = -a \cdot C_{sx} - b \cdot C_{sy} + C_{sx} + M_{sx}$   
 $Y_{st} = -c \cdot C_{sx} - d \cdot C_{sy} + C_{sy} + M_{sy}$



$$\begin{aligned} Z_{st} &= M_{sz} \\ \Delta X &= a \\ \Delta Y &= c \\ \Delta X_{st} &= b \\ \Delta Y_{st} &= d \end{aligned}$$

$X_{st}, Y_{st}, Z_{st}$ : TV screen start coordinate  
 $\Delta X, \Delta Y$ : TV screen horizontal coordinate increment  
 $\Delta X_{st}, \Delta Y_{st}$ : TV screen vertical coordinate increment

Below are the calculation equations of the display coordinates (X, Y) when performing both TV screen 3 axis rotation and TV screen rotation from the equations above.

$$\begin{aligned} X &= k_x (X_{sp} + dX \cdot H_{cnt}) + X_p \\ Y &= k_y (Y_{sp} + dY \cdot H_{cnt}) + Y_p \end{aligned}$$

However,

$$\begin{aligned} X_{sp} &= A\{(X_{st} + \Delta X_{st} \cdot V_{cnt}) - P_x\} + B\{(Y_{st} + \Delta Y_{st} \cdot V_{cnt}) - P_y\} + C\{Z_{st} - P_z\} \\ Y_{sp} &= D\{(X_{st} + \Delta X_{st} \cdot V_{cnt}) - P_x\} + E\{(Y_{st} + \Delta Y_{st} \cdot V_{cnt}) - P_y\} + F\{Z_{st} - P_z\} \\ X_p &= A(P_x - C_x) + B(P_y - C_y) + C(P_z - C_z) + C_x + M_x \\ Y_p &= D(P_x - C_x) + E(P_y - C_y) + F(P_z - C_z) + C_y + M_y \\ dX &= A \cdot \Delta X + B \cdot \Delta Y \\ dY &= D \cdot \Delta X + E \cdot \Delta Y \end{aligned}$$

$X_{st}, Y_{st}, Z_{st}$ : TV screen start coordinates  
 $\Delta X_{st}, \Delta Y_{st}$ : TV screen vertical coordinate increments  
 $\Delta X, \Delta Y$ : TV screen horizontal coordinate increments  
 A, B, C, D, E, F: Rotational matrix parameter  
 $P_x, P_y, P_z$ : View coordinates  
 $C_x, C_y, C_z$ : Center coordinates  
 $M_x, M_y$ : Amount of parallel movement  
 $k_x, k_y$ : Expansion reduction coefficient  
 $H_{cnt}, V_{cnt}$ : HV counter value

VDP2 reads per line all parameters from the rotation parameter table stored on VRAM, calculates  $X_{sp}, Y_{sp}, X_p, Y_p, dX, dY$  used for the above calculation equation, and uses these results to find the display coordinates (X, Y) of each dot. Expansion reduction coefficients  $k_x$  and  $k_y$  usually use values read from the rotational parameter table. By using the coefficient table, values in all lines and dots can be changed.

## 6.2 Rotation Scroll Screen Display Control

The rotation scroll screen has two surfaces, RBG0 and RBG1. When RBG1 is displayed, RBG0 must also be displayed (RBG0 appears when only one surface is displayed.) The Normal scroll screens can no longer be displayed at that time.

The image data (pattern name table or bitmap pattern) being displayed in the rotation scroll screen cannot be with image data of the Normal scroll screen; neither can image data of RBG0 and RBG1 be used in common. Furthermore, image data of the rotation scroll screen must be stored in separate VRAM. Among image data, the RBG1 pattern name table is stored in VRAM-B1, and character pattern table is stored in VRAM-B0.

When RBG0 needs coefficient only data with lines, the coefficient table can be stored in any VRAM bank. Image data must be stored in different banks when required with dots.

The register that controls the display of the rotation scroll screen has a screen display enable register and RAM control register. The screen display enable register controls the screen display and transparency code. The register content is the same as the Normal scroll screen. See “4.1 Screen Display Control” for details.

### RAM Control Register

The RAM control register selects the VRAM bank partition, the objective for using the rotation scroll screen VRAM, and the color RAM mode. It is a read-write 16 bit register and is at address 18000EH. Because the value of the register is cleared to 0 after power on or reset, you must set the value.

	15	14	13	12	11	10	9	8
RAMCTL	CRKTE	~	CRMD1	CRMD0	~	~	VRBMD	VRAMD
18000EH	7	6	5	4	3	2	1	0
	RDBSB11	RDBSB10	RDBSB01	RDBSB00	RDBSA11	RDBSA10	RDBSA01	RDBSA00

### Color RAM Coefficient Table Enable bit (CRKTE)

See “6.4 Coefficient Table Control.”



**Color RAM mode bit (CRMD1, CRMD0)**

See "3.4 Color RAM mode."

Set the Color RAM mode to mode 1 when the CRKTE bit is 1. At that time, color data can no longer be stored because the second half of the color RAM (100800H ~ 100FFFH) is used for the coefficient table data.

**VRAM mode bit (VRAMD, VRBMD)**

See "3.2 VRAM Bank Partition."

**Rotation data bank select bit: Data bank select bit (RDBSA01, RDBSA00, RDBSA11, RDBSA10, RDBSB01, RDBSB00, RDBSB11, RDBSB10)**

Designates the use objective of the VRAM of the rotation scroll screen. This bit is only in effect when the rotation scroll screen is displayed.

RDBSA00, RDBSA01	18000EH	Bit 1,0	For VRAM-A0 (or VRAM-A)
RDBSA10, RDBSA11	18000EH	Bit 3,2	For VRAM-A1
RDBSB00, RDBSB01	18000EH	Bit 5,4	For VRAM-B0 (or VRAM-B)
RDBSB10, RDBSB11	18000EH	Bit 7,6	For VRAM-B1

RDBSx1	RDBSx0	VRAM Use
0	0	Not used as RBG0 RAM
0	1	RAM for RBG0 End table
1	0	RAM for RBG0 Pattern Name table
1	1	RAM for RBG0 Character Pattern table (or Bitmap Pattern)

**Note:** A0, A1, B0, or B1 is entered in bit name for x.

When there are no bank partitions in VRAM, the VRAM-A0 bit is used for VRAM-A, and the VRAM-B0 bit is used for VRAM-B. When coefficient data is not treated as being needed in all dots, there is no need to set the coefficient table RAM (01B). When displaying by the bit map format, do not set the pattern name table RAM (10B). VRAM cycle pattern register settings of the VRAM bank selected in RAM used for the rotational scroll are ignored. Data will not be read out when there is no image data read-out address in the selected bank. Therefore, the correct screen can no longer be displayed.

When displaying RGB1, 00B must be set in bits used for VRAM-B0 and VRAM-B1. When the coefficient data read address is not the address within the selected bank, the coefficient data can not be read properly and therefore correct screen image can not be displayed. In addition, when storing the coefficient table in the color RAM, RGB0 coefficient table RAM (01B) must not be set.

SEGA Confidential





### 6.3 Rotation Parameter Control

When displaying the rotation scroll screen, be sure to store the rotation parameter on which control is performed as a table in VRAM. The rotation scroll screen reads the rotation parameter tables stored in VRAM for each line. The screen is displayed according to that value. The rotation parameter is shown below.

**Table 6.2 Rotation Parameters**

Rotation Parameter		Definition
Screen Start Coordinate	Xst	Screen upper left corner (or left edge) X coordinate
	Yst	Screen upper left corner (or left edge) Y coordinate
	Zst	Screen upper left corner (or left edge) Z coordinate
Screen Vertical Coordinate Increments	$\Delta Xst$	Screen coordinates X increment per each line
	$\Delta Yst$	Screen coordinates Y increment per each line
Screen Horizontal Coordinate Increments	$\Delta X$	Screen coordinates X increment per each dot
	$\Delta Y$	Screen coordinates Y increment per each dot
Rotation Matrix Parameter	A B C D E F	These parameters are include in 3X3 rotation matrix. $\begin{pmatrix} A & B & C \\ D & E & F \\ G & H & I \end{pmatrix}$
Viewpoint Coordinates	Px	Viewpoint X coordinate
	Py	Viewpoint Y coordinate
	Pz	Viewpoint Z coordinate
Center Coordinates	Cx	Center X coordinate
	Cy	Center Y coordinate
	Cz	Center Z coordinate
Amount of Horizontal Shift	Mx	Shift in X direction for screen, viewpoint, and center
	My	Shift in Y direction for screen, viewpoint, and center
Scaling Coefficients	kx	Scale coefficient of display screen in X direction
	ky	Scale coefficient of display screen in Y direction
Coefficient Table Start Address	KAst	Table start address when using coefficients table
Coefficient Table Vertical Address Increment	$\Delta KAst$	Address increment per each line when using coefficients table
Coefficient Table Horizontal Address Increment	$\Delta KAx$	Address increment when using coefficients table per each dot

**Note:** \* denotes when reading to each line.

Only Xst, Yst, and KAst among rotation parameters can be read by the first line of the display screen. The value of Xst, Yst, and KAst (when ΔXst, ΔYst, ΔX, ΔY, ΔKAst, and ΔKAx don't change inside one screen) are expressed by the equation below.

$$\begin{aligned} & \text{(Screen X coordinate)} \\ & = Xst + \Delta Xst \times (\text{V counter value}) + \Delta X \times (\text{H counter value}) \end{aligned}$$

$$\begin{aligned} & \text{(Screen Y coordinate)} \\ & = Yst + \Delta Yst \times (\text{V counter value}) + \Delta Y \times (\text{H counter value}) \end{aligned}$$

$$\begin{aligned} & \text{(coefficient table address)} \\ & = KAst + \Delta KAst \times (\text{V counter value}) + \Delta KAx \times (\text{H counter value}) \end{aligned}$$

Moreover, the first line can be read (in addition to Xst, Yst, and KAst) by setting the rotation parameter read control register. Values on and after the second lines of Xst, Yst, and KAst (when ΔXst, ΔYst, ΔX, ΔY, ΔKAst, and ΔKAx do not change within screen one) are expressed by the equation below.

$$\begin{aligned} & \text{(Screen X coordinate)} \\ & = Xst \\ & + \Delta Xst \times \{(\text{V counter value}) - (\text{V counter value when Xst is read out})\} \\ & + \Delta X \times (\text{H counter value}) \end{aligned}$$

$$\begin{aligned} & \text{(Screen Y coordinate)} \\ & = Yst \\ & + \Delta Yst \times \{(\text{V counter value}) - (\text{V counter value when Yst is read out})\} \\ & + \Delta Y \times (\text{H counter value}) \end{aligned}$$

$$\begin{aligned} & \text{(coefficient table address)} \\ & = KAst \\ & + \Delta KAst \times \{(\text{V counter value}) - (\text{V counter value when KAst is read out})\} \\ & + \Delta KAx \times (\text{H counter value}) \end{aligned}$$

The rotation scroll screen has two sets of parameter tables, called "Rotation Parameter A" and "Rotation Parameter B." The display screen of RBG1 is carried out by rotation parameter B. RBG0 selects which of the two sets of parameter tables is used, and can change within the display screen. Through this, RBG0 can simultaneously display two different rotation scroll screens on one screen.



In addition, the rotation parameter table moves by storing rotation parameter tables using RGB0 and RGB1, and does not always have to store two sets of rotation parameter tables.

### Data Configuration of the Rotation Parameter Table

Figure 6.2 shows various bit configurations of rotation parameters. Negative numbers indicate by two complements. The shaded part of the bit is ignored.

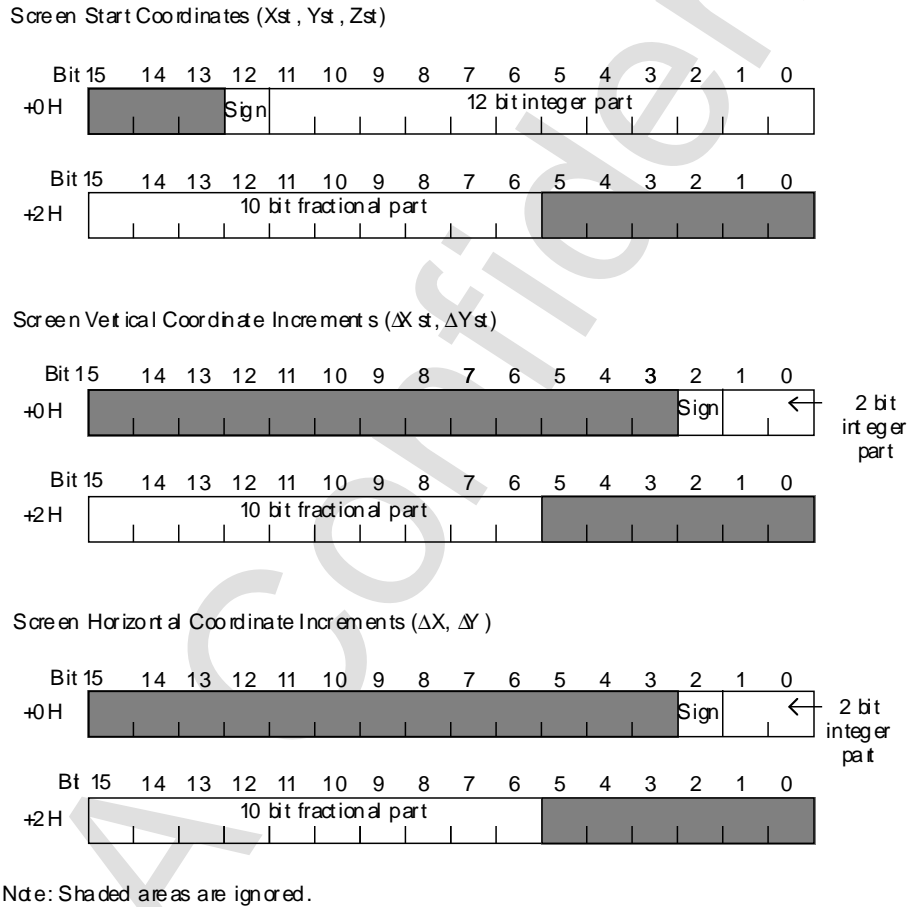
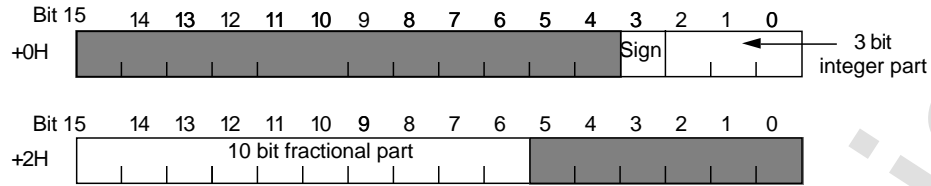
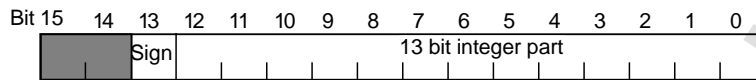

Figure 6.2 Rotation parameter data configuration

Rotation Matrix Parameter (A, B, C, D, E, F)



Viewpoint Coordinates (Px, Py, Pz)



Center Coordinates (Cx, Cy, Cz)

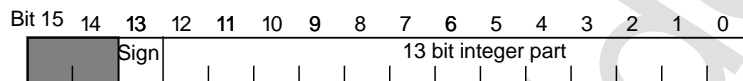

Amount of horizontal shift (Mx, My)

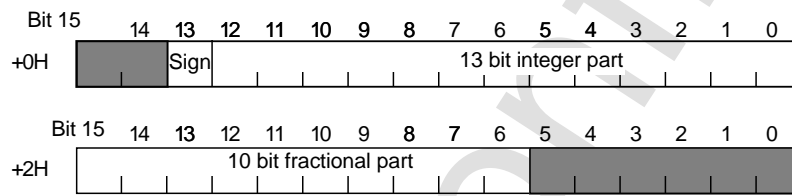

Scaling Coefficients (kx, ky)

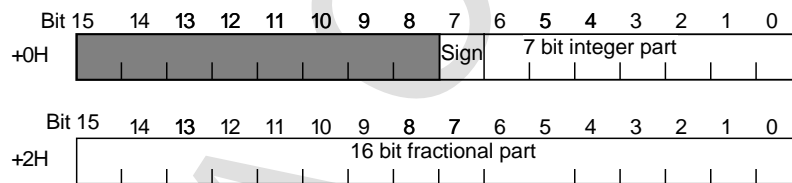

Coefficient Table Start Address (KAst)

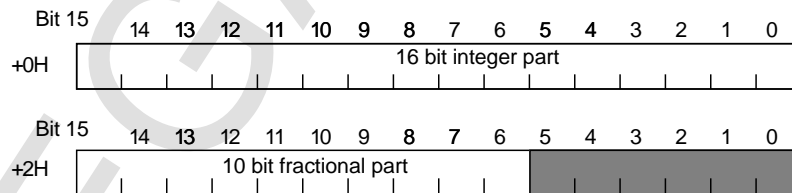

Note: Shaded areas are ignored.

Figure 6.2 Rotation parameter data configuration (continued)



Coefficient table vertical address increment ( $\Delta KA_{st}$ )

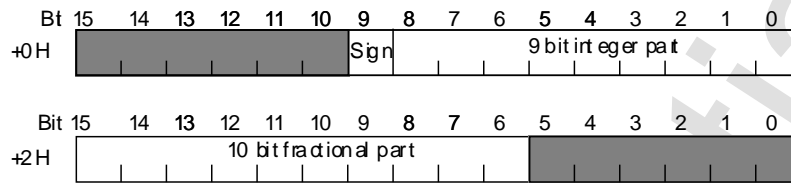

Coefficient table horizontal address increment ( $\Delta KA_x$ )

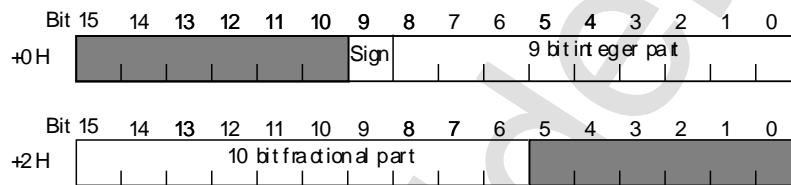

Note: Shaded areas are ignored

Figure 6.2 Rotation parameter data configuration (continued)

### Rotation Parameter Table

One set of rotation parameter tables at a size of 60H is stored in VRAM. Figure 6.3 shows the configuration of one set of tables.

+00H	Screen Start Coordinate Xst	(Integer Part)
+02H		(Fractional Part)
+04H	Screen Start Coordinate Yst	(Integer Part)
+06H		(Fractional Part)
+08H	Screen Start Coordinate Zst	(Integer Part)
+0AH		(Fractional Part)
+0CH	Screen Vertical Coordinate Increment $\Delta X_{st}$	(Integer Part)
+0EH		(Fractional Part)
+10H	Screen Vertical Coordinate Increment $\Delta Y_{st}$	(Integer Part)
+12H		(Fractional Part)
+14H	Screen Horiz. Coordinate Increment $\Delta X$	(Integer Part)
+16H		(Fractional Part)
+18H	Screen Horiz. Coordinate Increment $\Delta Y$	(Integer Part)
+1AH		(Fractional Part)
+1CH	Rotation Matrix Parameter A	(Integer Part)
+1EH		(Fractional Part)
+20H	Rotation Matrix Parameter B	(Integer Part)
+22H		(Fractional Part)
+24H	Rotation Matrix Parameter C	(Integer Part)
+26H		(Fractional Part)
+28H	Rotation Matrix Parameter D	(Integer Part)
+2AH		(Fractional Part)
+2CH	Rotation Matrix Parameter E	(Integer Part)
+2EH		(Fractional Part)
+30H	Rotation Matrix Parameter F	(Integer Part)
+32H		(Fractional Part)
+34H	Viewpoint Coordinate Px	(Integer Part)
+36H	Viewpoint Coordinate Py	(Integer Part)
+38H	Viewpoint Coordinate Pz	(Integer Part)
+3AH	This data is ignored	
+3CH	Center Point Coordinate Cx	(Integer Part)
+3EH	Center Point Coordinate Cy	(Integer Part)
+40H	Center Point Coordinate Cz	(Integer Part)
+42H	This data is ignored	
+44H	Horizontal Shift Mx	(Integer Part)
+46H		(Fractional Part)
+48H	Horizontal Shift My	(Integer Part)
+4AH		(Fractional Part)
+4CH	Scaling Coefficient kx	(Integer Part)
+4EH		(Fractional Part)
+50H	Scaling Coefficient ky	(Integer Part)
+52H		(Fractional Part)
+54H	Coefficient Table Start Address KAst	(Integer Part)
+56H		(Fractional Part)
+58H	Coefficient Table Vertical Address Increment $\Delta K_{Ast}$	(Integer Part)
+5AH		(Fractional Part)
+5CH	Coefficient Table Horiz. Address Increment $\Delta K_{Ax}$	(Integer Part)
+5EH		(Fractional Part)

Figure 6.3 Rotation parameter table



When storing two sets of tables of rotation parameter A and rotation parameter B, store the rotation parameter A from the lead address of the rotation parameter table, then enter the 20H part of invalid data and store tables of rotation parameter B. The rotation parameter table does not always have to store two sets, but can store only the tables needed. Figure 6.4 shows the method of storing two sets of tables from rotation parameters A and B.

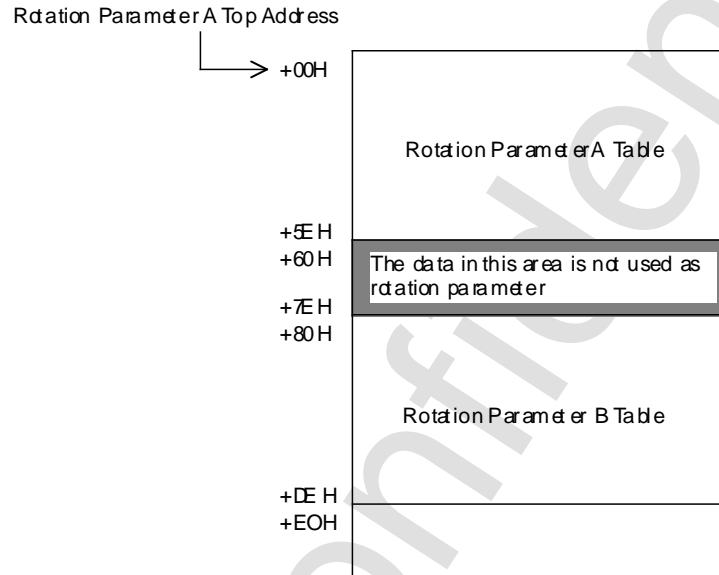

Figure 6.4 How to store to the rotation parameter table VRAM

### Rotation Parameter Read Control Register

The rotation parameter read control register is a write-only 16 bit register that indicates whether to read Xst, Yst, and KAst in each line, and is at address 1800B2H. Because the value is cleared to 0, it must be set after power on or reset.

	15	14	13	12	11	10	9	8
RPRCTL	~	~	~	~	~	RBKASTRE	RBYSTRE	RBXSTRE
1800B2H	7	6	5	4	3	2	1	0
	~	~	~	~	~	RAKASTRE	RAYSTRE	RAXSTRE

**Parameter read enable bit (RAXSTRE, RBXSTRE, RAYSTRE, RBYSTRE, RAKASTRE, RBKASTRE)**

Designates the coefficient table start address KAst and TV screen start coordinates Xst and Yst, and whether to read from the rotation parameter table in that line.

RAXSTRE	1800B2H	Bit 0	For Xst of Rotation Parameter A
RBXSTRE	1800B2H	Bit 8	For Xst of Rotation Parameter B
RAYSTRE	1800B2H	Bit 1	For Yst of Rotation Parameter A
RBYSTRE	1800B2H	Bit 9	For Yst of Rotation Parameter B
RAKASTRE	1800B2H	Bit 2	For KAst of Rotation Parameter A
RBKASTRE	1800B2H	Bit 10	For KAst of Rotation Parameter B

RxSTRE	Process
0	Selected parameters are not read for that line
1	Selected parameters are read for that line

**Note:** AX, BX, AY, BY, AKA, or BKA is entered in bit name for x.

If this bit is 1, selected parameters are read when the next rotation parameters are read. At the same time, this bit is cleared to 0. Therefore, to read parameters for each 1 line, this bit must be set to 1 for each line.

**Rotation Parameter Table Address Register**

The rotation parameter table address register is a write-only 16-bit register that selects the lead address of the rotation parameter table, and is at address 1800BCH to 1800BEH. Because the value is cleared to 0, it must be set after power on or reset.

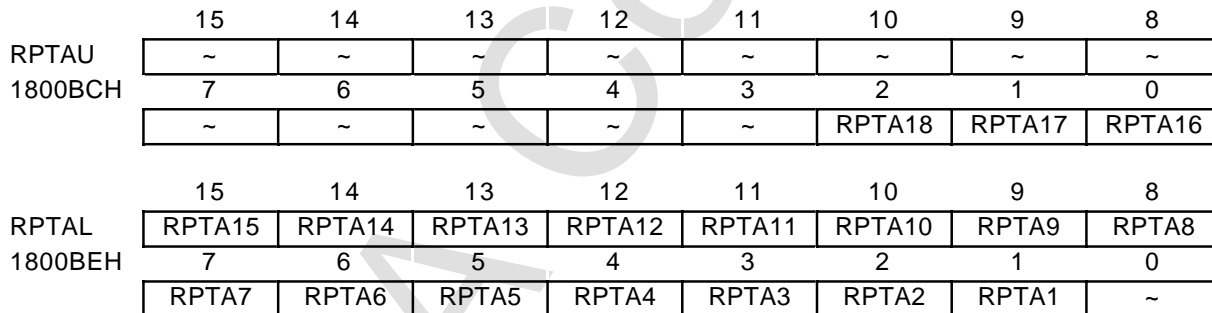



### Rotation parameters table address bit (RPTA8 to RPTA1)

Designates the lead address of rotation parameter tables.

RPTA18~RPTA16	1800BCH	Bit 2~0	
RPTA15~RPTA1	1800BEH	Bit 15~1	

RPTA6 bit is ignored even if data is written. The bit is set at 0 for rotation parameter A, and fixed at 1 for rotation parameter B.

The actual lead address of a rotation parameter table is calculated as shown in the equation below. When the VRAM size is 4 Mbit, the most significant bit of the address is ignored.

(Lead address of rotation parameter A)

$$\begin{aligned} &= (\text{rotation parameter table address register value highest 12 bit}) \times 100\text{H} \\ &+ (\text{rotation parameter table address register value lowest 5 bit}) \times 4\text{H} \end{aligned}$$

(Lead address of rotation parameter B)

$$\begin{aligned} &= (\text{rotation parameter table address register value highest 12 bit}) \times 100\text{H} \\ &+ (\text{rotation parameter table address register value lowest 5 bit}) \times 4\text{H} + 80\text{H} \end{aligned}$$

For example, when 00170H or 00130H is selected, the lead address of rotation parameter A is 00260H, and the lead address of rotation parameter B is 002E0H.

### Rotation Read Out of the Frame Buffer

Rotation reading of the frame buffer is executed using the TV screen start coordinates (Xst, Yst) of rotation parameter A, TV screen vertical coordinate increments ( $\Delta X_{st}$ ,  $\Delta Y_{st}$ ), and TV screen horizontal coordinate increments ( $\Delta X$ ,  $\Delta Y$ ). If the image selected by rotation parameter A in the rotation scroll screen is to be displayed, the entire sprite and rotation scroll screen can be made to rotate identically. If the image selected by rotation parameter B in the rotation scroll screen is to be displayed, the entire sprite and rotation scroll screen can be made to rotate separately.

The frame buffer display coordinate value calculates from the TV screen starting coordinate, the display coordinate of the left end of the line calculated in each line from the TV screens vertical coordinate increment and horizontal coordinate. The bit will be discarded and calculated from the coordinate range of the frame buffer so that the display coordinate value of the line's left end is calculated in 20 bits (code+integer10-bit +decimal part 9-bit), and the horizontal coordinate increment in a total of 12 bits (code+integer part 2-bit+decimal part 9-bit).

**Note:** In order to read frame buffer rotation using rotation parameter A, VDP1 TV mode must be set to rotation 16 or rotation 8. For details, please refer to VDP1 user manual.

## Rotation Parameter Change

RBG0 indicates which of two sets of rotation parameter tables is used, and can change in part the rotation parameter on one screen display. The method of using the rotation parameter can be selected from the four rotation parameter modes below.

- Mode 0: Uses rotation parameter A
- Mode 1: Uses rotation parameter B
- Mode 2: Changes the image by coefficient data read from the coefficient table of rotation parameter A
- Mode 3: Changes by the rotation parameter window.

Modes 0 and 1 display the image obtained through each rotation parameter table set. Modes 2 and 3 display the images within one screen obtained through rotation parameters A and B.

Set Mode 2 to use the coefficient table of rotation parameter A by setting the RAKTE bit of the coefficient table control register to 1. The value of the most significant bit of coefficient data read from the coefficient table displays the image obtained by rotation parameter A when it is 0, but displays the image obtained by rotation parameter B as an RBG0 image when it is 1. When set to read coefficient data used for rotation parameter A in each dot, two images can also be changed in each dot, but coefficient data used for rotation parameter B cannot be read in each dot.

Mode 3 changes two images according to the bit used in the rotation parameter window of the rotation window control register. When the window is used as the transparent process window, the part of the screen that is cut off and made transparent displays the image obtained by rotation parameter B; the remaining part is displayed as an RBG0 image obtained by rotation parameter A.



An example of image display from above modes 0 to 3 is shown in Figure 6.5.

When Rotation Parameter Mode 0

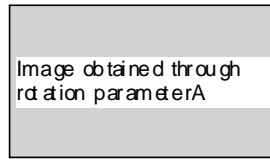

When Rotation Parameter Mode 1

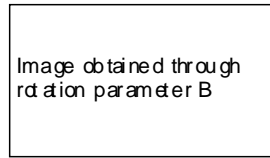

When Rotation Parameter Mode 2

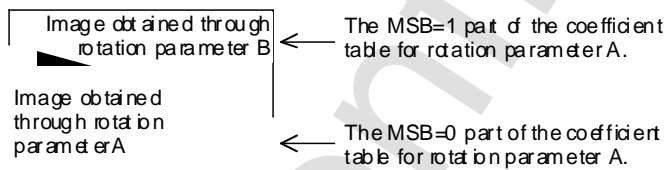

Rotation Parameter Mode 3 Switched through Rotation Parameter Window and displayed

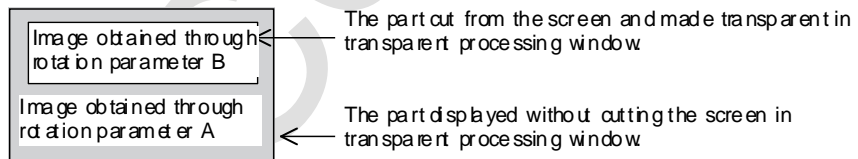

Figure 6.5 Rotation parameter change

## Rotation Parameter Mode Register

The rotation parameter mode register is a write-only 16 bit register that controls rotation parameter tables used in RGB0, and is at address 1800B0H. Because the value is cleared to 0, it must be set after power on or reset.

	15	14	13	12	11	10	9	8
RPMD	~	~	~	~	~	~	~	~
1800B0H	7	6	5	4	3	2	1	0
	~	~	~	~	~	~	RPMD1	RPMD0

### Rotation parameters mode bit (RPMD1, RPMD0), bits 1 and 0

When displaying RGB0, designates which rotation parameter of A or B will be used.

RPMD1	RPMD0	Mode	Rotation Parameter
0	0	0	Rotation Parameter A
0	1	1	Rotation Parameter B
1	0	2	A screen and B screen are switched via coefficient data read from rotation parameter A coefficient table.
1	1	3	A screen and B screen are switched via rotation parameter window

The value of this bit is always in effect, therefore, be careful in timing reloading.

When mode 2 is selected, coefficient data cannot be read to each dot from the coefficient table for rotation parameter B while coefficient data for rotation parameter A is being read to each dot. Therefore, the designation is ignored even if a register is designated so that coefficient data is read to each dot from the coefficient table used for rotation parameter B.

In mode 3, coefficient data can be read to each dot in both coefficient tables for rotation parameter A and B.

Mode 0 must be set when displaying RGB1.



## 6.4 Coefficient Table Control

The rotation scroll screen stores parameters used in calculating display coordinates in VRAM or color RAM in a table separate from the rotation parameter table, and can express various images by reading parameters per line or per dot. This table is referred to as “coefficient table.”

The timing required for the coefficient table data, depending on how display coordinates are calculated, falls under the following cases:

1. Required per line
2. Required per dot

When coefficient table data is required per line, the coefficient table must be stored in VRAM. The VRAM address to read the stored coefficient table data is specified via  $K_{Ast}$ ,  $\Delta K_{Ast}$ , and  $\Delta K_{Ax}$  in rotation parameter table and coefficient table address offset register.

When coefficient table data is required per dot, the coefficient table must be stored in either VRAM or color VRAM. When stored in VRAM, at least 1 bank in RAM control register “rotation data bank selection” must be selected to become coefficient table. The VRAM address to read the stored coefficient table data is specified via  $K_{Ast}$ ,  $\Delta K_{Ast}$ , and  $\Delta K_{Ax}$  in rotation parameter table and coefficient table address offset register. Also, when storing coefficient table in color RAM, it should be stored in the latter half of color RAM (100800H to 100FFFH). The color RAM address to read the stored coefficient table data is specified via  $K_{Ast}$ ,  $\Delta K_{Ast}$ , and  $\Delta K_{Ax}$  in rotation parameter table. As for the address to read coefficient table data, only the lower 10 bits in the integer part of the calculated coefficient table address become valid.

To select parameters for which the data read from the coefficient table are to be used, the following 4 modes (coefficient data modes) are provided:

- Mode 0: Used as Scale coefficient  $k_x$  and  $k_y$
- Mode 1: Used as Scale coefficient  $k_x$
- Mode 2: Used as Scale coefficient  $k_y$
- Mode 3: Used as viewpoint coordinate  $X_p$  after rotation conversion

In mode 0,  $k_x$  and  $k_y$  read from the rotation parameter table become invalid; data read from the coefficient table is used as  $k_x$  and  $k_y$ .

When mode 1 is selected,  $k_y$  read from the rotation parameter table is used, but data read from the coefficient table is used for  $k_x$ .

When mode 2 is selected,  $k_x$  read from the rotation parameter table is used, but data read from the coefficient table is used for  $k_y$ .

When mode 3 is selected, X direction viewpoint coordinate  $X_p$ , converted rotationally as data read from the rotation parameter table, becomes invalid. Data read from the coefficient table is used for  $X_p$ .

### Line Color Screen Data

Coefficient data can be used not only as rotation parameters, but as part of line color screen data. In this case, the highest 4-bit data read from the line color screen table is added to the highest of 7-bit data that is part of coefficient data. Figure 6.6 shows line color screen data using coefficient data.

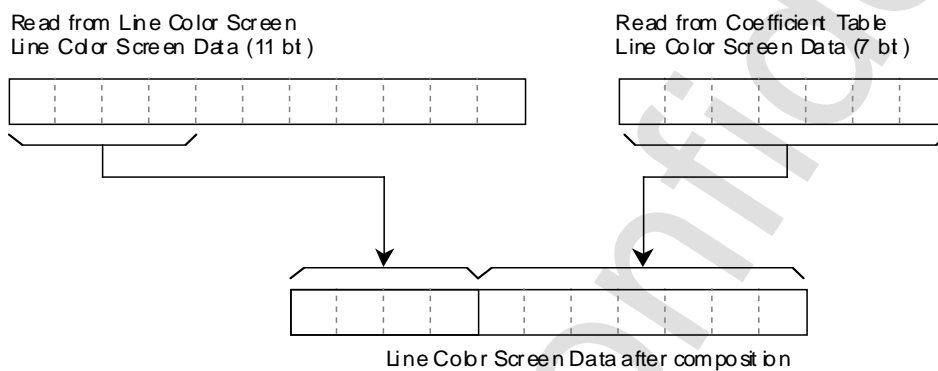

**Figure 6.6** Line color screen data using coefficient data

When specifying mode 0 for rotation parameter mode, line color screen per rotation parameter A coefficient table is used. When specifying mode 1, line color screen per rotation parameter B coefficient table is used.

When specifying mode 2, for both rotation parameter A graphics and rotation parameter B graphics, line color screen per rotation parameter A coefficient table is used.

When specifying mode 3, for rotation parameter A graphics, line color screen per rotation parameter A coefficient table is used, whereas for rotation parameter B graphics, line color screen per rotation parameter B coefficient table is used.

Also, when displaying RGB1, for both RGB0 and RGB1, line color screen per rotation parameter A coefficient table is used.



## Bit Configuration of Coefficient Table Data

Either "1-word" or "2-word" can be chosen as the data size on the coefficient table. The data configuration changes depending on this coefficient data size and coefficient data mode. Figure 6.7 shows the bit configuration of coefficient table data.

### Coefficient Data Mode 0-2

Coefficient Data Size: 2 words

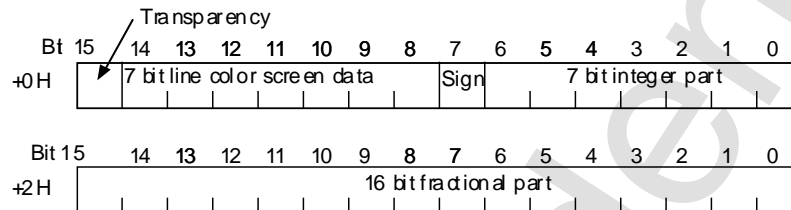

Coefficient Data Size: 1 word

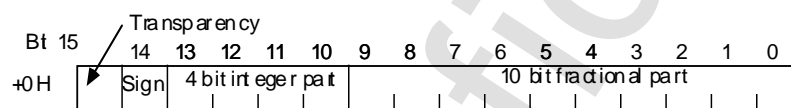

Note: The MSB are sign-expanded by 3 bits and the LSB are 0-expanded by 6 bits to be of equal to the number of bits as in the case of 2 words.

### Coefficient Data Mode 3

Coefficient Data Size: 2 words

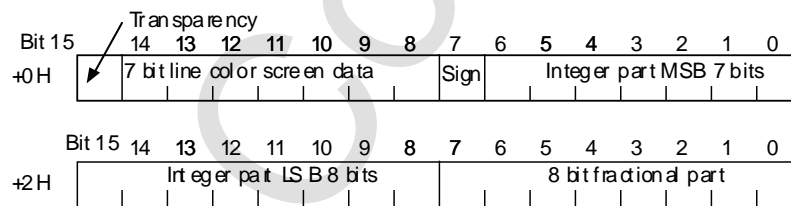

Coefficient Data Size: 1 word

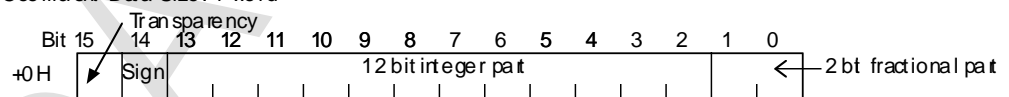

Note: The MSB are sign-expanded by 3 bits and the LSB are 0-expanded by 6 bits to be of equal to the number of bits as in the case of 2 words.

Figure 6.7 Bit configuration of coefficient table data

## Coefficient Table Lead Address

The coefficient table lead address is obtained from the coefficient table start address (KAst integer part 16-bit) read from the coefficient table address offset register and rotation parameter table. The coefficient table vertical address increment ( $\Delta$ KAst integer part 9-bit) and coefficient table horizontal address increment ( $\Delta$ KA integer part 9-bit) are also read from the rotation parameter table.

The address value of the address offset, start address and address increment change according to the data size of the coefficient table. Table 6.3 shows the address value showing the least significant bit of each value. For example, when 4H is 2-word (the least significant bit of integer KAst signifies the expression of the 4H address value), it can be calculated as shown below.

$$(\text{Coefficient table start address}) = (\text{KAst integer part 16 bit}) \times 4\text{H}$$

**Table 6.3** Address values shown by the least significant bits of coefficient parameter data of separate coefficient data sizes

Coefficient Data Size	Address Value Indicated by the LSB	
	Coefficient Table Address Offset Register Value	KAst, $\Delta$ KAst, $\Delta$ KAx Integer part value
2 Words	40000H	4H
1 Word	20000H	2H

## Most Significant Bit of Coefficient Data

The most significant bit of coefficient data is usually used as transparent bits; dots that used coefficient data in which this bit is 1 are forced to be transparent dots. However, when rotation parameter mode 2 is selected by RBG0, the most significant bit of data read from the coefficient table used for rotation parameter A is used for switching rotation parameters. When the most significant bit is 0, the designated image is displayed by rotation parameter A. When the most significant bit is 1, the designated image is displayed by rotation parameter B. Here, the most significant bit of coefficient data read from the coefficient table used for rotation parameter B is used as a transparent bit. The most significant bit of coefficient data for RBG1 is always used as a transparent bit. Table 6.4 shows image processing by the most significant bit values of coefficient data.





**Table 6.4 Image processing using RBG0 coefficient data MSB value**

Rotation Parameter Mode	Rotation Parameter	MSB Function	MSB Value	Image Process
0	A	Transparent	0	Displays image obtained using the coefficient data
			1	Forces the dot to be transparent using the coefficient data
	B	Not Used	-	-
1	A	Not Used	-	-
	B	Transparent	0	Displays image obtained using the coefficient data
2	A	Parameter	0	Displays image obtained using the coefficient data
		Switching	1	Invalidates the coefficient data and displays image obtained using rotation parameter B
	B	Transparent	0	Displays image obtained using the coefficient data
			1	Forces the dot to be transparent using the coefficient data
			1	Forces the dot to be transparent using the coefficient data
3	A, B	Transparent	0	Displays image obtained using the coefficient data
			1	Forces the dot to be transparent using the coefficient data

### RAM Control Register

The RAM control register is a read/write 16-bit register that selects the VRAM bank partition, rotation scroll screen VRAM use, and color RAM mode. After power-on or reset, the value will be cleared and therefore must be set.

	15	14	13	12	11	10	9	8
RAMCTL	CRKTE	~	CRMD1	CRMD0	~	~	VRBMD	VRAMD
18000EH	7	6	5	4	3	2	1	0
	RDBSB11	RDBSB10	RDBSB01	RBBSB00	RDBSA11	RDBSA10	RDBSA01	RBBSA00

#### Color RAM Coefficient Table Enable (CRKTE), bit 15.

Selects whether to store the coefficient table in the color RAM.

CRKTE	Function
0	Coefficient table is stored in VRAM
1	Coefficient table is stored in color RAM

**Color RAM Mode Bit: (CRMD1, CRMD0), bits 13 and 12**

Please see color RAM mode in 3.4.

When CRKTE is set to 1, please set color RAM mode to 1. Here, the latter half of the color RAM (100800H-100FFFH) will be used for coefficient table data, therefore, the color data cannot be stored.

**VRAM Mode Bit: (VRAMD, VRBMD), bits 9 and 8**

Please see VRAM bank partition in 3.2.

**Rotation Data Bank Select Bit: (RDBSA00-11, RDBSB00-11), bits 7 through 0**

Please see rotation scroll display control in 6.2.

When CRKTE is set to 1, VRAM bank 4 may not be selected to be used as coefficient table data RAM.

**Coefficient Table Control Register**

The coefficient table control register is a write-only 16-bit register that controls the coefficient table, and is at address 1800B4H. Because the value is cleared to 0, it must be set after power on or reset.

	15	14	13	12	11	10	9	8
KTCTL	~	~	~	RBKLCE	RBKMD1	RBKMD0	RBKDBS	RBKTE
1800B4H	7	6	5	4	3	2	1	0
	~	~	~	RAKLCE	RAKMD1	RAKMD0	RAKDBS	RAKTE

**Coefficient line color enable bit (RAKLCE, RBKLCE)**

Designates whether to use line color screen data in coefficient data.

RAKLCE	1800B4H	Bit 4	For Rotation Parameter A
RBKLCE	1800B4H	Bit 12	For Rotation Parameter B

This bit uses the corresponding coefficient table and is effective only when the data size is 2-word.

RxKLCE	Process
0	Line color screen data within coefficient data is not used
1	Line color screen data within coefficient data is used

**Note:** A or B is entered in the bit name for x.



**Coefficient data mode bit: Coefficient mode bit (RAKMD1, RAKMD0, RBKMD1, RBKMD0)**

Designates what parameters the coefficient data is used as.

RAKMD1, RAKMD0	1800B4H	Bit 3,2	For Rotation Parameter A
RBKMD1, RBKMD0	1800B4H	Bit 11,10	For Rotation Parameter B

Because this bit is always in effect, be careful in rewriting timing.

RxKMD1	RxKMD0	Mode	Coefficient Data Function
0	0	0	Use as scale coefficient kx, ky
0	1	1	Use as scale coefficient kx
1	0	2	Use as scale coefficient ky
1	1	3	Use as viewpoint Xp after rotation conversion

**Note:** A or B is entered in the bit name for x.

**Coefficient data size bit (RAKDBS, RBKDBS)**

Designates the size of the coefficient data.

RAKDBS	1800B4H	Bit 1	For Rotation Parameter A
RBKDBS	1800B4H	Bit 9	For Rotation Parameter B

This bit is in effect only when the corresponding coefficient table is used.

RxKDBS	Coefficient Data Size
0	2 Words
1	1 Word

**Note:** A or B is entered in the bit name for x.

**Coefficient table enable bit (RAKTE, RBKTE)**

Designates whether the coefficient table is used.

RAKTE	1800B4H	Bit 0	For Rotation Parameter A
RBKTE	1800B4H	Bit 8	For Rotation Parameter B

RxKTE	Process
0	Do not use coefficient table
1	Use coefficient table

**Note:** A or B is entered in the bit name for x.

## Coefficient Table Address Offset Register

Coefficient table address offset register is a write-only 16-bit register that designates the coefficient table lead address offset value, and is at address 1800B6H. Because the value is cleared to 0, it must be set after power on or reset.

	15	14	13	12	11	10	9	8
KTAOF	~	~	~	~	~	RBKTAOS2	RBKTAOS1	RBKTAOS0
1800B6H	7	6	5	4	3	2	1	0
	~	~	~	~	~	RAKTAOS2	RAKTAOS1	RAKTAOS0

### Coefficient table address offset bit (RAKTAOS2 to RAKTAOS0, RBKTAOS2 to RBKTAOS0)

Designates the lead address offset value of the coefficient table stored in the rotation parameter table.

RAKTAOS2~RAKTAOS0	1800B6H	Bit 2~0	For Rotation Parameter A
RBKTAOS2~RBKTAOS0	1800B6H	Bit 10~8	For Rotation Parameter B

These bits are added to the highest coefficient table start address (KAst) read from the rotation parameter table. The actual lead address of the coefficient table changes according to the size of the coefficient data, and is calculated by the expression below. When VRAM size is 4 Mbits, the most significant bit of the address is ignored.

When the coefficient data size is 2 word:

(coefficient table lead address)  
 = (coefficient table address offset register value lowest 2 bits)  
 X 40000H + (KAst integer part 16 bit) X 4H

When the coefficient data size is 1 word:

(coefficient table lead address)  
 = (coefficient table address offset register value 3 bits)  
 X 20000H + (KAst integer part 16 bit) X 2H



# Chapter 7 Line Screen

- Introduction ..... 172
- 7.1 Line Color Screen ..... 172
  - Line Color Screen Table Address Register ..... 174
- 7.2 Back Screen ..... 175
  - Back Screen Table Address Register ..... 176

## Introduction

There are two line screen surfaces: the line color screen (LNCL) and the back screen (BACK). The line screen designates the color in each line, or the entire screen in a single color. Unlike the scroll screen, the line screen cannot display characters. The line color screen stores the data of each line in VRAM as a line color screen table. If single colored, lead data of the table is used in the entire screen. The line screen is shown in Figure 7.1.

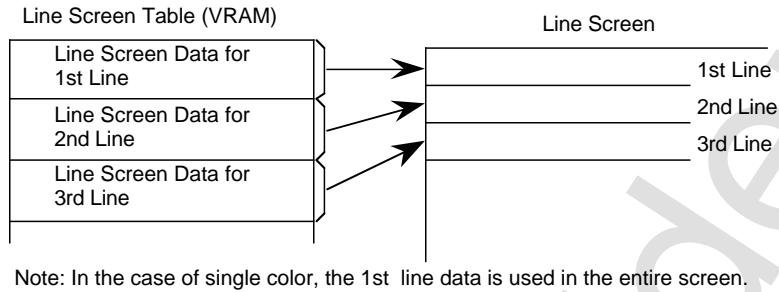

Figure 7.1 Line Screen

## 7.1 Line Color Screen

The line color screen is used only for color calculations, and chooses whether to designate the entire screen in a single color, or designate the color for each line. The color RAM address of the color used is stored in VRAM as line color screen data.

The line number designated by one line color screen data changes, depending on the interlace setting. The non-interlace and double-density interlace modes can designate the color for each line; the single-density interlace mode can designate for each two lines.

The line color screen can also be made to rotate if line color screen data is used within coefficient data. For more about coefficient data see section "6.4 Coefficient Table Control." Figure 7.2 shows the configuration of the line color screen table separate of the interlace mode. Figure 7.3 shows the configuration of data on the line color screen table.



Non-interlace and double-density interlace mode

Bit 15	Line Color Screen Table (VRAM)	0
+00H	1st Line Color RAM Address	
+02H	2nd Line Color RAM Address	
+04H	3rd Line Color RAM Address	
+06H	4th Line Color RAM Address	
+08H	5th Line Color RAM Address	
+0AH	6th Line Color RAM Address	

Note: In the case of single color, the first line color RAM address is used in the entire line color screen. In the case of double-density interlace, line data of odd and even fields are stored together.

Single-density interlace mode

Bit 15	Line Color Screen Table (VRAM)	0
+00H	1st and 2nd Line Color Ram Address	
+02H	3rd and 4th Line Color Ram Address	
+04H	5th and 6th Line Color Ram Address	
+06H	7th and 8th Line Color Ram Address	
+08H	9th and 10th Line Color Ram Address	
+0AH	11th and 12th Line Color Ram Address	

Note: In the case of single color, the first and second line color RAM addresses are used in the entire line color screen.

**Figure 7.2 Configuration of line color screen table**

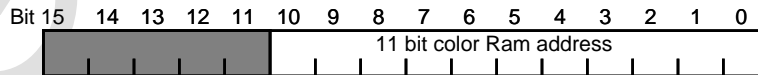

Note: Shaded areas are ignored. Also, when color RAM is in mode 0 or mode 2, the MSB of the address is ignored.

**Figure 7.3 Bit configuration of line color screen table data**

## Line Color Screen Table Address Register

The line color screen table address register is a 32-bit register, and designates the lead address of the table and the color mode of the line color screen. Its addresses are 1800A8H through 1800AAH. Because the value is cleared to 0, it must be set after power on, or reset.

	15	14	13	12	11	10	9	8
LCTAU	LCCLMD	~	~	~	~	~	~	~
1800A8H	7	6	5	4	3	2	1	0
	~	~	~	~	~	LCTA18	LCTA17	LCTA16
	15	14	13	12	11	10	9	8
LCTAL	LCTA15	LCTA14	LCTA13	LCTA12	LCTA11	LCTA10	LCTA9	LCTA8
1800AAH	7	6	5	4	3	2	1	0
	LCTA7	LCTA6	LCTA5	LCTA4	LCTA3	LCTA2	LCTA1	LCTA0

### Line color screen mode bit: LNCL color mode bit (LCCLMD), bit 15

Designates the color mode of the line color screen.

LCCLMD	Line Color Screen Color
0	Single color
1	Select per each line

### Line color screen table address bit: LNCL table address bit (LCTA18 to LCTA0)

Designates the lead address of the line color screen table on the VRAM.

LCTA18~LCTA16	1800A8H	Bit 2~0	
LCTA15~LCTA0	1800AAH	Bit 15~0	

The actual lead VRAM address is calculated by the expression below. When the VRAM size is 4 Mbits, the most significant bit of the address is ignored.

(Line color screen table lead address)

$$= (\text{Line color screen table address register value 19 bit}) \times 2\text{H}$$





## 7.2 Back Screen

The back screen (BACK) is displayed only when other screens aren't, and chooses whether to designate a single color for the entire screen or for each line. Color data used by a line is designated by each 5-bit RGB. The non-interlace and double-density interlace mode designates the color in each line, but the single-density interlace mode can designate only in each two lines. Figure 7.4 shows the configuration of the back screen table by the interlace mode. Figure 7.5 shows the configuration of data on the back screen table.

Non-interlace and double-density interlace mode

Bit 15	Back Screen Table (VRAM)	0
+00H	1st Line RGB Data	
+02H	2nd Line RGB Data	
+04H	3rd Line RGB Data	
+06H	4th Line RGB Data	
+08H	5th Line RGB Data	
+0AH	6th Line RGB Data	

Note: In the case of single color, the first line RGB data is used in the entire line color screen. In the case of double-density interlace, line data of odd and even field are stored together.

Single-density interlace mode

Bit 15	Back Screen Table (VRAM)	0
+00H	1st and 2nd Line RGB Data	
+02H	3rd and 4th Line RGB Data	
+04H	5th and 6th Line RGB Data	
+06H	7th and 8th Line RGB Data	
+08H	9th and 10th Line RGB Data	
+0AH	11th and 12th Line RGB Data	

Note: In the case of single color, the first and second line RGB data are used in the entire line color screen.

**Figure 7.4 Configuration of back screen table**

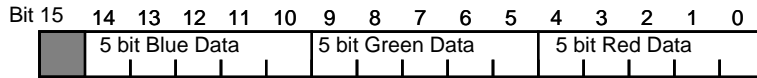

Note: Shaded area is ignored. Add 0 bit 3 bits at a time to the lower bits of RGB to make 8 bits.

**Figure 7.5 Bit configuration of back screen table data**

### Back Screen Table Address Register

Back screen table address register is a write-only 32-bit registers, and selects the back screen color mode and table lead address. Its addresses are 1800ACH through 1800AEH. Because the value is cleared to 0, it must be set after power on or reset.

	15	14	13	12	11	10	9	8
BKTAU	BKCLMD	~	~	~	~	~	~	~
1800ACH	7	6	5	4	3	2	1	0
	~	~	~	~	~	BKTA18	BKTA17	BKTA16

	15	14	13	12	11	10	9	8
BKTAL	BKTA15	BKTA14	BKTA13	BKTA12	BKTA11	BKTA10	BKTA9	BKTA8
1800AEH	7	6	5	4	3	2	1	0
	BKTA7	BKTA6	BKTA5	BKTA4	BKTA3	BKTA2	BKTA1	BKTA0

#### Back screen color mode bit: BACK color mode bit (BKCLMD), bit 15

Designates color mode of the back screen.

BKCLMD	Back Screen Color
0	Single color
1	Select per each line

#### Back screen table address bit: BACK color table address bit (BKTA18 to BKTA0)

Designates the lead address of the back screen table on the VRAM.

BKTA18~BKTA16	1800ACH	Bit 2~0	
BKTA 15~BKTA0	1800AEH	Bit 15~0	



The actual lead VRAM address is calculated by the expression below. When the VRAM capacity is 4 Mbits, the most significant bit of the address is ignored.

(Back screen table lead address)

$$= (\text{Back screen table address register value 19 bit}) \times 2H$$

When the back screen color mode bit is set to “single color”, color data selected by the back screen table address bit is used in the entire screen.

SEGA Confidential

(This page is blank in the original Japanese document)

SEGA Confidential



## Chapter 8 Windows

8.1	Window Area .....	180
	Normal Rectangular Window .....	180
	Window Position Register .....	181
	Normal Line Window .....	184
	Line Window Table Address Register .....	186
	Sprite Window .....	187
	Sprite Control Register .....	188
	Window Active Area in the Screen .....	189
8.2	Window Process .....	190
	Window Process Register .....	193

## 8.1 Window Area

The scroll IC window has two Normal windows, W0 and W1, and one sprite window, SW. The Normal window selects start and end coordinates on the TV screen; the sprite window designates the most significant bit value of sprite data written to the frame buffer. Various windows can designate which scroll screen is to be put into effect, and whether the inside or outside of the area will go into effect. Moreover, when more than one window is used, they can be overlapped other by AND or OR logic.

The Normal window selects the Normal rectangular window designated through the horizontal and vertical start and end coordinates, and selects the Normal line window designated through horizontal start and end coordinates in each line. The start and end coordinates set the coordinate values on the TV screen in each register, and not on the scroll screen.

### Normal Rectangular Window

The normal rectangular window is obtained by selecting the start coordinates in the upper left corner in the window position register, and the end coordinates in the lower right corner of the window. The area surrounded by selected coordinates is inside, the rest of area is outside. The border line of the window is considered part of the inside.

If the start coordinate of either the horizontal or vertical direction is larger than the end coordinate, then the whole screen is considered an area outside the window. Figure 8.1 shows the Normal rectangular window.

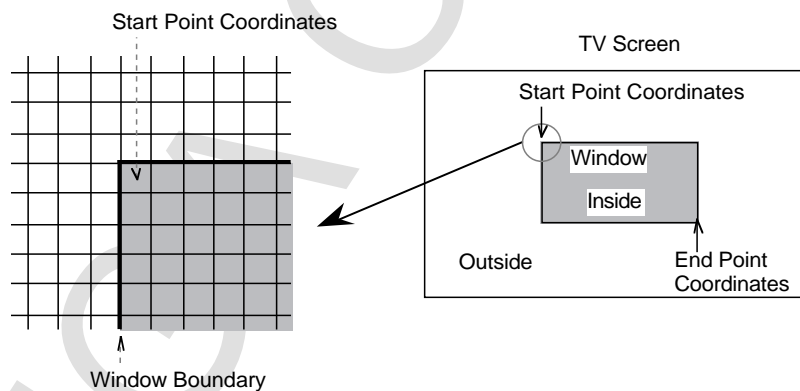

Figure 8.1 Normal rectangular window



## Window Position Register

The window position register is a write-only 16-bit register that selects the horizontal and vertical start and end coordinates of the Normal window, and is located from addresses 1800C0H through 1800CEH. Because the value is cleared to 0, it must be set after power on or reset.

	15	14	13	12	11	10	9	8
WPSX0	~	~	~	~	~	~	W0SX9	W0SX8
1800C0H	7	6	5	4	3	2	1	0
	W0SX7	W0SX6	W0SX5	W0SX4	W0SX3	W0SX2	W0SX1	W0SX0
	15	14	13	12	11	10	9	8
WPSY0	~	~	~	~	~	~	~	W0SY8
1800C2H	7	6	5	4	3	2	1	0
	W0SY7	W0SY6	W0SY5	W0SY4	W0SY3	W0SY2	W0SY1	W0SY0
	15	14	13	12	11	10	9	8
WPEX0	~	~	~	~	~	~	W0EX9	W0EX8
1800C4H	7	6	5	4	3	2	1	0
	W0EX7	W0EX6	W0EX5	W0EX4	W0EX3	W0EX2	W0EX1	W0EX0
	15	14	13	12	11	10	9	8
WPEY0	~	~	~	~	~	~	~	W0EY8
1800C6H	7	6	5	4	3	2	1	0
	W0EY7	W0EY6	W0EY5	W0EY4	W0EY3	W0EY2	W0EY1	W0EY0
	15	14	13	12	11	10	9	8
WPSX1	~	~	~	~	~	~	W1SX9	W1SX8
1800C8H	7	6	5	4	3	2	1	0
	W1SX7	W1SX6	W1SX5	W1SX4	W1SX3	W1SX2	W1SX1	W1SX0
	15	14	13	12	11	10	9	8
WPSY1	~	~	~	~	~	~	~	W1SY8
1800CAH	7	6	5	4	3	2	1	0
	W1SY7	W1SY6	W1SY5	W1SY4	W1SY3	W1SY2	W1SY1	W1SY0
	15	14	13	12	11	10	9	8
WPEX1	~	~	~	~	~	~	W1EX9	W1EX8
1800CCH	7	6	5	4	3	2	1	0
	W1EX7	W1EX6	W1EX5	W1EX4	W1EX3	W1EX2	W1EX1	W1EX0
	15	14	13	12	11	10	9	8
WPEY1	~	~	~	~	~	~	~	W1EY8
1800CEH	7	6	5	4	3	2	1	0
	W1EY7	W1EY6	W1EY5	W1EY4	W1EY3	W1EY2	W1EY1	W1EY0

**Window position bit (for horizontal coordinates): Window start/end X bit (W0SX9 to W0SX0, W0EX9 to W0EX0, W1SX9 to W1SX0, W1EX9 to W1EX0)**

Designates the horizontal start and end coordinates. Designated coordinate value is the coordinate value (H counter value) on the TV screen.

W0SX9~W0SX0	1800C0H	Bit 9~0	For W0 start point coordinates
W0EX9~W0EX0	1800C4H	Bit 9~0	For W0 end point coordinates
W1SX9~W1SX0	1800C8H	Bit 9~0	For W1 start point coordinates
W1EX9~W1EX0	1800CCH	Bit 9~0	For W1 end point coordinates

The bit configuration of the register changes according to the setting of the graphics mode. For normal graphics, the least significant bit becomes invalid data. For exclusive normal graphics, the most significant bit becomes invalid data; moreover, for special high-resolution graphics, the most significant bit becomes invalid data. Since it doesn't have an HO bit, values are in 2 pixel units. Table 8.1 shows the bit content of the window position register by graphic mode setting.

**Table 8.1 Bit content of window position register for horizontal coordinates**

Graphics Mode	WxxX9	WxxX8	WxxX7	WxxX6	WxxX5	WxxX4	WxxX3	WxxX2	WxxX1	WxxX0
Normal	H8	H7	H6	H5	H4	H3	H2	H1	H0	Invalid
Hi-Res	H9	H8	H7	H6	H5	H4	H3	H2	H1	H0
Exclusive Normal	Invalid	H8	H7	H6	H5	H4	H3	H2	H1	H0
Exclusive Hi-Res	Invalid	H9	H8	H7	H6	H5	H4	H3	H2	H1

Note: 0S, 0E, 1S, or 1E is entered in bit name for xx.

**Window position bit (for vertical coordinates): Window start/end Y bit (W0SY8 to W0SY0, W0EY8 to W0EY0, W1SY8 to W1SY0, W1EY8 to W1EY0)**

Designates the vertical start and end coordinates. The designated coordinate value is the coordinate value (V counter value) on the TV screen.

W0SY8~W0SY0	1800C2H	Bit 8~0	For W0 start point coordinates
W0EY8~W0EY0	1800C6H	Bit 8~0	For W0 end point coordinates
W1SY8~W1SY0	1800CAH	Bit 8~0	For W1 start point coordinates
W1EY8~W1EY0	1800CEH	Bit 8~0	For W1 end point coordinates

The bit configuration of the register changes according to the screen mode setting. Single-density interlace of Normal and high-resolution modes designate the V counter value in the respective even-numbered and odd-numbered fields.





The lowest significant bit is invalid for the double-density interlace of Normal and high-resolution modes. Remaining bits designate the V counter value in various fields. Bit content of the window position register by setting of the screen mode is shown in Table 8.2.

**Table 8.2 Bit content of the window position register used for vertical coordinates**

TV Screen (Interlace) Mode	WxxY8	WxxY7	WxxY6	WxxY5	WxxY4	WxxY3	WxxY2	WxxY1	WxxY0
Normal, Hi-Res (Non-interlace, Single-Density Interlace)	V8	V7	V6	V5	V4	V3	V2	V1	V0
Normal, Hi-Res (Double-Density Interlace)	V7	V6	V5	V4	V3	V2	V1	V0	Invalid
Exclusive Monitor	V8	V7	V6	V5	V4	V3	V2	V1	V0

**Note:** 0S, 0E, 1S or 1E is entered in bit name for xx.

## Normal Line Window

The Normal line window stores the horizontal start and end coordinates of each window line as a table in VRAM, and is obtained by designating the vertical start and end coordinates in the window position register. The area surrounded by selected coordinates is inside, the rest of the area is outside. The border line of the window is considered part of the inside. The Normal line window is illustrated in Figure 8.2.

The bit configuration of data stored in the line window table of horizontal start and end coordinates is shown in Figure 8.3.

Coordinates in each line can be selected in the non-interlace and double-density interlace modes, and in the single-density interlace mode for each two lines. Configuration of the Normal line window table is shown in Figure 8.4. If the start coordinate of either the horizontal or vertical direction is larger than the end coordinate, then the whole screen is considered an area outside the window.

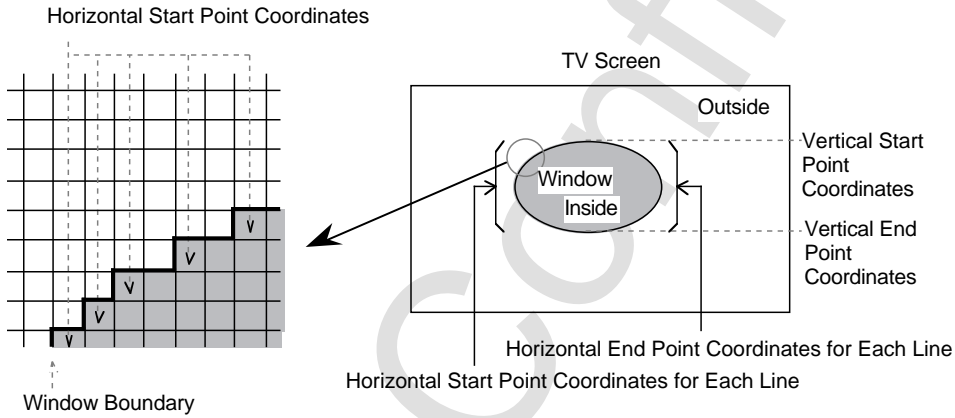
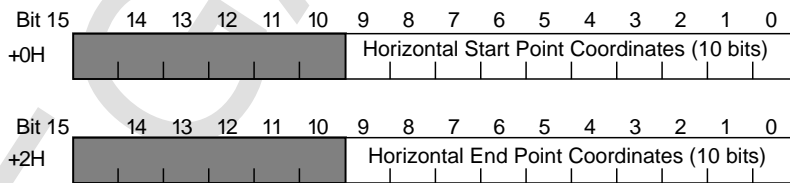

Figure 8.2 Normal line window



Note: Shaded areas are ignored

Figure 8.3 Bit configuration of Normal line window table data



Non-interlace or double-density interlace

Bit 15	Line Window Table (VRAM)	0
+00H	1st line horizontal start point coordinates	
+02H	1st line horizontal end point coordinates	
+04H	2nd line horizontal start point coordinates	
+06H	2nd line horizontal end point coordinates	
+08H	3rd line horizontal start point coordinates	
+0AH	3rd line horizontal end point coordinates	

Note: In the case of double-density interlace, store line data of both even and odd fields.

Single-density interlace

Bit 15	Line Window Table (VRAM)	0
+00H	1st & 2nd line horizontal start point coordinates	
+02H	1st & 2nd line horizontal end point coordinates	
+04H	3rd & 4th line horizontal start point coordinates	
+06H	3rd & 4th line horizontal end point coordinates	
+08H	5th & 6th line horizontal start point coordinates	
+0AH	5th & 6th line horizontal end point coordinates	

**Figure 8.4 Configuration of Normal line window table**

## Line Window Table Address Register

The line window table address register is a write-only 16-bit register that designates whether to make the Normal window the line window, as well as the lead address of that table. It is located from addresses 1800D8H through 1800DEH. Because the value is cleared to 0, it must be set after power on or reset.

	15	14	13	12	11	10	9	8
LWTA0U	W0LWE	~	~	~	~	~	~	~
1800D8H	7	6	5	4	3	2	1	0
	~	~	~	~	~	W0LWTA18	W0LWTA17	W0LWTA16

	15	14	13	12	11	10	9	8
LWTA0L	W0LWTA15	W0LWTA14	W0LWTA13	W0LWTA12	W0LWTA11	W0LWTA10	W0LWTA9	W0LWTA8
1800DAH	7	6	5	4	3	2	1	0
	W0LWTA7	W0LWTA6	W0LWTA5	W0LWTA4	W0LWTA3	W0LWTA2	W0LWTA1	~

	15	14	13	12	11	10	9	8
LWTA1U	W1LWE	~	~	~	~	~	~	~
1800DCH	7	6	5	4	3	2	1	0
	~	~	~	~	~	W1LWTA18	W1LWTA17	W1LWTA16

	15	14	13	12	11	10	9	8
LWTA1L	W1LWTA15	W1LWTA14	W1LWTA13	W1LWTA12	W1LWTA11	W1LWTA10	W1LWTA9	W1LWTA8
1800DEH	7	6	5	4	3	2	1	0
	W1LWTA7	W1LWTA6	W1LWTA5	W1LWTA4	W1LWTA3	W1LWTA2	W1LWTA1	~

### Line window enable bit (W0LWE, W1LWE)

Designates whether to make the Normal window a line window.

W0LWE	1800D8H	Bit 15	For W0
W1LWE	1800DCH	Bit 15	For W1

WxLWE	Process
0	Does not process Normal Window to Line Window
1	Processes Normal Window to Line Window

**Note:** 0 or 1 is entered in bit name for x.

When this bit is "1", the line window table must be stored in VRAM.



**Line window table address bit (W0LWTA18 to W0LWTA1, W1LWTA18 to W1LWTA1)**  
 Designates the lead address of the line window table in VRAM.

W0LWTA18~W0LWTA16	1800D8H	Bit 2~0	For W0
W0LWTA15~W0LWTA1	1800DAH	Bit 15~1	For W0
W1LWTA18~W1LWTA16	1800DCH	Bit 2~0	For W1
W1LWTA15~W1LWTA1	1800DEH	Bit 15~1	For W1

The actual lead address is calculated by the expression below. The most significant bit of the address is ignored when VRAM is 4 Mbits.

$$\begin{aligned} & \text{(Lead address of the line window table)} \\ & = (\text{Line window table address register value 18 bits}) \times 4\text{H} \end{aligned}$$

### Sprite Window

The sprite window is obtained by selecting the most significant bit of data when all frame buffer data of the sprite is palette format data and sprite types are 2 through 7. The most significant single bit is inside, and the rest of the area is outside. For more about sprite types see "Sprite types" in section "9.1 Sprite Data." Figure 8.5 shows a sprite window.

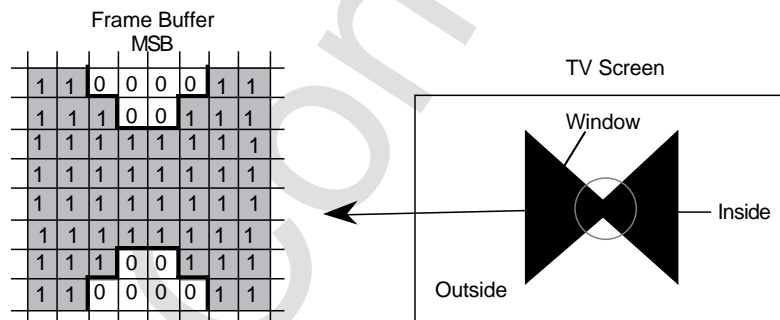

**Figure 8.5 Sprite Window**

## Sprite Control Register

The sprite control register controls sprites. This is a write-only 16-bit register that is at address 1800E0H. Because the value is cleared to 0, it must be set after power on or reset.

	15	14	13	12	11	10	9	8
SPCTL	~	~	SPCCCS1	SPCCCS0	~	SPCCN2	SPCCN1	SPCCN0
1800E0H	7	6	5	4	3	2	1	0
	~	~	SPCLMD	SPWINEN	SPTYPE3	SPTYPE2	SPTYPE1	SPTYPE0

### Sprite color calculation condition bit (SPCCCS1, SPCCCS0)

See "9.2 Priority and Color Calculation"

### Sprite color calculation condition number bit (SPCCN2 to SPCCN0)

See "9.2 Priority and Color Calculation"

### Sprite color mode bit (SPCLMD)

See "9.1 Sprite Data"

### Sprite window enable bit: SW enable bit (SPWINEN), bit 4

Designates whether to use the sprite window SW.

SPWINEN	Process
0	Does not use sprite window
1	Uses sprite window

This bit is only effective when the sprite color mode is mode 0, and for only sprites 2 to 7. When this bit is "1", the most significant bit of the sprite frame buffer is used as the bit for the sprite window. As a result, MSB shadow can no longer be used. For more about shadows see "14.1 Shadow Process."

Do not set this bit to 1, when setting SPCLMD bit to 1.

### Sprite type bit (SPTYPE3 to SPTYPE0)

See "9.1 Sprite Data"



## Window's Active Area for the Screen

Normal and sprite windows can designate whether to use a window in each scroll screen. The window being used can select inside or outside, in each window, as well as perform color calculation and transparent processes in active areas. When using multiple windows, the method of overlap can be selected from AND or OR logic. Figure 8.6 shows the active area when normal and sprite windows are overlaid by AND or OR logic.

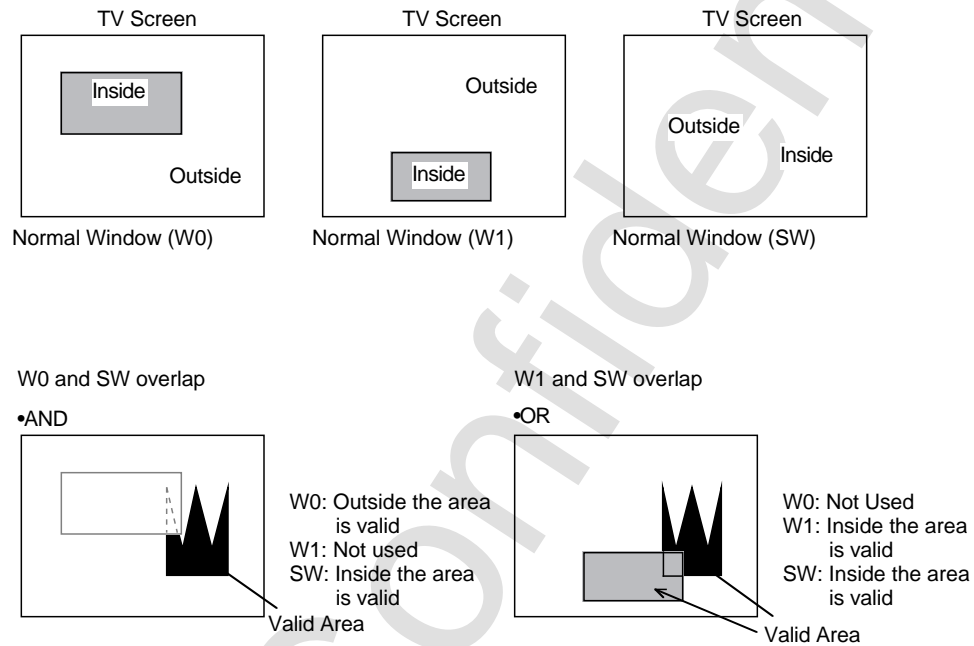

Figure 8.6 Active area of window

## 8.2 Window Process

The three window processes are:

1. Transparency process window
2. Rotation parameter window
3. Color calculation window

The transparency process window forces the selected window effective area to be transparent, and can be used in each screen.

When displaying the RBG0 screen, the rotation parameter window designates the area displaying the image obtained by rotation parameter A, and designates which image obtained by rotation parameter B is displayed. Images obtained by rotation parameter B are displayed in the active area of the designated window; images obtained by rotation parameter A are displayed outside the window's active area.

The color calculation window is a window in which color calculation in the active area of the designated window is not performed, and is effective for screens using the color calculation function.





Window process is shown in Figure 8.7.

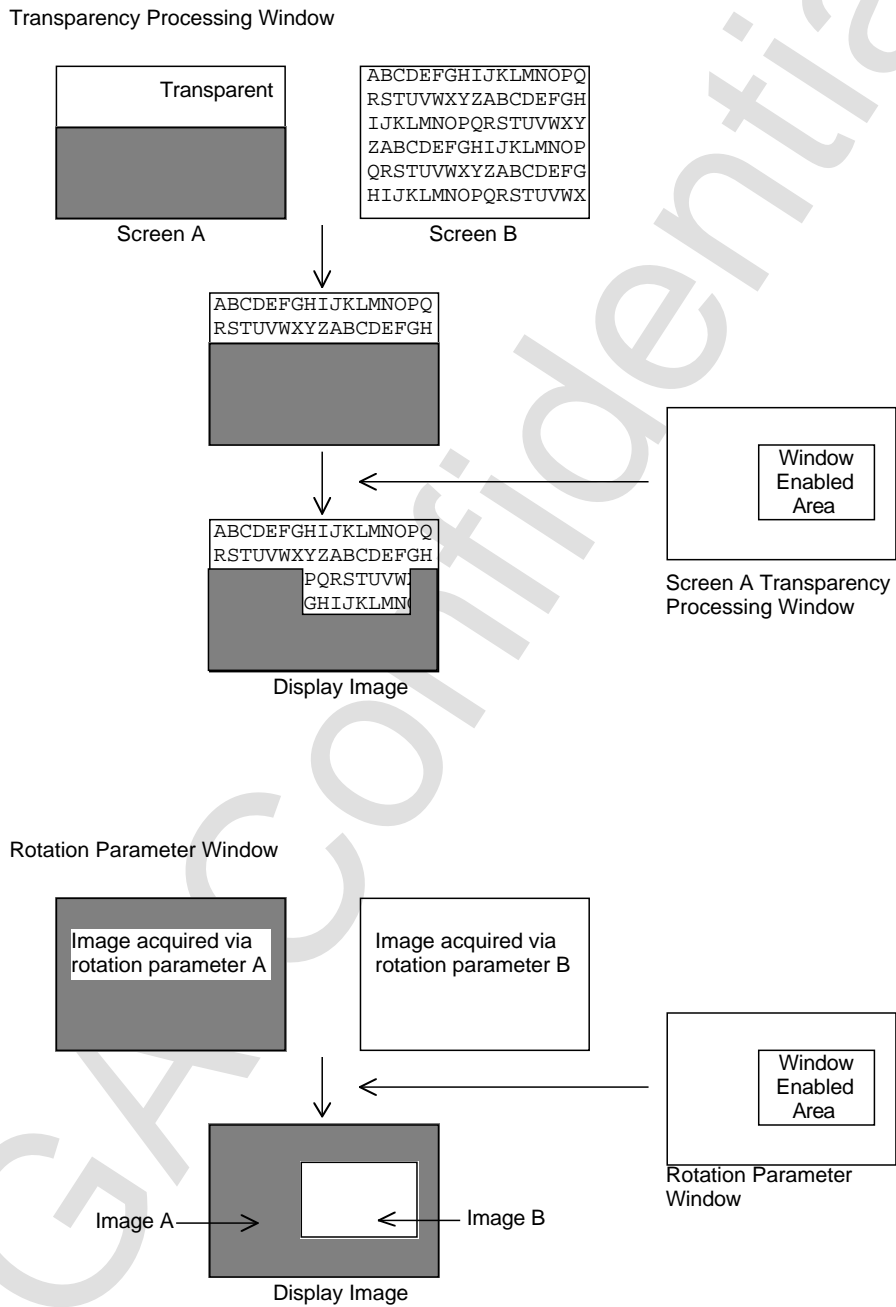

Figure 8.7 Window Process

Color Calculation Window

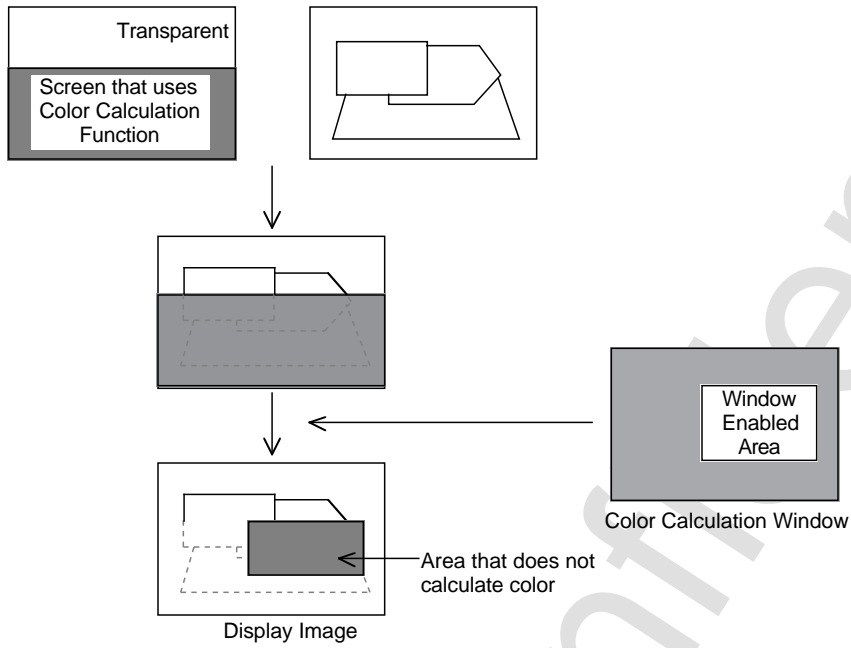

Figure 8.7 Window Process (continued)



## Window Control Register

Window control register designates the method for using windows in each screen, and is a write-only 16-bit register that is located from addresses 1800D0H through 1800D6H. Because the value is cleared to 0, it must be set after power on or reset.

	15	14	13	12	11	10	9	8
WCTLA	N1LOG	~	N1SWE	N1SWA	N1W1E	N1W1A	N1W0E	N1W0A
1800D0H	7	6	5	4	3	2	1	0
	N0LOG	~	N0SWE	N0SWA	N0W1E	N0W1A	N0W0E	N0W0A
	15	14	13	12	11	10	9	8
WCTLB	N3LOG	~	N3SWE	N3SWA	N3W1E	N3W1A	N3W0E	N3W0A
1800D2H	7	6	5	4	3	2	1	0
	N2LOG	~	N2SWE	N2SWA	N2W1E	N2W1A	N2W0E	N2W0A
	15	14	13	12	11	10	9	8
WCTLC	SPLOG	~	SPSWE	SPSWA	SPW1E	SPW1A	SPW0E	SPW0A
1800D4H	7	6	5	4	3	2	1	0
	R0LOG	~	R0SWE	R0SWA	R0W1E	R0W1A	R0W0E	R0W0A
	15	14	13	12	11	10	9	8
WCTLD	CCLOG	~	CCSWE	CCSWA	CCW1E	CCW1A	CCW0E	CCW0A
1800D6H	7	6	5	4	3	2	1	0
	RPLOG	~	~	~	RPW1E	RPW1A	RPW0E	RPW0A

**Window logic bit:** Logic bit (N0LOG, N1LOG, N2LOG, N3LOG, R0LOG, SPLOG, RPLOG, CCLOG)  
Designates the method of overlapping windows used in each screen.

N0LOG	1800D0H	Bit 7	Transparent Process Window for NBG0 (or RBG1)
N1LOG	1800D0H	Bit 15	Transparent Process Window for NBG1 (or EXBG)
N2LOG	1800D2H	Bit 7	Transparent Process Window for NBG2
N3LOG	1800D2H	Bit 15	Transparent Process Window for NBG3
R0LOG	1800D4H	Bit 7	Transparent Process Window for RBG0
SPLOG	1800D4H	Bit 15	Transparent Process Window for Sprite
RPLOG	1800D6H	Bit 7	For Rotation Parameter Window
CCLOG	1800D6H	Bit 15	For Color Calculation Window

xxLOG	Overlaid Logic
0	OR
1	AND

**Note:** N0, N1, N2, N3, R0, SP, RP or CC is entered in bit name for xx.

When W0, W1, and SW window enable bits are all 0, with this bit set to 0, the whole screen will be window disabled area, and with this bit set to 1, the whole screen will become window enabled area.

**Window enable bit (for W0): W0 enable bit (N0W0E, N1W0E, N2W0E, N3W0E, R0W0E, SPW0E, RPW0E, CCW0E)**

Designates whether to use the Normal window W0 in each screen.

N0W0E	1800D0H	Bit 1	Transparent Process Window for NBG0 (or RBG1)
N1W0E	1800D0H	Bit 9	Transparent Process Window for NBG1 (or EXBG)
N2W0E	1800D2H	Bit 1	Transparent Process Window for NBG2
N3W0E	1800D2H	Bit 9	Transparent Process Window for NBG3
R0W0E	1800D4H	Bit 1	Transparent Process Window for RBG0
SPW0E	1800D4H	Bit 9	Transparent Process Window for Sprite
RPW0E	1800D6H	Bit 1	For Rotation Parameter Window
CCW0E	1800D6H	Bit 9	For Color Calculation Window

xxW0E	Process
0	Does not use W0 window
1	Uses W0 window

**Note:** N0, N1, N2, N3, R0, SP, RP, or CC is entered in bit name for xx.

**Window enable bit (for W1): W1 enable bit (N0W1E, N1W1E, N2W1E, N3W1E, R0W1E, SPW1E, RPW1E, CCW1E)**

Designates whether to use the Normal window W1 in each screen.



N0W1E	1800D0H	Bit 3	Transparent Process Window for NBG0 (or RBG1)
N1W1E	1800D0H	Bit 11	Transparent Process Window for NBG1 (or EXBG)
N2W1E	1800D2H	Bit 3	Transparent Process Window for NBG2
N3W1E	1800D2H	Bit 11	Transparent Process Window for NBG3
R0W1E	1800D4H	Bit 3	Transparent Process Window for RBG0
SPW1E	1800D4H	Bit 11	Transparent Process Window for Sprite
RPW1E	1800D6H	Bit 3	For Rotation Parameter Window
CCW1E	1800D6H	Bit 11	For Color Calculation Window

xxW1E	Process
0	Does not use W1 window
1	Uses W1 window

**Note:** N0, N1, N2, N3, R0, SP, RP, or CC is entered in bit name for xx.

**Window enable bit (for SW): SW enable bit (N0SWE, N1SWE, N2SWE, N3SWE, R0SWE, SPSWE, CCSWE)**

Designates whether to use the sprite window SW in each screen.

N0SWE	1800D0H	Bit 5	Transparent Process Window for NBG0 (or RBG1)
N1SWE	1800D0H	Bit 13	Transparent Process Window for NBG1 (or EXBG)
N2SWE	1800D2H	Bit 5	Transparent Process Window for NBG2
N3SWE	1800D2H	Bit 13	Transparent Process Window for NBG3
R0SWE	1800D4H	Bit 5	Transparent Process Window for RBG0
SPSWE	1800D4H	Bit 13	Transparent Process Window for Sprite
CCSWE	1800D6H	Bit 13	For Color Calculation Window

xxSWE	Process
0	Does not use SW window
1	Uses SW window

**Note:** N0, N1, N2, N3, R0, SP, or CC is entered in bit name for xx.

When using the sprite window, set the sprite window enable bit (SPWINEN) of the sprite control register to 1.

**Window area bit (for W0): W0 area bit (N0W0A, N1W0A, N2W0A, N3W0A, R0W0A, SPW0A, RPW0A, CCW0A)**

Designates the valid area of the Normal window W0 used in each screen.

N0W0A	1800D0H	Bit 0	Transparent Process Window for NBG0 (or RBG1)
N1W0A	1800D0H	Bit 8	Transparent Process Window for NBG1 (or EXBG)
N2W0A	1800D2H	Bit 0	Transparent Process Window for NBG2
N3W0A	1800D2H	Bit 8	Transparent Process Window for NBG3
R0W0A	1800D4H	Bit 0	Transparent Process Window for RBG0
SPW0A	1800D4H	Bit 8	Transparent Process Window for Sprite
RPW0A	1800D6H	Bit 0	For Rotation Parameter Window
CCW0A	1800D6H	Bit 8	For Color Calculation Window

xxW0A	Process
0	Enables the inside of W0 window
1	Enables the outside of W0 window

**Note:** N0, N1, N2, N3, R0, SP, RP, or CC is entered in bit name for xx.

**Window area bit (for W1): W1 area bit (N0W1A, N1W1A, N2W1A, N3W1A, R0W1A, SPW1A, RPW1A, CCW1A)**

Designates the valid area of the Normal window W1 used in each screen.

N0W1A	1800D0H	Bit 2	Transparent Process Window for NBG0 (or RBG1)
N1W1A	1800D0H	Bit 10	Transparent Process Window for NBG1 (or EXBG)
N2W1A	1800D2H	Bit 2	Transparent Process Window for NBG2
N3W1A	1800D2H	Bit 10	Transparent Process Window for NBG3
R0W1A	1800D4H	Bit 2	Transparent Process Window for RBG0
SPW1A	1800D4H	Bit 10	Transparent Process Window for Sprite
RPW1A	1800D6H	Bit 2	For Rotation Parameter Window
CCW1A	1800D6H	Bit 10	For Color Calculation Window

xxW1A	Process
0	Enables the inside of W1 window
1	Enables the outside of W1 window

**Note:** N0, N1, N2, N3, R0, SP, RP, or CC is entered in bit name for xx.

**Window area bit (for SW): SW area bit (N0SWA, N1SWA, N2SWA, N3SWA, R0SWA, SPSWA, CCSWA)**

Designates the valid area of the sprite window SW used in each screen.



N0SWA	1800D0H	Bit 4	Transparent Process Window for NBG0 (or RBG1)
N1SWA	1800D0H	Bit 12	Transparent Process Window for NBG1 (or EXBG)
N2SWA	1800D2H	Bit 4	Transparent Process Window for NBG2
N3SWA	1800D2H	Bit 12	Transparent Process Window for NBG3
R0SWA	1800D4H	Bit 4	Transparent Process Window for RBG0
SPSWA	1800D4H	Bit 12	Transparent Process Window for Sprite
CCSWA	1800D6H	Bit 12	For Color Calculation Window

xxSWA	Process
0	Enables the inside of SW window
1	Enables the outside of SW window

**Note:** N0, N1, N2, N3, R0, SP or CC is entered in bit name for xx.

(This page was blank in the original Japanese document)

SEGA Confidential





## Chapter 9 Sprite Data

9.1	Sprite Data .....	200
	Sprite Types .....	200
	Sprite Color Mode .....	203
9.2	Priority and Color Calculation .....	204
	Priority Number Selection .....	204
	Color Calculation Enable Conditions .....	205
	Color Calculation Ratio Selection .....	206
	Sprite Control Register .....	207
	Priority Number Register .....	209
	Color Calculation Ratio Registers .....	210

## 9.1 Sprite Data

Sprite frame buffer data received from VDP1 may be either 8-bit pixel or 16-bit pixels. When the 16-bit pixel format is read, the data may be either RGB or palette format, but the frame buffer must be either all 8-bit pixel or all 16-bit pixels.

### Sprite Types

When VDP2 receives palette format sprite data written by VDP1 in the frame buffer, there are eight types of bit configurations for 16 bits per pixel and eight types of bit configurations for 8 bits per pixel, for a total of 16 types. These are called sprite types. Data per one dot consists of dot color data, priority bit, color calculation ratio bit, and shadow bit composed from dot color code and palette number. Each bit number changes depending on the sprite type. The value of a bit not having a high enough order in the various bits is regarded as 0.

Sprite data of RGB format is composed of data of RGB for each 5-bit and color format discriminator bit. Priority bits, color calculation ratio bits, and shadow bits are considered to be 0.

Sprite data, when 16-bit per pixel, designates types 0 through 7; when 8 bit per pixel, designates types 8 through F. When types C through F are designated, priority bit, color calculation ratio bit, and dot color data bit have a shared bit. The shared bits are shown in Table 9.1.

**Table 9.1 Shared Bits**

Sprite Type	Shared Bits			
	SP1	SP0	SC1	SC0
Type C	-	PR0 and DC7	-	-
Type D	-	PR0 and DC7	-	CC0 and DC6
Type E	PR1 and DC7	PR0 and DC6	-	-
Type F	-	-	CC1 and DC7	CC0 and DC6

SP: Priority bit, color RAM address shared bit

SC: Color calculation ratio bit, color RAM address shared bit

PR: Priority bit

DC: Dot color data

CC: Color calculation ratio bit



Sprite types are shown in Figure 9.1.

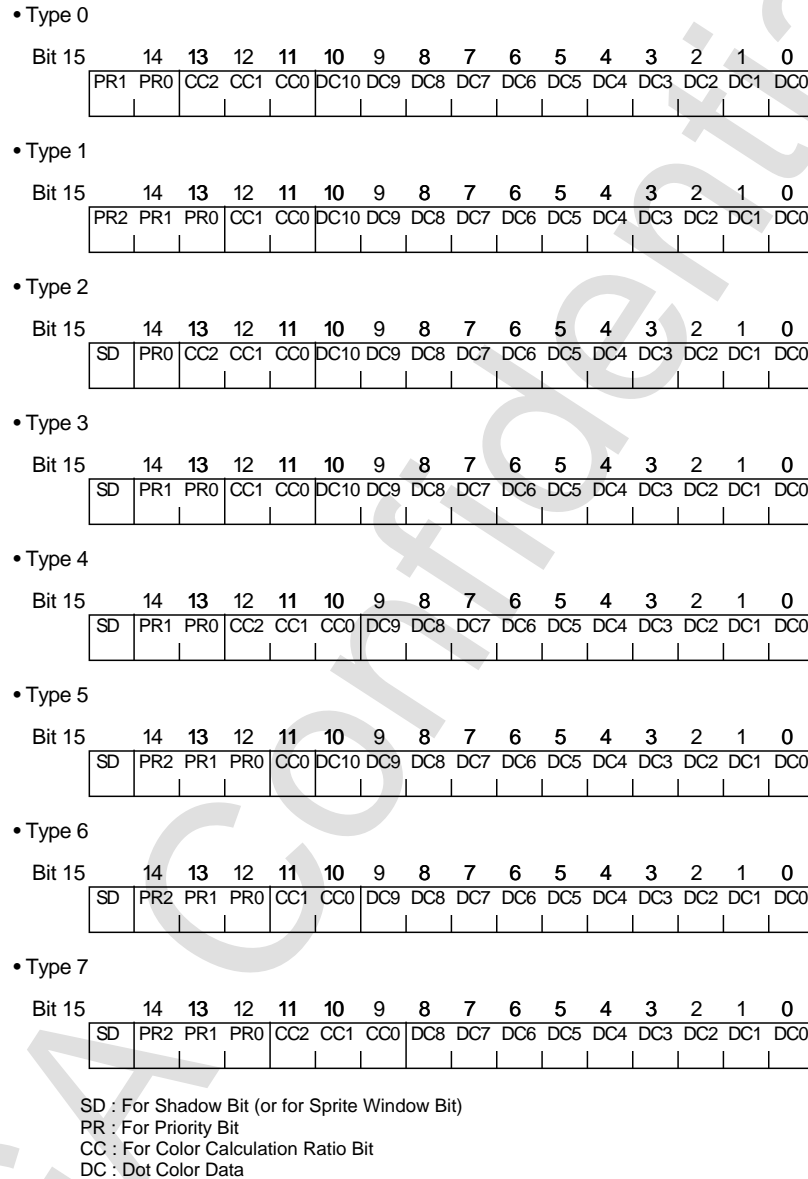
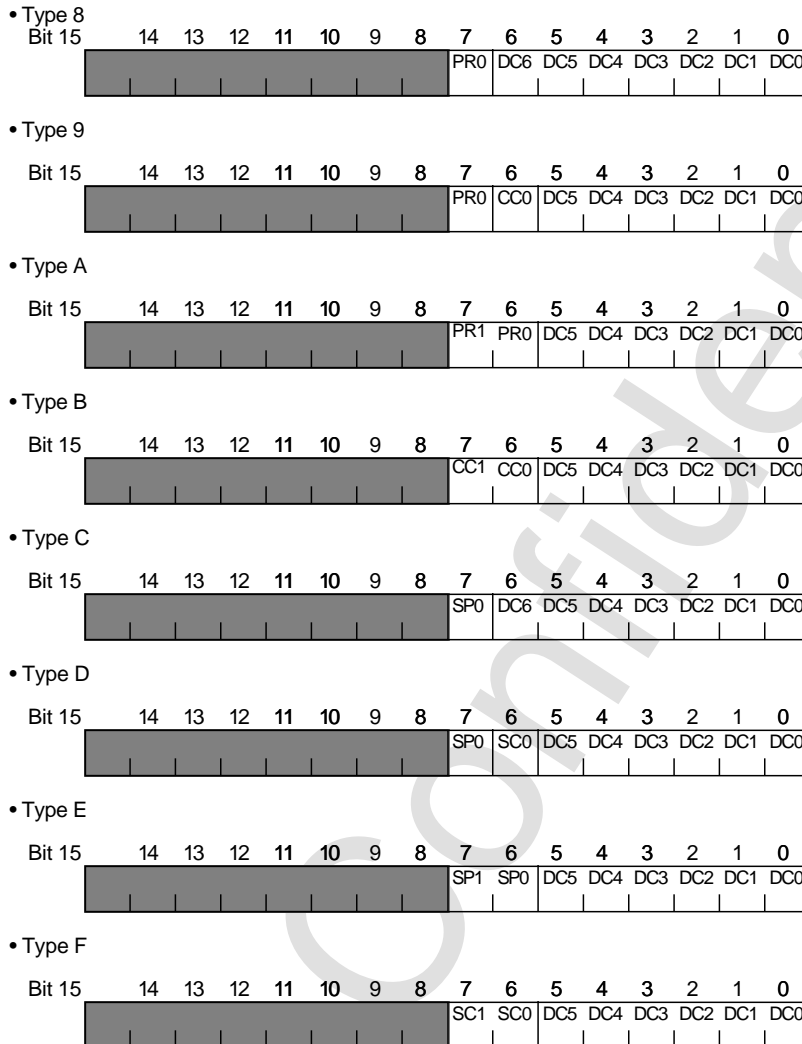

Figure 9.1 Sprite types



SD : For Shadow Bit (or for Sprite Window Bit)  
 PR : For Priority Bit  
 CC : For Color Calculation Ratio Bit  
 DC : Dot Color Data  
 SP : For Priority Bit, Color RAM address shared bits  
 SC : For Color Calculation Ratio Bit, Color RAM address shared bits  
 Note: Shaded areas are ignored.

**Figure 9.1 Sprite types (continued)**



## Sprite Color Mode

Sprite character data has a palette and RGB format, the same as the scroll screen. When the bit count per one dot is 16 (bits), all 16-bits composed of bits selected by the sprite type can be used when data inside the frame buffer is only the palette format. However, when data of the palette and RGB formats are mixed (because the most significant bit is used to discriminate the color format,) palette format data is be set to 0 and RGB format set to "1". Palette format data is then processed with the value of the selected sprite type MSB (priority bit or shadow bit) as 0. Sprite data when data of palette and RGB formats are mixed is shown in Figure 9.2.

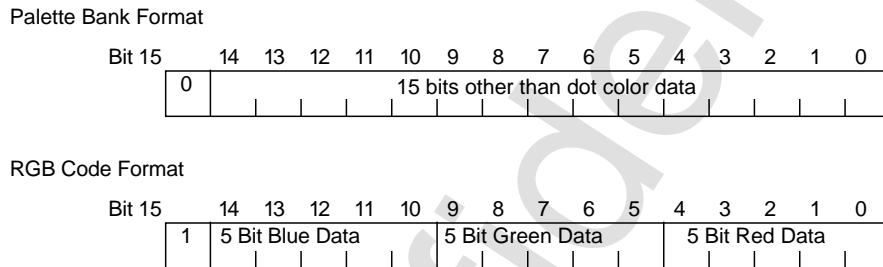

Figure 9.2 Sprite data when palette format and RGB format data are mixed

## 9.2 Priority and Color Calculation

The priority of sprite and scroll screen is selected according to the size of 3-bit value called the priority number. Sprites can designate a maximum of eight priority numbers and can select one for each character according to the priority bit within sprite data.

When using the color calculation function between the sprite and scroll screen, it can be determined whether to perform color calculation by the value of priority number selected by sprite character. Up to eight color calculation ratios can be selected; with one of each character being selected by color calculation ratio in sprite data.

### Priority Number Selection

Sprite priority number selects one from among eight priority numbers in each sprite character by the priority bit of the selected sprite type. When the priority bit of the selected sprite type is 2 bits or less, bits lower than 2 are read as 0, and a 3-bit without a priority number bit are read as 0. When sprite data is in an RGB format, sprite register 0 is selected. The priority number register selected through the value of the priority bit is shown in Table 9.2.

**Table 9.2 Selection of sprite priority number register**

For Priority Bits			Priority Number Register Selection
PR2	PR1	PR0	
0	0	0	For Sprite Register 0 (1800F0H bit 2~0)
0	0	1	For Sprite Register 1 (1800F0H bit 10~8)
0	1	0	For Sprite Register 2 (1800F2H bit 2~0)
0	1	1	For Sprite Register 3 (1800F2H bit 10~8)
1	0	0	For Sprite Register 4 (1800F4H bit 2~0)
1	0	1	For Sprite Register 5 (1800F4H bit 10~8)
1	1	0	For Sprite Register 6 (1800F6H bit 2~0)
1	1	1	For Sprite Register 7 (1800F6H bit 10~8)



## Color Calculation Enable Conditions

A sprite not only designates whether to do color calculation by the entire sprite, but can also designate by the value of the priority number selected in each character and the value of the most significant bit of color data selected in each dot. There are four conditions that can be selected.

1. When (priority number)  $\leq$  (color calculation condition number)
2. When (priority number) = (color calculation condition number)
3. When (priority number)  $\geq$  (color calculation condition number)
4. When color data most significant bit is 1

The color calculation condition number is designated in the sprite control register by the value of the priority number selected in each sprite character, and the 3-bit value for comparing size. These conditions are in effect only when the SPCCEN bit of the color calculation control register is 1; color calculation will not be done when the register is 0.

## Color Calculation Ratio Selection

The color calculation ratio of sprites select one of eight color calculation ratios in each sprite character by the color calculation ratio bit of the designated sprite type data. When two or less bits are used for color calculation ratio of the designated sprite type, the low bit is read as 0. When there is no color calculation ratio bit, 8-bit is also read as 0. When sprite data is in an RGB format, the sprite register 0 is selected.

Selection of the color calculation ratio register through the value of the color calculation ratio bit is shown in Table 9.3.

**Table 9.3 Selection of sprite color calculation ratio register**

For Color Calculation Ratio Bits			Color Calculation Ratio Register Selection
CC2	CC1	CC0	
0	0	0	For Sprite Register 0 (180100H bit 4~0)
0	0	1	For Sprite Register 1 (180100H bit 12~8)
0	1	0	For Sprite Register 2 (180102H bit 4~0)
0	1	1	For Sprite Register 3 (180102H bit 12~8)
1	0	0	For Sprite Register 4 (180104H bit 4~0)
1	0	1	For Sprite Register 5 (180104H bit 12~8)
1	1	0	For Sprite Register 6 (180106H bit 4~0)
1	1	1	For Sprite Register 7 (180106H bit 12~8)





## Sprite Control Register

The sprite control register controls sprite data, and is a write-only 16-bit register located at address 1800E0H. Because the value is cleared to 0 after power on or reset, it must be set.

	15	14	13	12	11	10	9	8
SPCTL	~	~	SPCCCS1	SPCCCS0	~	SPCCN2	SPCCN1	SPCCN0
1800E0H	7	6	5	4	3	2	1	0
	~	~	SPCLMD	SPWINEN	SPTYPE3	SPTYPE2	SPTYPE1	SPTYPE0

### Sprite color calculation condition bit (SPCCCS1, SPCCCS0), bits 13, 12

Designates the color calculation condition of sprites.

SPCCCS	SPCCCS1	SPCCCS0	Condition
0	0	0	(Priority number) ≤ (Color calculation condition number) only
1	0	1	(Priority number) = (Color calculation condition number) only
2	1	0	(Priority number) ≥ (Color calculation condition number) only
3	1	1	Only when Color Data MSB is 1.

When the sprite color format is RGB, color calculation is always performed if SPCCCS is set to "3".

### Sprite color calculation number bit (SPCCN2 to SPCCN0), bits 10 to 8

Designates the color calculation condition number of sprites.

This value is ignored when SPCCCS is set to "3".

### Sprite color mode bit (SPCLMD), bit 5

Designates the sprite color mode.

SPCLMD	Sprite Color Format Data
0	Sprite data is all in palette format
1	Sprite data is in palette format and RGB format

Do not designate a "1" when sprite data are 8-bit pixels.

**Sprite window enable bit (SPWINEN), bit 4**

See "8.1 Window Area"

**Sprite type bit (STYPE3 to STYPE0), bits 3 to 0**

Designates the sprite type.

STYPE3	STYPE2	STYPE1	STYPE0	Sprite Data Type
0	0	0	0	Type 0
0	0	0	1	Type 1
0	0	1	0	Type 2
0	0	1	1	Type 3
0	1	0	0	Type 4
0	1	0	1	Type 5
0	1	1	0	Type 6
0	1	1	1	Type 7
1	0	0	0	Type 8
1	0	0	1	Type 9
1	0	1	0	Type A
1	0	1	1	Type B
1	1	0	0	Type C
1	1	0	1	Type D
1	1	1	0	Type E
1	1	1	1	Type F

When sprite data are 16-bit pixels, designate type 0 to 7; and when 8-bit pixels, designate type 8 to F.



## Priority Number Register

The priority number register designates the priority number, and is a write-only 16-bit register located at addresses 1800F0H through 1800F6H. Because the value is cleared to 0 after power on or reset, it must be set.

	15	14	13	12	11	10	9	8
PRISA	~	~	~	~	~	S1PRIN2	S1PRIN1	S1PRIN0
1800F0H	7	6	5	4	3	2	1	0
	~	~	~	~	~	S0PRIN2	S0PRIN1	S0PRIN0
	15	14	13	12	11	10	9	8
PRISB	~	~	~	~	~	S3PRIN2	S3PRIN1	S3PRIN0
1800F2H	7	6	5	4	3	2	1	0
	~	~	~	~	~	S2PRIN2	S2PRIN1	S2PRIN0
	15	14	13	12	11	10	9	8
PRISC	~	~	~	~	~	S5PRIN2	S5PRIN1	S5PRIN0
1800F4H	7	6	5	4	3	2	1	0
	~	~	~	~	~	S4PRIN2	S4PRIN1	S4PRIN0
	15	14	13	12	11	10	9	8
PRISD	~	~	~	~	~	S7PRIN2	S7PRIN1	S7PRIN0
1800F6H	7	6	5	4	3	2	1	0
	~	~	~	~	~	S6PRIN2	S6PRIN1	S6PRIN0

**Sprite priority number bit (for sprite) (S0PRIN2 to S0PRIN0, S1PRIN2 to S1PRIN0, S2PRIN2 to S2PRIN0, S3PRIN2 to S3PRIN0, S4PRIN2 to S4PRIN0, S5PRIN2 to S5PRIN0, S6PRIN2 to S6PRIN0, S7PRIN2 to S7PRIN0)**

Designates the sprite priority number.

S0PRIN2~S0PRIN0	1800F0H	Bit 2~0	For Sprite Register 0
S1PRIN2~S1PRIN0	1800F0H	Bit 10~8	For Sprite Register 1
S2PRIN2~S2PRIN0	1800F2H	Bit 2~0	For Sprite Register 2
S3PRIN2~S3PRIN0	1800F2H	Bit 10~8	For Sprite Register 3
S4PRIN2~S4PRIN0	1800F4H	Bit 2~0	For Sprite Register 4
S5PRIN2~S5PRIN0	1800F4H	Bit 10~8	For Sprite Register 5
S6PRIN2~S6PRIN0	1800F6H	Bit 2~0	For Sprite Register 6
S7PRIN2~S7PRIN0	1800F6H	Bit 10~8	For Sprite Register 7

Display priority order increases with the size of the priority number. Sprite characters that use the register set to a priority number value of 0 are treated as transparent and are not displayed.

### Color Calculation Ratio Registers

The color calculation ratio registers selects the color calculation ratio, and are write-only 16-bit registers located at addresses 180100H through 180106H. Because they are cleared to 0 after power on or reset, they must be set.

	15	14	13	12	11	10	9	8
CCRSA	~	~	~	S1CCRT4	S1CCRT3	S1CCRT2	S1CCRT1	S1CCRT0
180100H	7	6	5	4	3	2	1	0
	~	~	~	S0CCRT4	S0CCRT3	S0CCRT2	S0CCRT1	S0CCRT0
	15	14	13	12	11	10	9	8
CCRSB	~	~	~	S3CCRT4	S3CCRT3	S3CCRT2	S3CCRT1	S3CCRT0
180102H	7	6	5	4	3	2	1	0
	~	~	~	S2CCRT4	S2CCRT3	S2CCRT2	S2CCRT1	S2CCRT0
	15	14	13	12	11	10	9	8
CCRSC	~	~	~	S5CCRT4	S5CCRT3	S5CCRT2	S5CCRT1	S5CCRT0
180104H	7	6	5	4	3	2	1	0
	~	~	~	S4CCRT4	S4CCRT3	S4CCRT2	S4CCRT1	S4CCRT0
	15	14	13	12	11	10	9	8
CCRSB	~	~	~	S7CCRT4	S7CCRT3	S7CCRT2	S7CCRT1	S7CCRT0
180106H	7	6	5	4	3	2	1	0
	~	~	~	S6CCRT4	S6CCRT3	S6CCRT2	S6CCRT1	S6CCRT0

**Sprite color calculation ratio bit (S0CCRT4 to S0CCRT0, S1CCRT4 to S1CCRT0, S2CCRT4 to S2CCRT0, S3CCRT4 to S3CCRT0, S4CCRT4 to S4CCRT0, S5CCRT4 to S5CCRT0, S6CCRT4 to S6CCRT0, S7CCRT4 to S7CCRT0)**

Designates the sprite color calculation ratio. The color calculation ratio is for a value 1/32 of RGB various color data.



S0CCRT4~S0CCRT0	180100H	Bit 4~0	For Sprite Register 0
S1CCRT4~S1CCRT0	180100H	Bit 12~8	For Sprite Register 1
S2CCRT4~S2CCRT0	180102H	Bit 4~0	For Sprite Register 2
S3CCRT4~S3CCRT0	180102H	Bit 12~8	For Sprite Register 3
S4CCRT4~S4CCRT0	180104H	Bit 4~0	For Sprite Register 4
S5CCRT4~S5CCRT0	180104H	Bit 12~8	For Sprite Register 5
S6CCRT4~S6CCRT0	180106H	Bit 4~0	For Sprite Register 6
S7CCRT4~S7CCRT0	180106H	Bit 12~8	For Sprite Register 7

SEGA Confidential

xxCCRT4	xxCCRT3	xxCCRT2	xxCCRT1	xxCCRT0	Color Calculation Ratio Top Image : Second Image
0	0	0	0	0	31:1
0	0	0	0	1	30:2
0	0	0	1	0	29:3
0	0	0	1	1	28:4
0	0	1	0	0	27:5
0	0	1	0	1	26:6
0	0	1	1	0	25:7
0	0	1	1	1	24:8
0	1	0	0	0	23:9
0	1	0	0	1	22:10
0	1	0	1	0	21:11
0	1	0	1	1	20:12
0	1	1	0	0	19:13
0	1	1	0	1	18:14
0	1	1	1	0	17:15
0	1	1	1	1	16:16
1	0	0	0	0	15:17
1	0	0	0	1	14:18
1	0	0	1	0	13:19
1	0	0	1	1	12:20
1	0	1	0	0	11:21
1	0	1	0	1	10:22
1	0	1	1	0	9:23
1	0	1	1	1	8:24
1	1	0	0	0	7:25
1	1	0	0	1	6:26
1	1	0	1	0	5:27
1	1	0	1	1	4:28
1	1	1	0	0	3:29
1	1	1	0	1	2:30
1	1	1	1	0	1:31
1	1	1	1	1	0:32

**Note:** S0 to S7 are entered in bit name for xx.

This register is in effect only when the CCMD bit of the color calculation control register is 0, and is ignored when "1".



## Chapter 10 Pixels

Introduction .....	214
10.1 Palette Format Pixels .....	214
Sprite Dot Pixels .....	214
Scroll Dot Pixels .....	216
Color RAM Address Offset Register .....	217
10.2 RGB Format Pixels .....	218
Sprite Pixels .....	218
Scroll Pixels .....	218
10.3 Special Function Code .....	220
Special Function Code Select Register .....	221
Special Function Code Register .....	222

## Introduction

When sprites and dot color data of each scroll screen are in a palette format, the color RAM address offset register value added to the dot color data (configured from the palette number and dot color code) becomes the color RAM address. Color data of that address is output as color data. In the RGB format, dot color data composed of individual red, green and blue values are pixels.

Scroll screen dot color data in a palette format designates whether to use special priority and special color calculation functions according to the lowest 4-bit color data.

### 10.1 Palette Format Pixels

Palette format pixels are 11 bits wide, and is the color RAM addresses that store pixel data—the value of the color RAM address offset register of the corresponding screen added to the highest 3-bits.

#### Sprite Dot Pixels

Palette format sprite pixels change according to the sprite type that has been designated. When pixels designate sprite types that are 10-bit or lower, missing high-order bits are taken as 0, and the sprite color RAM address offset value is added to the highest 3 bits and is treated as the color RAM address of that dot. When the color RAM mode is set to mode 0 or mode 2, the highest bit of the color RAM address will be ignored.





Palette format sprite pixels are shown in Figure 10.1. The sprite color RAM address is shown in Figure 10.2.

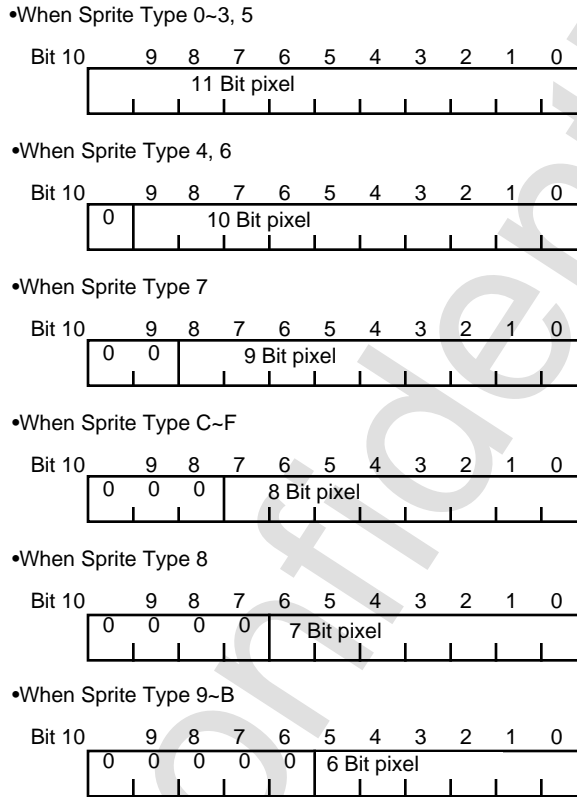

**Figure 10.1** Palette format sprite dot color data

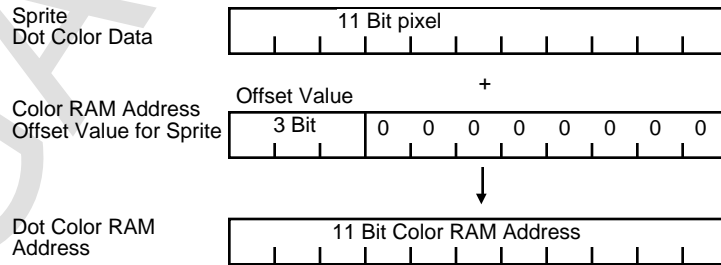

Note: When Color RAM is in mode 0 or mode 2, the MSB of the color RAM address is ignored.

**Figure 10.2** Sprite Color RAM Address

## Scroll Dot Pixels

Scroll pixels in a palette format changes according to the designated character color count. The color RAM address offset value corresponding to each surface is added to the highest 3 bits of 11-bit dot color data, and is treated as the color RAM address of that dot. When color RAM mode is set to mode 0 or mode 2, the highest bit of color RAM address will be ignored.

Because the line color screen doesn't have a corresponding color RAM address offset value, the 11-bit value read from line color screen table becomes the color RAM address. Palette format scroll dot color data is shown in Figure 10.3. The scroll screen color RAM address is shown in Figure 10.4.

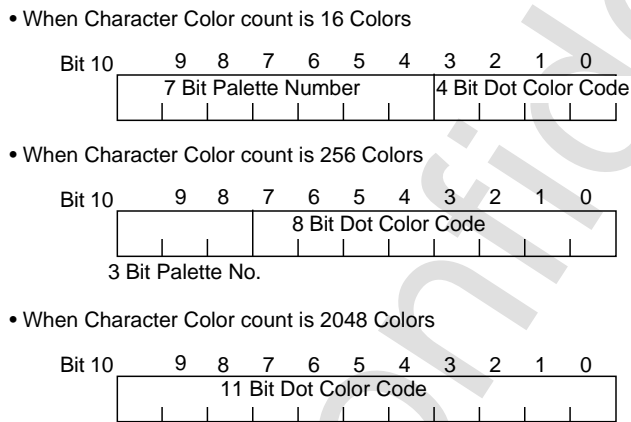

**Figure 10.3** Palette format scroll dot color data

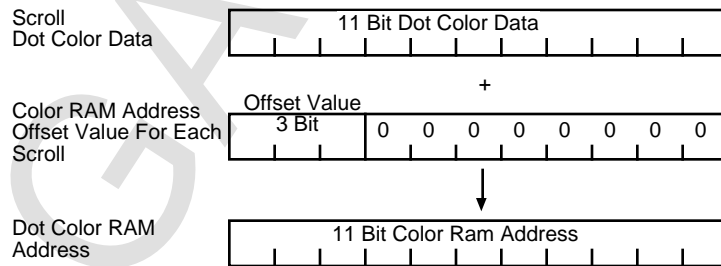

Note: When the color RAM mode is 0 or 2, the color RAM address MSB is ignored.

**Figure 10.4** Scroll Color RAM Address



## Color RAM Address Offset Register

The color RAM address offset register is a write only 16-bit register that designates the sprite and color RAM address offset values corresponding to each scroll screen. It is located at addresses 1800E4H through 1800E7. Because the value is cleared to 0 after power on or reset, you must set it.

	15	14	13	12	11	10	9	8
CRAOFA 1800E4H	~	N3CAOS2	N3CAOS1	N3CAOS0	~	N2CAOS2	N2CAOS1	N2CAOS0
	7	6	5	4	3	2	1	0
	~	N1CAOS2	N1CAOS1	N1CAOS0	~	N0CAOS2	N0CAOS1	N0CAOS0
	15	14	13	12	11	10	9	8
CRAOFB 1800E6H	~	~	~	~	~	~	~	~
	7	6	5	4	3	2	1	0
	~	SPCAOS2	SPCAOS1	SPCAOS0	~	R0CAOS2	R0CAOS1	R0CAOS0

**Color RAM address offset bit (N0CAOS2 to N0CAOS0, N1CAOS2 to N1CAOS0, N2CAOS2 to N2CAOS0, N3CAOS2 to N3CAOS0, R0CAOS2 to R0CAOS0, SPCAOS2 to SPCAOS0)**

Designates color RAM address offset values with respect to the sprite and each scroll screen.

N0CAOS0~N0CAOS2	1800E4H	Bit 2~0	For NBG0 (or RBG1)
N1CAOS0~N1CAOS2	1800E4H	Bit 6~4	For NBG1 (or EXBG)
N2CAOS0~N2CAOS2	1800E4H	Bit 10~8	For NBG2
N3CAOS0~N3CAOS3	1800E4H	Bit 14~12	For NBG3
R0CAOS0~R0CAOS2	1800E6H	Bit 2~0	For RBG0
SPCAOS0~SPCAOS2	1800E6H	Bit 6~4	For Sprite

The actual color RAM address offset value is calculated by the expression below. When the color RAM mode is set to mode 0 or mode 2, the highest bit of color RAM address that calculated the color RAM address offset value will be ignored.

When color RAM mode is mode 0 or mode 2:

$$\begin{aligned} & \text{(color RAM address offset value [= offsetReg << 9])} \\ & \quad = \text{(color RAM address offset register 3-bit value)} \times 200\text{H} \end{aligned}$$

When color RAM mode is mode L:

$$\begin{aligned} & \text{(color RAM address offset value [= offsetReg << 10])} \\ & \quad = \text{(color RAM address offset register 3-bit value)} \times 400\text{H} \end{aligned}$$

## 10.2 RGB Format Pixels

RGB format dot color data is 15-bit in sprite and 15-bit or 24-bit data, depending on character color count in scroll, and becomes dot color data without going through color RAM. When dot color data is 15-bit, the lowest three bits of each individual is fixed at 0 and used.

### Sprite Pixels

RGB format sprite dot color data is RGB 5-bit data that outputs each of the lowest 3 bits fixed at 0. RGB format sprite dot color data is shown in Figure 10.5.

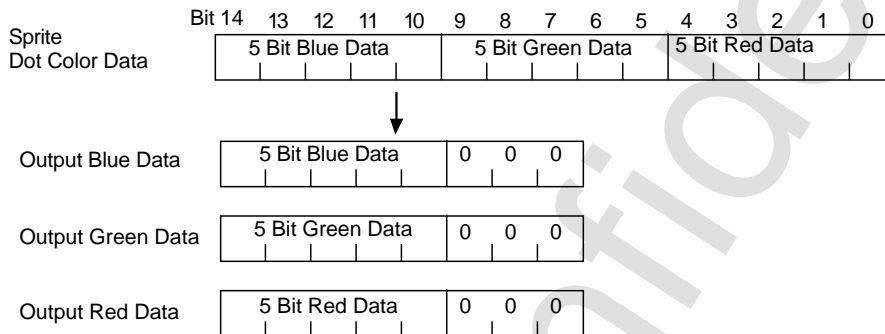

Figure 10.5 RGB format sprite dot color data

### Scroll Pixels

RGB format scroll dot color data changes according to the character color count. When 15-bit, the lowest three bits of each individual RGB is fixed at 0 and output.

The back screen is output by fixing the lower 3-bit of each RGB at 0, the same as when the character color count of the scroll screen is 32,768 colors.



Scroll dot color data of the RGB format is shown in Figure 10.6.

- When Character Color Count is 32768 Colors

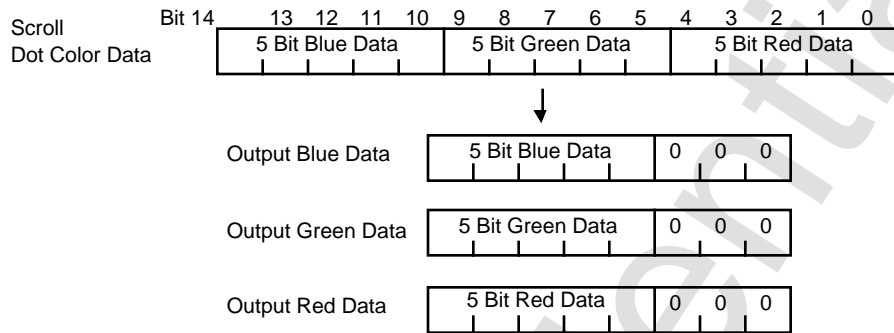

- When Character Color Count is 16,770,000 Colors

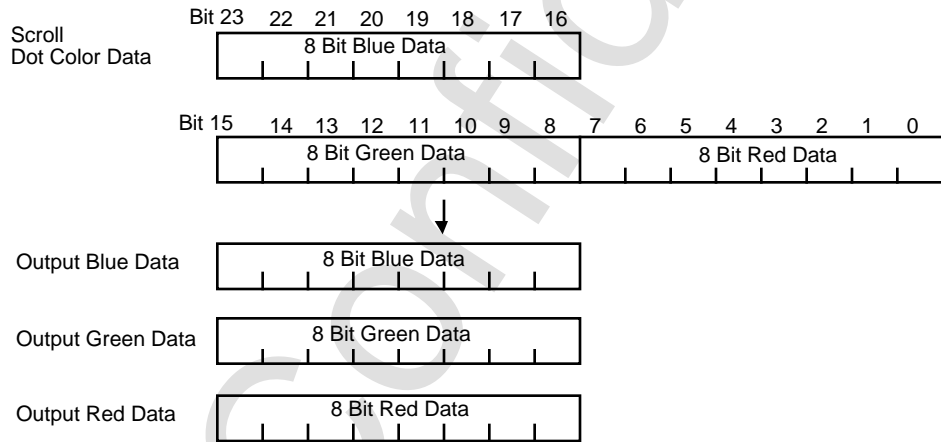

**Figure 10.6 RGB Format Scroll Dot Color Data**

### 10.3 Special Function Code

The special function, which performs in all scroll screens, has two functions: the special priority function, and the special color calculation function. When used in every dot, the dot color code that activates the special function can designate two special function code registers. Also, each scroll screen designates which of the two special function code registers will be used.

The special function code register has two 8-bit registers: special function code A, and special function code B. Each bit corresponds to two dot color code lower 4-bit values using the special function. The dot color code changes the bit number according to the character color count of each scroll screen. However, each bit of the special function code register will always correspond to the value of the lowest four bits of the dot color code. Moreover, the special function code is used only when the color format of scroll screen is the palette format.

See “11.2 Special Priority Function” and “12.2 Special Color Calculation Function” for using the special function. Figure 10.7 shows the dot color code that corresponds to special function code.

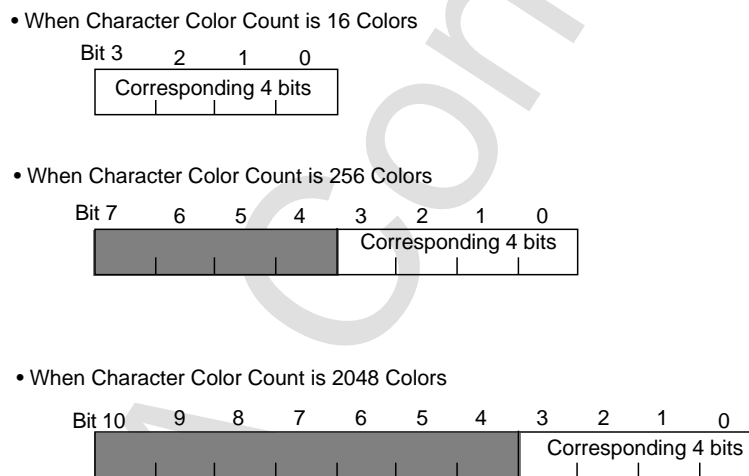

Figure 10.7 Dot Color Data Corresponding to Special Function Code



## Special Function Code Select Register

The special function code select register is a write-only 16-bit register that designates the special function code that activates all scroll screens. It is located at address 180024H. Because the value is cleared to 0 after power on or reset, it must be set.

	15	14	13	12	11	10	9	8
SFSEL	~	~	~	~	~	~	~	~
180024H	7	6	5	4	3	2	1	0
	~	~	~	R0SFCS	N3SFCS	N2SFCS	N1SFCS	N0SFCS

### Special function code select bit (N0SFCS, N1SFCS, N2SFCS, N3SFCS, R0SFCS)

Designates the special function code effecting every scroll screen.

N0SFCS	180024H	Bit 0	For NBG0 (or RBG1)
N1SFCS	180024H	Bit 1	For NBG1
N2SFCS	180024H	Bit 2	For NBG2
N3SFCS	180024H	Bit 3	For NBG3
R0SFCS	180024H	Bit 4	For RBG0

xxSFCS	Process
0	Enables special function code A
1	Enables special function code B

**Note:** N0, N1, N2, N3, or R0 is entered in bit name for xx.

## Special Function Code Register

The special function code register is a write-only 16-bit register that designates special function code A and special function code B. It is located at address 180026H. Because the value is cleared to 0 after power on or reset, it must be set.

	15	14	13	12	11	10	9	8
SFCODE	SFCDB7	SFCDB6	SFCDB5	SFCDB4	SFCDB3	SFCDB2	SFCDB1	SFCDB0
180026H	7	6	5	4	3	2	1	0
	SFCDA7	SFCDA6	SFCDA5	SFCDA4	SFCDA3	SFCDA2	SFCDA1	SFCDA0

### Special function code bit (SFCDA7 to SFCDA0, SFCDB7 to SFCDB0)

Designates special function codes A and B.

SFCDA7~SFCDA0	180026H	Bit 7~0	For Special Function Code A
SFCDB7~SFCDB0	180026H	Bit 15~8	For Special Function Code B

Bit Name	Dot Color Code
SFCDx0	When lower 4 bits of dot color code are, 0H or 1H
SFCDx1	When lower 4 bits of dot color code are, 2H or 3H
SFCDx2	When lower 4 bits of dot color code are, 4H or 5H
SFCDx3	When lower 4 bits of dot color code are, 6H or 7H
SFCDx4	When lower 4 bits of dot color code are, 8H or 9H
SFCDx5	When lower 4 bits of dot color code are, AH or BH
SFCDx6	When lower 4 bits of dot color code are, CH or DH
SFCDx7	When lower 4 bits of dot color code are, EH or FH

**Note:** A or B is entered in bit name x.

Settings	Process
0	Does not use special functions
1	Uses special functions

The special function code is used when mode 2 is designated in the special priority mode registers or when designating mode 2 in the special color calculation mode register. For more information see “11.2 Special Priority Function” or “12.2 Special Color Calculation Function.”





## Chapter 11 Priority Function

Introduction .....	224
11.1 Priority Function .....	224
Priority Number .....	224
Priority Number Register .....	225
11.2 Special Priority Function .....	227
Special Priority Mode Register .....	229
11.3 Insertion of Line Color Screen .....	230
Line Color Screen Enable Register .....	231

## Introduction

VDP2 compares the priority number values of sprites and scroll screens and decides the display priority order from the top three. The priority number of a sprite then selects each character from a maximum of eight values. The priority number of all scroll screens can also change the value of each dot and character by using the special priority function.

The line color screen can be inserted into the number two position, one below the screen, when the designated screen is at the highest priority.

### 11.1 Priority Function

The priority (display priority order) of sprites and scroll screens compares sizes of the values of the screen priority number without transparent dots positioned in the same TV screen coordinates for each dot. The screen priority increases as the value of the priority number increases. The top image is made of the highest priority dots; the second image is made of the second highest dots; and the third image is made of the third highest dots. All sprite and scroll screen dots display the back screen in the transparent position. Figure 11.1 shows the priority function.

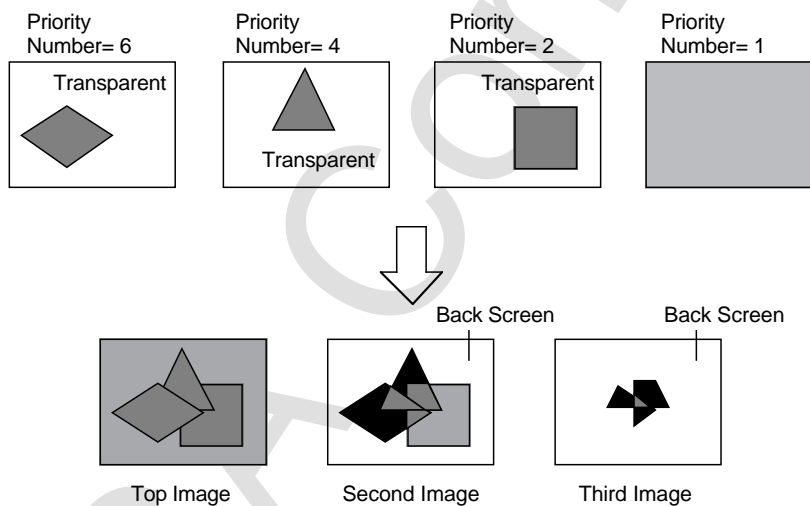

Figure 11.1 Priority Function

### Priority Number

The scroll screen has one 3-bit priority number register in each screen. This priority number normally is used in the entire surface, but can change the value of the least significant bit in each dot and character according to the special priority mode. The sprite priority number can select one of eight 3-bit priority number registers for each character. For information about selecting a sprite priority number register see “Priority Number Selection” in section “9.2 Priority and Color Calculation.”



Screen priority increases when the value of the priority number increases. When priority numbers are equal, they follow the order shown in Table 11.1. When the value of a priority number is OH, it is read as transparent.

**Table 11.1 Priority when the priority numbers are equal**

Priority	Normal	When inputting external image data	When displaying 2 screens of the rotation scroll screen	When inputting external images per 2 screens of the rotation scroll screen
Highest	Sprite	Sprite	Sprite	Sprite
:	RBG0	RBG0	RBG0	RBG0
:	NBG0	NBG0	RBG1	RBG1
:	NBG1	EXBG	-	EXBG
:	NBG2	NBG2	-	-
Lowest	NBG3	NBG3	-	-

### Priority Number Register

The priority number register designates the priority number. This is a write-only 16-bit register located at addresses 1800F8H to 1800FCH. Because the value is cleared to 0 after power on or reset, it must be set.

	15	14	13	12	11	10	9	8
PRINA	~	~	~	~	~	N1PRIN2	N1PRIN1	N1PRIN0
1800F8H	7	6	5	4	3	2	1	0
	~	~	~	~	~	N0PRIN2	N0PRIN1	N0PRIN0
	15	14	13	12	11	10	9	8
PRINB	~	~	~	~	~	N3PRIN2	N3PRIN1	N3PRIN0
1800FAH	7	6	5	4	3	2	1	0
	~	~	~	~	~	N2PRIN2	N2PRIN1	N2PRIN0
	15	14	13	12	11	10	9	8
PRIR	~	~	~	~	~	~	~	~
1800FCH	7	6	5	4	3	2	1	0
	~	~	~	~	~	R0PRIN2	R0PRIN1	R0PRIN0

**Priority number bit (for scroll screen) (N0PRIN2 to N0PRIN0, N1PRIN2 to N1PRIN0, N2PRIN2 to N2PRIN0, N3PRIN2 to N3PRIN0, R0PRIN2 to R0PRIN0)**

Designates the priority number of each screen scroll.

N0PRIN2~N0PRIN0	1800F8H	Bit 2~0	For NBG0 (or RBG1)
N1PRIN2~N1PRIN0	1800F8H	Bit 10~8	For NBG1 (or EXBG)
N2PRIN2~N2PRIN0	1800FAH	Bit 2~0	For NBG2
N3PRIN2~N3PRIN0	1800FAH	Bit 10~8	For NBG3
R0PRIN2~R0PRIN0	1800FCH	Bit 2~0	For RBG0

Larger priority numbers are given a higher display priority order. When the value of the priority number is 0, it is treated as transparent and not displayed. For more about priority number register of sprites, see “Priority Number Register” of “9.2 Priority and Color Calculation.”



## 11.2 Special Priority Function

The special priority function changes the least significant bit of the 3-bit priority number corresponding to every scroll screen in each character and dot. Using this function to change the priority of a portion of the scroll screen displays one surface as multiple screens. Furthermore, the least significant bit of the priority number changes only by the special priority function; the highest 2 bits are used with the register values. The special priority function has the following three modes.

1. Designates the least significant bit of the priority number in each screen
2. Designates the least significant bit of the priority number in each character
3. Designates the least significant bit of the priority number in each dot

When designating the least significant bit of the priority number in each screen, the value of the priority number register in each scroll screen is used unchanged.

When designating each character, the value of a special priority bit within pattern name data is used as the least significant bit of the priority number. For more information about special priority bits, see "4.6 Pattern Name Table (Page)."

When designating each dot in character patterns designating 1 (the special priority bit within pattern name data), only dots that coincide with the dot color code are designated in the special function code. The least significant bit of the priority number is set to 1, the rest are fixed at 0. Do not set this mode when the color format of scroll screen is RGB. For more about the dot color code see "10.3 Special Function Code."

When the 3-bit priority number value obtained by the special priority function is OH, that screen, character, or dots are treated as transparent. Table 11.2 shows the special priority function by mode.

**Table 11.2 Special priority function by mode**

Special Priority Mode	Special Priority Selection	Color Format	Priority Number LSB Value
Mode 0	Selected per each screen	Palette Format or RGB Format	Priority number register LSB value
Mode 1	Select per each character	Palette Format or RGB Format	Value of the special priority bit in the pattern name data
Mode 2	Setting not allowed	Palette Format	When the special priority bit in the pattern name data is equal to one, only the dot coinciding with the dot color code selected for special function code becomes 1, while the rest become 0.
		RGB Format	Setting Invalid

When the display format designates mode 1 or 2 in the scroll screen of the bit map format, it is not the special priority bit within the pattern name data, but the special priority bit of the bit map palette number register that is used.



## Special Priority Mode Register

The special priority mode register is a write-only 16-bit register that designates the mode of the special priority function corresponding to each scroll screen, and is located at address 1800EA. Because the value clears to 0 after power on or reset, it must be set.

	15	14	13	12	11	10	9	8
SFPRMD	~	~	~	~	~	~	R0SPRM1	R0SPRM0
1800EAH	7	6	5	4	3	2	1	0
	N3SPRM1	N3SPRM0	N2SPRM1	N2SPRM0	N1SPRM1	N1SPRM0	N0SPRM1	N0SPRM0

### Special priority mode bit (N0SPRM1, N0SPRM0, N1SPRM1, N1SPRM0, N2SPRM1, N2SPRM0, N3SPRM1, N3SPRM0, R0SPRM1, R0SPRM0)

Designates the special priority function mode of each screen scroll.

N0SPRM1, N0SPRM0	1800EAH	Bit 1,0	For NBG0 (or RBG1)
N1SPRM1, N1SPRM0	1800EAH	Bit 3,2	For NBG1 (or EXBG)
N2SPRM1, N2SPRM0	1800EAH	Bit 5,4	For NBG2
N3SPRM1, N3SPRM0	1800EAH	Bit 7,6	For NBG3
R0SPRM1, R0SPRM0	1800EAH	Bit 9,8	For RBG0

xxSPRM1	xxSPRM0	Mode	Process
0	0	Mode 0	Select the priority number LSB per each screen
0	1	Mode 1	Select the priority number LSB per each character
1	0	Mode 2	Select the priority number LSB per each dot
1	1	-	Selection not allowed

**Note:** N0, N1, N2, N3, or R0 is entered in bit name for xx.

Do not set mode 2 when the scroll screen color format is the RGB mode.  
Do not set in EXBG any other mode but 0.  
Character or dot in which priority number is 0 is considered transparent.

### 11.3 Insertion of Line Color Screen

The line color screen does not have a priority number register; it forcefully inserts the top image as the second image, and calculates color. Meanwhile, the original second image becomes the new third image, and the old third image becomes the fourth image. Figure 11.2 shows insertion of the line color screen.

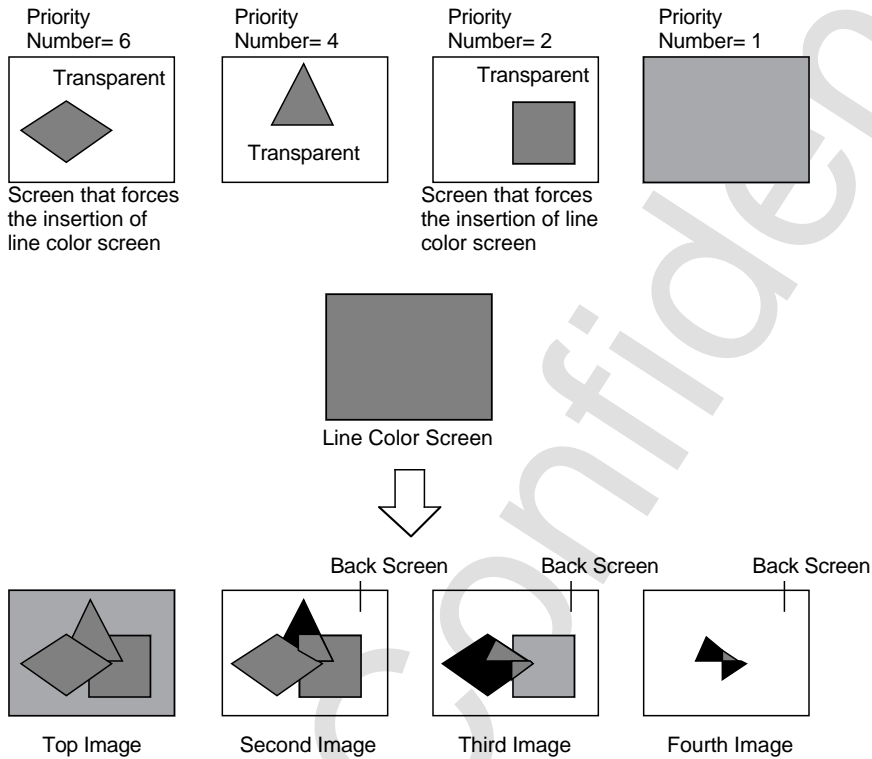

Figure 11.2 Line Color Screen Insertion





## Line Color Screen Enable Register

The line color screen enable register designates whether to insert the line color screen when each screen is a top image. This is a write-only 16-bit register located at address 1800E8H. Because the value is cleared to 0 after power on or reset, you must set it.

	15	14	13	12	11	10	9	8
LNLCEN	~	~	~	~	~	~	~	~
1800E8H	7	6	5	4	3	2	1	0
	~	~	SPLCEN	R0LCEN	N3LCEN	N2LCEN	N1LCEN	N0LCEN

### Line color enable bit (N0LCEN, N1LCEN, N2LCEN, N3LCEN, R0LCEN, SPLCEN)

Designates whether to insert the line color screen when each screen is a top image.

N0LCEN	1800E8H	Bit 0	For NBG0 (or RBG1)
N1LCEN	1800E8H	Bit 1	For NBG1 (or EXBG)
N2LCEN	1800E8H	Bit 2	For NBG2
N3LCEN	1800E8H	Bit 3	For NBG3
R0LCEN	1800E8H	Bit 4	For RBG0
SPLCEN	1800E8H	Bit 5	For Sprite

xxLCEN	Process
0	Does not insert the line color screen when corresponding screen is top image
1	Inserts the line color screen when corresponding screen is top image

**Note:** N0, N1, N2, N3, R0, or SP is entered in the bit name for xx.

A line color screen is inserted only in the second image section of the screen designated for insertion, thus becoming the top image. Sprites can only be designated in their entirety. To designate each character, they must be controlled by their color calculation ratio value. This register cannot be used at the same time as the gradation calculation function.

(This is page was blank in the original Japanese document)

SEGA Confidential



## Chapter 12 Color Calculations

Introduction .....	234
12.1 Color Calculation Function .....	234
Normal Color Calculation .....	234
Extended Color Calculation Function .....	236
12.2 Gradation Calculation Function .....	238
Color Calculation Control Register .....	240
Color Calculation Ratio Register .....	243
12.3 Special Color Calculation Function .....	245
Special Color Calculation Mode Register .....	247

## Introduction

VDP2 calculates, by a designated ratio, color data of second and top images obtained comparing priorities of sprite and each scroll screen. The sprite and color calculation ratio can select each character from one of eight values. The color calculation enable of every scroll screen can designate each character and dot by using the special color calculation function.

With the second and third images at a fixed ratio, the colors of up to four screens can be calculated by doing color calculations in the second image. In addition, distant backgrounds can be shaded causing the gradation calculation function to be enabled.

### 12.1 Color Calculation Function

The color calculation function calculates with a ratio designating the top and second images (or three images, the second image, third image, fourth image, images calculated at a set ratio) by individual RGB color, and is able to produce an effect of overlapping a group of semi-transparent screens. The color calculation function is shown in Figure 12.1.

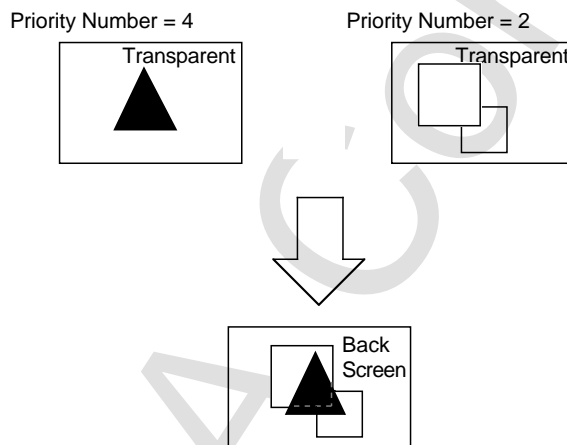

Figure 12.1 Color calculation function

#### Normal Color Calculation

There are two types of modes when calculating color by the top and second images:

1. Top and second images add according to the value of the color calculation ratio.
2. Top and second images add by the value unchanged.



The value of the color calculation ratio of each screen is designated in the register when using the color calculation mode to add in proportion to the value of color calculation ratio. The color calculation ratio of the sprite can designate one register from a maximum of eight for each character; the scroll screen color calculation ratio designates to the register of each screen. For more about sprite color calculation ratio see "Color Calculation Ratio Register" in "9.2 Priority and Color Calculation." The color calculation ratio of each screen is designated by 5 bits, and a total of 32 steps: top image : second image = 31 : 1 to 0 : 32 can be selected. There are two kinds of modes for designating the value of that ratio.

1. Designates by the top image
2. Designates by the second image

When designating with the top image, the sprite that becomes the top image or the color calculation ratio value of the scroll screen is used without any relation to the second image screen. When designating with the second image, the color calculation ratio can be changed by the screen of the second image. The sprite, scroll screen values, line color screen, and back screen color calculation ratio values can be used.

When using the color calculation mode to add by the value, gradually rewrite from the top image color data from 00H to the original color to create a fade-in effect of the top image over the second image. Be aware that doing so may result in color that is concurrent with fade-in becoming brighter than the original. Addition results that exceed FFH are treated as FFH. Figure 12.2 shows the color calculation ratio mode.

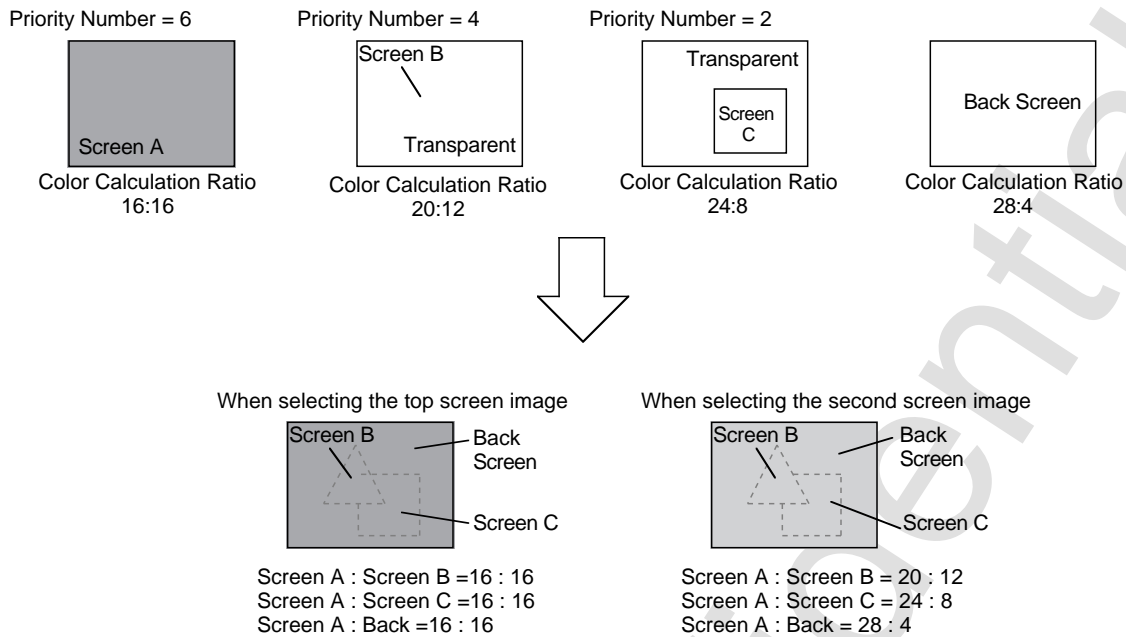

**Figure 12.2 Color calculation ratio mode**

There is no limitation in calculating color when the TV screen mode is the Normal mode. But when the TV screen mode is the high resolution mode or Exclusive monitor mode, the color RAM mode and second image color format have limitations. Table 12.1 shows limitations of the color calculation function.

**Table 12.1 Color calculation function when in the high resolution mode or special monitor mode**

Color RAM Mode	Second Image Color Format	Color Calculation Function
Mode 0	Palette format or RGB format	Can be used
Mode 1	Palette format	Cannot be used
	RGB format	Can be used
Mode 2	Palette format	Cannot be used
	RGB format	Can be used

### Extended Color Calculation Function

The extended color calculation function makes second image data of the result of the second and third images calculated by a fixed ratio. Calculating the color of the second and top images makes possible three screen color calculation. Inserting a line color screen creates third image data resulting from color calculation of the third and fourth images calculated by a fixed ratio, and makes second image data by adding the third image and line color data calculated by a fixed ratio. Therefore, four screen color calculation is possible. The extended color calculation function can be used only when in the TV screen mode is the Normal mode.



When performing extended color calculation, whether to add the third and fourth images complies with the screen color calculation enable bit of the third image screen, and whether to add the second and third images complies with the color calculation enable bit of the second image screen.

When the extended color calculation function is used, the extended color calculation ratio changes according to the color RAM mode, the line color screen insertion, the color calculation enable bit value of second and third images and color format, and the color format of the fourth image.

Figure 12.3 shows the extended color calculation function; Table 12.2 shows the extended color calculation ratios.

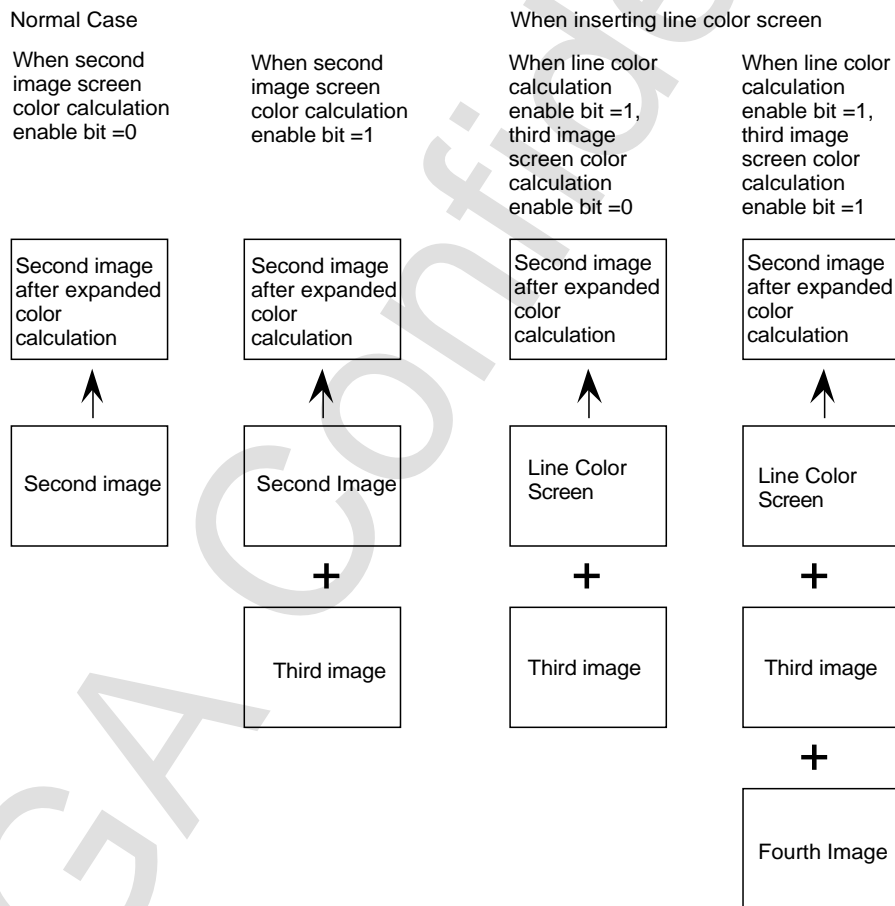

Figure 12.3 Extended Color Calculation Function

**Table 12.2 Extended Color Calculation Ratio**

Color RAM Mode	Line Color Screen	Color Format			Color Calculation Enable Bit Value		Extended Color Calculation Ratio
		2nd Image	3rd Image	4th Image	2nd Image	3rd Image	
Mode 0	Does not Insert	Palette or RGB format	Palette or RGB format	-	0	-	4:0:0
					1	-	2:2:0
	Inserts	-	Palette or RGB format	Palette or RGB format	0	0 or 1	4:0:0
					1	0	2:2:0
Mode 1 or Mode 2	Does not Insert	Palette or RGB format	Palette format	-	0 or 1	-	4:0:0
			RGB format	-	0	-	4:0:0
	Inserts	-	Palette format	Palette or RGB format	0 or 1	0 or 1	4:0:0
					0	0 or 1	4:0:0
			RGB format	Palette format	1	0 or 1	2:2:0
					0	0 or 1	4:0:0
					1	0	2:2:0
					1	1	2:1:1

**Note:** The extended color calculation function cannot be used when the TV screen mode in is the high-resolution or Exclusive monitor mode. When inserting the line color screen, the color format of the second image becomes the palette format. The extended color calculation ratio is for a value that is 1/4 times the individual RGB data.

## 12.2 Gradation Calculation Function

The gradation calculation function calculates the horizontal color data of the designated one screen by a fixed ratio, and can create a gradation effect of the distant background. This function can only be used when the TV screen mode is the Normal mode, and the color RAM mode is mode 0. Gradation Calculation adds color data of a designated screen for values 1/4 times that of individual RGB by the ratio below.

(2 dots left display coordinates : (1 dot left display coordinates : (display coordinates = 1:1:2 color data) color data) color data)

Here, the added results of the area in which the designated screen becomes the top or second images is forced to be the second image. By calculating color of the second and top images, it is possible to display pictures in which gradation calculations have been done. The second image of the area, in which the gradation calculation designated screen is not a top or second image, becomes the image determined by normal priority.





Screens using gradation calculation have no transparent dots. If gradation calculation is performed for screens having transparent dots, correct calculation cannot be done by that boundary. If the gradation calculation function is used, it is not possible to insert the line color screen. In addition, the extended color calculation function can no longer be used. Figure 12.4 shows the gradation calculation function.

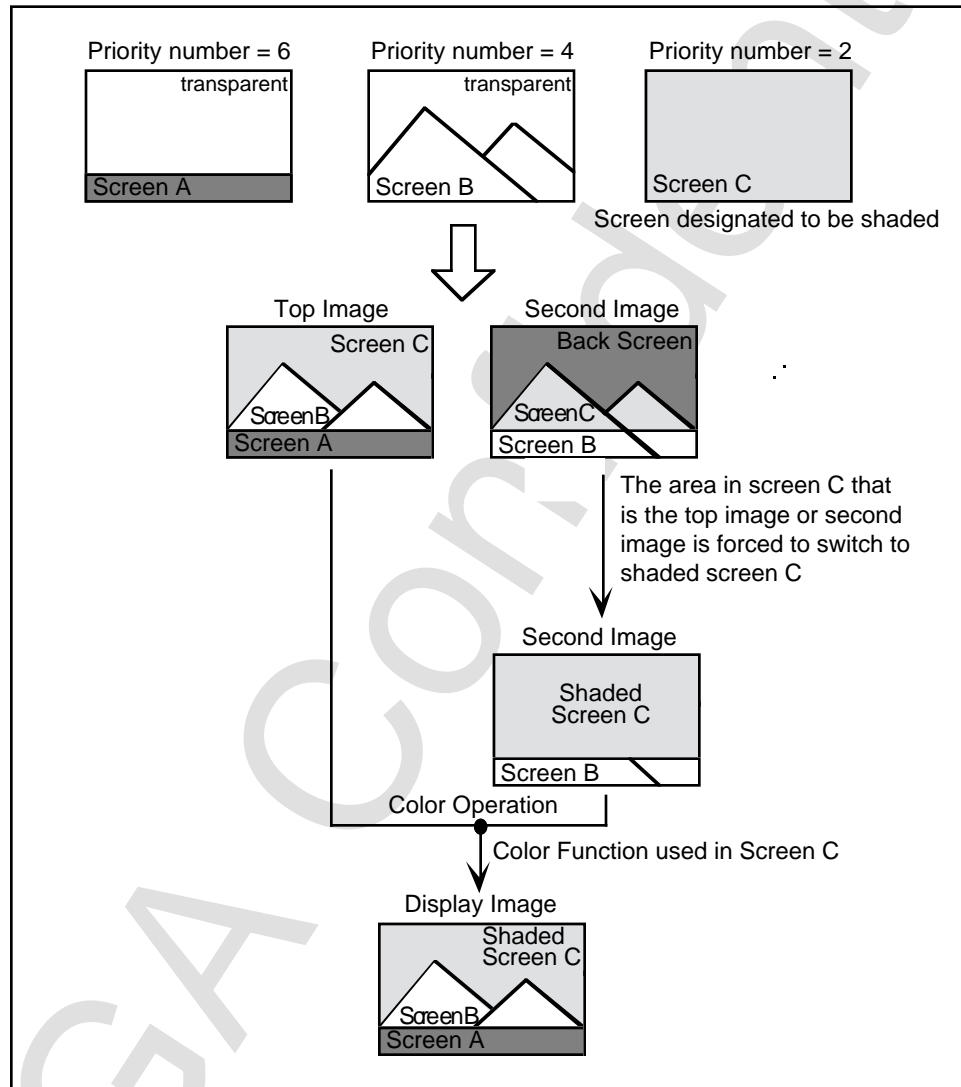

Figure 12.4 Gradation Calculation Function

## Color Calculation Control Register

The color calculation control register is a write-only 16-bit register that controls color calculation, and is located at address 1800ECH. Because the value is cleared to 0 after power on or reset, the value must be set.

	15	14	13	12	11	10	9	8
1800ECH	BOKEN	BOKN2	BOKN1	BOKN0	~	EXCCEN	CCRTMD	CCMD
	7	6	5	4	3	2	1	0
	~	SPCCEN	LCCEN	ROCCEN	N3CCEN	N2CCEN	N1CCEN	NOCCEN

### Gradation enable bit (BOKEN), bit 15

Determines whether to use the gradation function.

BOKEN	Process
0	Do not use gradation calculation function
1	Use gradation calculation function

If this bit is 1, the extended color calculation function can no longer be used. The gradation calculation function can only be used when the TV screen mode is the Normal mode, and the color RAM mode is mode 0.

### Gradation screen number bit: Gradation number bit (BOKN2 to BOKN0), bits 14 to 12

Designates the screen using the gradation (shading) calculation function.

BOKN2	BOKN1	BOKN0	Screen Using Gradation Calculation Function
0	0	0	Sprite
0	0	1	RBG0
0	1	0	NBG0 or RBG1
0	1	1	Invalid
1	0	0	NBG1 or EXBG
1	0	1	NBG2
1	1	0	NBG3
1	1	1	Invalid

### Extended color calculation enable bit (EXCCEN), bit 10

Determines whether to use the extended color calculation function.



EXCCEN	Process
0	Do not use extended color calculation
1	Use extended color calculation

The above calculation function cannot be used at the same time as the gradation calculation function. When the BOKEN bit is 1, this bit is ignored. The extended color calculation function can only be used when in the TV screen and Normal modes, and cannot be used when in the high-resolution mode or Exclusive monitor mode.

**Color calculation ratio mode bit (CCRTMD), bit 9**

Designates the color calculation ratio mode.

CCRTMD	Mode	Process
0	0	For color calculation ratio, select per top screen side
1	1	For color calculation ratio, select per second screen side

The top image always designates whether to perform normal color calculation.

**Color calculation mode bit (CCMD), bit 8**

Designates the color calculation mode.

CCMD	Mode	Process
0	0	Add according to the color calculation register value
1	1	Add as is

When in mode 1, the values of the color calculation ratio registers of each screen are ignored.

SEGA CONFIDENTIAL

**Color calculation enable bit (N0CCEN, N1CCEN, N2CCEN, N3CCEN, R0CCEN, LCCEN, SPCEN)**

Designates whether to perform color calculation (color calculation enable)

N0CCEN	1800ECH	Bit 0	For NBG0 (or RBG1)
N1CCEN	1800ECH	Bit 1	For NBG1 (or EXBG)
N2CCEN	1800ECH	Bit 2	For NBG2
N3CCEN	1800ECH	Bit 3	For NBG3
R0CCEN	1800ECH	Bit 4	For RBG0
LCCEN	1800ECH	Bit 5	For LNCL
SPCEN	1800ECH	Bit 6	For Sprite

xxCCEN	Process
0	Does not color-calculate
1	Color-calculates

**Note:** N0, N1, N2, N3, R0, LC, or SP is entered in bit name for xx.

When calculating color between the top and second images, calculation is controlled by the color calculation enable bit of the top image. When using the extended color calculation function, control between the second and third images is done by the color calculation enable bit of the second image, and control between the third and fourth images is done by the color calculation enable bit of the third image.



## Color Calculation Ratio Register

The color calculation ratio register is a write-only 16-bit register that designates the color calculation ratio, and is located at addresses 180108H to 18010EH. Because the value is cleared to 0 after power on or reset, the value must be set.

	15	14	13	12	11	10	9	8
CCRNA	~	~	~	N1CCRT4	N1CCRT3	N1CCRT2	N1CCRT1	N1CCRT0
180108H	7	6	5	4	3	2	1	0
	~	~	~	N0CCRT4	N0CCRT3	N0CCRT2	N0CCRT1	N0CCRT0
	15	14	13	12	11	10	9	8
CCRN B	~	~	~	N3CCRT4	N3CCRT3	N3CCRT2	N3CCRT1	N3CCRT0
18010AH	7	6	5	4	3	2	1	0
	~	~	~	N2CCRT4	N2CCRT3	N2CCRT2	N2CCRT1	N2CCRT0
	15	14	13	12	11	10	9	8
CCRR	~	~	~	~	~	~	~	~
18010CH	7	6	5	4	3	2	1	0
	~	~	~	R0CCRT4	R0CCRT3	R0CCRT2	R0CCRT1	R0CCRT0
	15	14	13	12	11	10	9	8
CCRLB	~	~	~	BKCCRT4	BKCCRT3	BKCCRT2	BKCCRT1	BKCCRT0
18010EH	7	6	5	4	3	2	1	0
	~	~	~	LCCRT4	LCCRT3	LCCRT2	LCCRT1	LCCRT0

**Color calculation ratio bit (for scroll screens): (N0CCRT4 to N0CCRT0, N1CCRT4 to N1CCRT0, N2CCRT4 to N2CCRT0, N3CCRT4 to N3CCRT0, R0CCRT4 to R0CCRT0, LCCRT4 to LCCRT0, BKCCRT4 to BKCCRT0)**

Designates the color calculation ratio of each scroll screen. The color calculation ratio corresponds to a value 1/32 times R,G,B color data.

N0CCRT4~N0CCRT0	180108H	Bit 4~0	For NBG0 (or RBG1)
N1CCRT4~N1CCRT0	180108H	Bit 12~8	For NBG1 (or EXBG)
N2CCRT4~N2CCRT0	18010AH	Bit 4~0	For NBG2
N3CCRT4~N3CCRT0	18010AH	Bit 12~8	For NBG3
R0CCRT4~R0CCRT0	18010CH	Bit 4~0	For RBG0
LCCRT4~LCCRT0	18010EH	Bit 4~0	For LNCL
BKCCRT4~BKCCRT0	18010EH	Bit 12~8	For Back

xxCCRT4	xxCCRT3	xxCCRT2	xxCCRT1	xxCCRT0	Color Calculation Ratio Top Image : Second Image
0	0	0	0	0	31:1
0	0	0	0	1	30:2
0	0	0	1	0	29:3
0	0	0	1	1	28:4
0	0	1	0	0	27:5
0	0	1	0	1	26:6
0	0	1	1	0	25:7
0	0	1	1	1	24:8
0	1	0	0	0	23:9
0	1	0	0	1	22:10
0	1	0	1	0	21:11
0	1	0	1	1	20:12
0	1	1	0	0	19:13
0	1	1	0	1	18:14
0	1	1	1	0	17:15
0	1	1	1	1	16:16
1	0	0	0	0	15:17
1	0	0	0	1	14:18
1	0	0	1	0	13:19
1	0	0	1	1	12:20
1	0	1	0	0	11:21
1	0	1	0	1	10:22
1	0	1	1	0	9:23
1	0	1	1	1	8:24
1	1	0	0	0	7:25
1	1	0	0	1	6:26
1	1	0	1	0	5:27
1	1	0	1	1	4:28
1	1	1	0	0	3:29
1	1	1	0	1	2:30
1	1	1	1	0	1:31
1	1	1	1	1	0:32

**Note:** N0, N1, N2, N3, R0, LC, or BK is entered in bit name for xx.

For more about the color calculation ratio register of sprites see “Color Calculation Ratio Register” in “9.2 Priority and Color Calculation.”

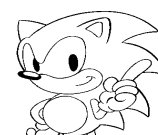

## 12.3 Special Color Calculation Function

The special color calculation function designates the color calculation enable not only by the entire screen but by character units and dot units. See the four modes below.

1. Color calculation enable designates each screen.
2. Color calculation enable designates each character.
3. Color calculation enable designates each dot.
4. Color calculation enable designates by the most significant bit of color data.

When designating color calculation enable for each screen, color calculation is performed when the color calculation enable bit value in the color calculation control register that corresponds to each scroll screen is 1.

When designating each character in a scroll screen that the color calculation enable bit has designated 1, color calculation is performed only in character patterns of a special color calculation bit value of 1 in pattern name data. For more about the special color calculation bit in pattern name data see "4.6 Pattern Name Table."

When designating each dot, color calculation is performed only in dots that agree with the dot color code designated in the special function code, and in the character pattern designated 1 in which the value of the special color calculation bit within the pattern name data of the scroll screen has a color calculation enable bit of 1. Do not set this mode when the color format of the scroll screen is the RGB format. For more about the special function code see "10.3 Special Function Code."

When designating with the most significant bit of color data, color calculation is performed only in dots that used color data when the most significant bit is set at 1, and when the scroll screen where the color calculation enable bit is designated 1 is in a palette format. Color calculation will always be performed if this mode is designated when the scroll screen, where the color calculation enable bit is designated 1, is in the RGB format.

When mode 1 or 2 is designated in a bit map format scroll screen, the special color calculation bit of the bit map number register is used, not the special color calculation bit within pattern name data. Table 12.3 shows the special color calculation mode.

**Table 12.3 Special Color Calculation Mode**

Special Color Calculation Mode	Special Color Calculation Selection	Color Format	Color Calculation Enable Condition
Mode 0	Select per screen	Palette format or RGB format	Color calculation enable bit = 1
Mode 1	Select per character	Palette format or RGB format	Color calculation bit = 1 and pattern name data special color calculation bit = 1
Mode 2	Select per dot	Palette format	Color calculation bit = 1 and pattern name data special color calculation bit = 1 and The dot that matches dot color code selected per special function code
		RGB format	Invalid
Mode 3	Select with color data MSB	Palette format	Color calculation bit = 1 and The dot using color data where MSB = 1
		RGB format	Color calculation enable bit = 1

The special color calculation mode can designate only for top images. Otherwise, it is fixed at 0.





## Special Color Calculation Mode Register

The special color calculation mode register is a write-only 16-bit register that designates the special color calculation function mode for each scroll screen, and is located at address 1800EEH. Because the value is cleared to 0 after power on or reset, you must set the value.

	15	14	13	12	11	10	9	8
SFCCMD	~	~	~	~	~	~	R0SCCM1	R0SCCM0
1800EEH	7	6	5	4	3	2	1	0
	N3SCCM1		N3SCCM0		N2SCCM1		N2SCCM0	
	N1SCCM1		N1SCCM0		N0SCCM1		N0SCCM0	

### Special color calculation mode bit (N0SCCM1, N0SCCM0, N1SCCM1, N1SCCM0, N2SCCM1, N2SCCM0, N3SCCM1, N3SCCM0, R0SCCM1, R0SCCM0)

Designates the special color calculation function mode of each scroll screen.

N0SCCM1, N0SCCM0	1800EEH	Bit 1,0	For NBG0 (or RBG1)
N1SCCM1, N1SCCM0	1800EEH	Bit 3,2	For NBG1 (or EXBG)
N2SCCM1, N2SCCM0	1800EEH	Bit 5,4	For NBG2
N3SCCM1, N3SCCM0	1800EEH	Bit 7,6	For NBG3
R0SCCM1, R0SCCM0	1800EEH	Bit 9,8	For RBG0

xxSCCM1	xxSCCM0	Mode	Process
0	0	0	Select color calculation enable per screen
0	1	1	Select color calculation enable per character
1	0	2	Select color calculation enable per dot
1	1	3	Select color calculation enable with color data MSB

**Note:** N0, N1, N2, N3, or R0 is entered in bit name for xx.

Special color calculation mode designation is effective only when each screen is a top image. Otherwise, the mode must be set at 0. When the color format of scroll screen is the RGB format, do not fixed at mode 2. Color is calculated by all dots when mode 3 has been designated. Finally, do not designate modes 1 and 2 in EXBG.

(This page was blank in the original Japanese document)

SEGA Confidential



## Chapter 13 Color Offset Function

Introduction .....	250
13.1 Color Offset Selection .....	250
Color Offset Enable Register .....	251
Color Offset Select Register .....	252
Color Offset Register .....	253

## Introduction

The color offset function causes a change in the screen color without changing color RAM data by adding the offset value when sprite and data of each screen are output. Can also be used for fade-in and fade-out.

### 13.1 Color Offset Selection

The color offset value can set two values, color offset A and color offset B in each RGB, and can designate which of the two values to use for each screen. The color offset value is 9-bit data corresponding to individual RGB. When resulting color data added to individual RGB is smaller than 00H, the data is treated as 00H; when larger than FFH, the data is treated as FFH.

Because the color offset function process follows the color calculation function process, the color offset value is added to the color data resulting from color calculations. In addition, because the result screen of color calculation is treated as the top image screen, designation of the color offset enable register is done with the screen bit of that top image. Figure 13.1 shows the color offset data.



Figure 13.1 Color Offset Data



## Color Offset Enable Register

The color offset enable register is a write-only 16-bit register that designates whether to use the color offset function for each screen, and is located at address 180110H. Because the value is cleared to 0 after power on or reset, it must be set.

	15	14	13	12	11	10	9	8
CLOFEN	~	~	~	~	~	~	~	~
180110H	7	6	5	4	3	2	1	0
	~	SPCOEN	BKCOEN	R0COEN	N3COEN	N2COEN	N1COEN	N0COEN

### Color offset enable bit (N0COEN, N1COEN, N2COEN, N3COEN, R0COEN, BKCOEN, SPCOEN)

Designates whether to use the color offset function.

N0COEN	180110H	Bit 0	For NBG0 (or RBG1)
N1COEN	180110H	Bit 1	For NBG1 (or EXBG)
N2COEN	180110H	Bit 2	For NBG2
N3COEN	180110H	Bit 3	For NBG3
R0COEN	180110H	Bit 4	For RBG0
BKCOEN	180110H	Bit 5	For Back
SPCOEN	180110H	Bit 6	For Sprite

xxCOEN	Process
0	Do not use color offset function
1	Use color offset function

**Note:** N0, N1, N2, N3, R0, BK, or SP is entered in bit name for xx.

Using the color calculation function designates the color offset enable bit of the top image screen.

## Color Offset Select Register

The color offset select register designates the color offset register used for each screen. This is a write-only 16-bit register located at address 180112H. Because the value is cleared to 0 after power on or reset, it must be set.

	15	14	13	12	11	10	9	8
CLOFSL	~	~	~	~	~	~	~	~
180112H	7	6	5	4	3	2	1	0
	~	SPCOSL	BKCOLS	R0COLS	N3COLS	N2COLS	N1COLS	N0COLS

### Color offset select bit (N0COLS, N1COLS, N2COLS, N3COLS, R0COLS, BKCOLS, SPCOSL)

Designates the color offset register to use when using the color offset function.

N0COLS	180112H	Bit 0	For NBG0 (or RBG1)
N1COLS	180112H	Bit 1	For NBG1 (or EXBG)
N2COLS	180112H	Bit 2	For NBG2
N3COLS	180112H	Bit 3	For NBG3
R0COLS	180112H	Bit 4	For RBG0
BKCOLS	180112H	Bit 5	For Back
SPCOSL	180112H	Bit 6	For Sprite

xxCOLS	Process
0	Use color offset A value
1	Use color offset B value

**Note:** N0, N1, N2, N3, R0, BK, or SP is entered in bit name for xx.

When using the color calculation function, designates with the color offset select bit of the top image screen.



## Color Offset Register

The color offset register is a write-only 16-bit register that designates RGB individual values of the color offset value, and is located at addresses 180114H to 18011EH. Because the value is cleared to 0 after power on or reset, it must be set.

COAR 180114H	15	14	13	12	11	10	9	8
	~	~	~	~	~	~	~	COARD8
	7	6	5	4	3	2	1	0
	COARD7	COARD6	COARD5	COARD4	COARD3	COARD2	COARD1	COARD0
COAG 180116H	15	14	13	12	11	10	9	8
	~	~	~	~	~	~	~	COAGR8
	7	6	5	4	3	2	1	0
	COAGR7	COAGR6	COAGR5	COAGR4	COAGR3	COAGR2	COAGR1	COAGR0
COAB 180118H	15	14	13	12	11	10	9	8
	~	~	~	~	~	~	~	COABL8
	7	6	5	4	3	2	1	0
	COABL7	COABL6	COABL5	COABL4	COABL3	COABL2	COABL1	COABL0
COBR 18011AH	15	14	13	12	11	10	9	8
	~	~	~	~	~	~	~	COBRD8
	7	6	5	4	3	2	1	0
	COBRD7	COBRD6	COBRD5	COBRD4	COBRD3	COBRD2	COBRD1	COBRD0
COBG 18011CH	15	14	13	12	11	10	9	8
	~	~	~	~	~	~	~	COBGR8
	7	6	5	4	3	2	1	0
	COBGR7	COBGR6	COBGR5	COBGR4	COBGR3	COBGR2	COBGR1	COBGR0
COBB 18011EH	15	14	13	12	11	10	9	8
	~	~	~	~	~	~	~	COBBL8
	7	6	5	4	3	2	1	0
	COBBL7	COBBL6	COBBL5	COBBL4	COBBL3	COBBL2	COBBL1	COBBL0

**Color offset value bit: Color offset data bit (COARD8 to COARD0, COAGR8 to COAGR0, COABL8 to COABL0, COBRD8 to COBRD0, COBGR8 to COBGR0, COBBL8 to COBBL0)**

Sets the RGB individual value of color offset A and B. Negative numbers should be set by two's- complement values.

COARD8~COARD0	180114H	Bit 8~0	For color offset A RED data
COAGR8~COAGR0	180116H	Bit 8~0	For color offset A GREEN data
COABL8~COABL0	180118H	Bit 8~0	For color offset A BLUE data
COBRD8~COBRD0	18011AH	Bit 8~0	For color offset B RED data
COBGR8~COBGR0	18011CH	Bit 8~0	For color offset B GREEN data
COBBL8~COBBL0	18011EH	Bit 8~0	For color offset B BLUE data

SEGA Confidential





## Chapter 14 Shadow Function

Introduction .....	256
14.1 Shadow Process .....	256
Normal Shadow .....	256
MSB Shadow .....	258
Shadow Control Register .....	259

## Introduction

This function projects a shadow on a sprite or scroll screen by using a sprite. There are two types of sprite shadows: the Normal shadow and the MSB shadow. The MSB shadow is used when the sprite is type 2 through 7, and is used when the sprite shadow priority is highest. The shadow function is processed after the color calculation and color offset functions. The shadow function is shown in Figure 14.1.

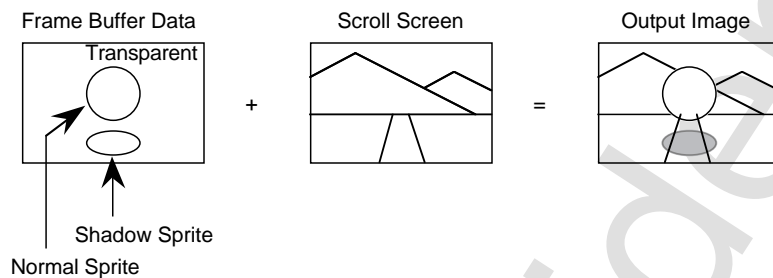

Figure 14.1 Shadow Function

## 14.1 Shadow Process

When the sprite priority of the Normal shadow or MSB shadow is highest, the shadow process makes the sprite transparent and divides in half the brightness of the part of the sprite in the top image.

### Normal Shadow

With Normal shadow sprite, the number of bits to be determined by the sprite type changes with dot color data of the least significant bit in the designated sprite type at 0, and all other dot color data at 1.

Sprite data of a Normal shadow designates the color control word such that all bits of dot color data remaining from the dot color code are 1, with only the least significant bit at 0. Also, sprite data of a Normal shadow is created by writing sprite characters of the dot color code whose remaining bits are 1 to the frame buffer. In Figure 14.1, a shadow cannot be projected because it has already been directed to the frame buffer. As a result, write to the frame buffer first. For more about color control word, see "VDP1 User's Manual."

The scroll screen and back screen, which project a shadow by the Normal shadow sprite, can designate in all screens.



A Normal shadow is shown in Figure 14.2 and sprite data of a Normal shadow is shown in Figure 14.3.

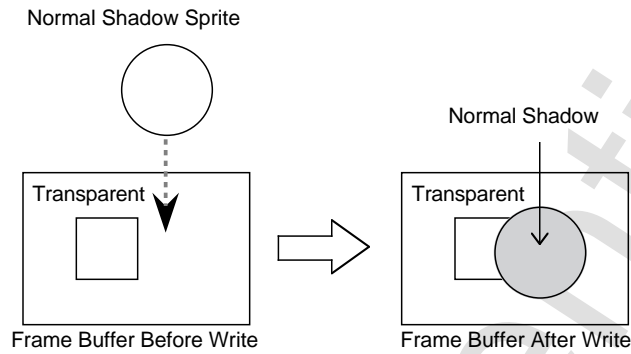

**Figure 14.2 Sprite data write of a Normal shadow**

- When Sprite Type 0~3, 5

Bit 15	14	13	12	11	10	9	8	7	6	5	4	3	2	1	0
						1	1	1	1	1	1	1	1	1	0

- When Sprite Type 4, 6

Bit 15	14	13	12	11	10	9	8	7	6	5	4	3	2	1	0
						1	1	1	1	1	1	1	1	1	0

- When Sprite Type 7

Bit 15	14	13	12	11	10	9	8	7	6	5	4	3	2	1	0
						1	1	1	1	1	1	1	1	1	0

- When Sprite Type C~F

Bit 15	14	13	12	11	10	9	8	7	6	5	4	3	2	1	0
								1	1	1	1	1	1	1	0

- When Sprite Type 8

Bit 15	14	13	12	11	10	9	8	7	6	5	4	3	2	1	0
									1	1	1	1	1	1	0

- When Sprite Type 9~B

Bit 15	14	13	12	11	10	9	8	7	6	5	4	3	2	1	0
										1	1	1	1	1	0

Note: The bits in the shaded areas are used in judging the normal shadow.

**Figure 14.3 Sprite data of a Normal shadow**

## MSB Shadow

MSB shadow is enabled only when sprite types are type 2 through 7, with sprite data MSB at 1. Depending on the value of 15 bits other than MSB, there are two types of shadow: sprite shadow and the transparent shadow. The sprite shadow MSB is 1 and all the values of 15 bits, other than the MSB, not 0. The transparent shadow MSB is 1, with all the values of 15 bits, other than the MSB, at 0. When dot color data satisfies Normal shadow conditions, it is judged to be a Normal shadow even if sprite shadow conditions are satisfied.

MSB shadow sprite data is created by changing only MSB to 1 in the form of an MSB shadow sprite for frame buffer data that the VDP1 has already written to. (See "MSB On" in the "VDP1 User's Manual.") A shadow is added to the sprite character when all frame buffer data bits before the MSB changes are not 0; i.e., when a normal sprite that has already been written becomes a sprite shadow.

A shadow is added for a scroll screen priority that is one less than the sprite of the transparent shadow when all frame buffer data bits before the MSB is changed are 0; i.e., a transparent shadow will result when transparent. Scroll screen and back screen that add shadows by sprites of the transparent shadow sprites can be selected on each screen.

The MSB shadow can not be used when using the sprite window. For more details about the sprite window, see "8.1 Window Area." The sprite shadow and transparent shadow are shown in Figure 14.4. Sprite data of the MSB shadow is shown in Figure 14.5.

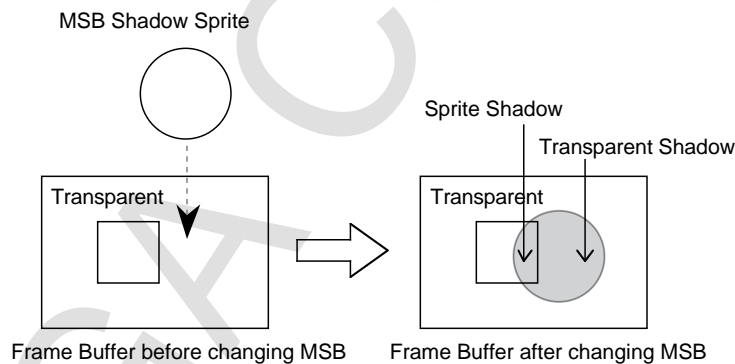

**Figure 14.4**      **Sprite shadow and transparent shadow**



### Sprite Shadow

Bit 15	14	13	12	11	10	9	8	7	6	5	4	3	2	1	0
1	X	X	X	X	X	X	X	X	X	X	X	X	X	X	X

The Xed bits could be either 0 or 1 as long as the dot color data in the selected sprite type does not meet the conditions of Normal Shadow.

### Transparent Shadow

Bit 15	14	13	12	11	10	9	8	7	6	5	4	3	2	1	0
1	0	0	0	0	0	0	0	0	0	0	0	0	0	0	0

**Figure 14.5 Sprite data of MSB shadow**

## Shadow Control Register

The shadow control register is a write-only 16-bit register that designates whether to use the shadow function for the scroll screen and back screen, and is located at address 1800E2H. Because the value is cleared to 0 after power on or reset, the value must be set.

	15	14	13	12	11	10	9	8
SDCTL	~	~	~	~	~	~	~	TPSDSL
1800E2H	7	6	5	4	3	2	1	0
	~	~	BKSDEN	R0SDEN	N3SDEN	N2SDEN	N1SDEN	N0SDEN

### Shadow enable bit (N0SDEN, N1SDEN, N2SDEN, N3SDEN, R0SDEN, BKSDEN)

This bit determines in sprites of the Normal shadow and transparent shadow whether to use the shadow function for the scroll screen and back screen.

N0SDEN	1800E2H	Bit 0	For NBG0 (or RBG1)
N1SDEN	1800E2H	Bit 1	For NBG1 (or EXBG)
N2SDEN	1800E2H	Bit 2	For NBG2
N3SDEN	1800E2H	Bit 3	For NBG3
R0SDEN	1800E2H	Bit 4	For RBG0
BKSDEN	1800E2H	Bit 5	For Back

The sprite of a sprite shadow always uses the shadow function for itself.

xxSDEN	Process
0	Does not use shadow function (shadow not added)
1	Uses shadow function (shadow added)

**Note:** N0, N1, N2, N3, R0, or BK is entered in bit name for xx.

**Transparent shadow select bit (TPSDSL), bit 8**

Determines whether to activate the sprite of the transparent shadow.

TPSDSL	Process
0	Disables transparent shadow sprite
1	Enables transparent shadow sprite

When the sprite of a transparent shadow is nullified, a shadow will no longer be projected on a screen by the transparent shadow sprite.



## Chapter 15 How to Use VDP2

15.1	Operation Flow .....	262
15.2	How to Use RAM .....	264
15.3	Bit Configuration Map .....	267

## 15.1 Operation Flow

Below is an overview of the steps for defining and setting VDP2 data.

**Step 1** Set the TV screen mode.

- Select normal graphics, high-resolution graphic, or exclusive monitor
- Set interlace mode
- Set vertical and horizontal resolution

**Step 2** Select the scroll screen to be used.

- Normal scroll screen (NMG0, NMG1, NMG2, NMG3)
- Rotation scroll screen (RNG0, RNG1)
- External input screen (EXBG)
- Line color screen (LNCL)
- Back screen (BACK)

**Step 3** Select the functions of each screen.

- Select cell format or bit map format

(A) Cell format

- Character color count
- Character size
- Pattern name data size
- Plane size
- Scaling function
- Line scroll function
- Vertical cell scroll function
- Mosaic process function

(B) Bit map format

- Bit map color count
- Bit map size
- Scaling function
- Rotation function
- Mosaic process function

**Step 4** Select the color RAM mode.

**Step 5** Select the window to be used.

When using the Normal window, store the line window table in VRAM.





**Step 6** Calculate the size of VRAM to determine whether the tables can be stored there.

- VRAM size
- Character pattern (number and size)
- Pattern name table (number and size)
- Bit map pattern (number and size)
- Line scroll table
- Vertical cell scroll table
- Rotation parameter table
- Coefficient table
- Line color screen table
- Back screen table
- Line window table

**Step 7** Select VRAM use.

- VRAM bank partition
- VRAM access method

**Step 8** Create character pattern and pattern name table.

- Select the character number supplement mode.
- Set reverse function bit.  
Creates a bit map pattern when in the bit map format.

**Step 9** Create other VRAM tables.

**Step 10** Define priority and color calculation in terms of sprite data.

**Step 11** Set special functions.

- Special function code
- Special priority function
- Extended color calculation function
- Gradation calculation function
- Color offset function
- Shadow function (Normal, MSB)

**Step 12** Reset the screen, redefine and reset VRAM and registers in terms of story.

## 15.2 How to Use RAM

When using VDP2, data is defined and set in VRAM, color RAM, and the register.

- **VRAM**

Data defined in VRAM differs depending on the scroll screen to be used, screen format, screen size, and the image process functions to be used. Data is defined in VRAM according to the register setting; defined addresses are set in the various address registers. Table 15.1 shows the main register connected with data defined in VRAM.



**Table 15.1 Register connected with data defined in VRAM**

Data	Definition	Register	Setting Data
Pattern name table	Character pattern lead address	Pattern Name Control Register (180030H~180038H)	Pattern Name Data Size, Character Number, Supplementary Mode, Pattern Name Supplementary Data
		Plane size register (18003AH)	Plane size when in displaying in cell format
		Normal scroll screen map register (180040H~18004EH)	Pattern Name Data lead address for each plane
		Rotation scroll screen map register (180050H~18006EH)	Pattern Name Data lead address for each plane
		Map offset register (18003CH~18003EH)	3 bits map offset value attached to map register upper bits
Character pattern	Dot data of cell	Character control register (180028H, 18002AH)	Character color count, character size
Bitmap pattern	Bitmap pattern data	Character control register (180028H, 18002AH)	Character color count (bitmap color count), bitmap size, bitmap enable
		Map offset register (18003CH~18003EH)	Boundary address of bitmap pattern
Line scroll table	Horizontal and vertical screen scroll value, horizontal coordinate increment	Line scroll table address register (1800A0H~1800A6H)	Line scroll table lead address
		Line & vertical cell scroll control register (18009AH)	Scroll configuration control data
Vertical cell scroll table	Vertical screen scroll value	Vertical cell scroll table address register (18009CH, 18009EH)	Vertical cell scroll table lead address
		Line & vertical cell scroll control register (18009AH)	Scroll configuration control data
Rotation parameter table	Rotation Parameter, Coefficient Table Related Registers	RAM control register (18000EH)	VRAM use per rotation scroll screen
		Rotation parameter table address register (1800BCH, 1800BEH)	Parameter table lead address
		Rotation parameter mode register (1800B0H)	Rotation parameter mode setting
Coefficient table	Coefficient table data (Zoom Coefficients $k_x$ , $k_y$ , and start point coordinate $X_p$ after rotation conversion)	RAM control register (18000EH)	VRAM use per rotation scroll screen
		Coefficient table control register (1800B4H)	Coefficient data mode, data size of coefficient data, coefficient table enable
		Coefficient table address offset register (1800B6H)	Coefficient table lead address offset value
Line color screen table	Color RAM address	Line color screen table address register (1800A8H, 1800AAH)	Line color screen color mode, line color screen table lead address
Back screen table	RGB color data	Back screen table address register (1800ACH, 1800AEH)	Back screen color mode, back screen table lead address
Line window table	Horizontal start point coordinate, horizontal end point coordinate	Line window table address register (1800D8H~1800DEH)	Line window enable, line window table lead address

- **Color RAM Definition**

Defines the sprite of the palette format and scroll screen color data. Color data stored in color RAM is in RGB format and has three modes. Mode selection designates in the color RAM mode (CRMD1, CRMD0, bits 13 and 12) of the RAM control register (18000EH).

The most significant bit of color data stored in color RAM is the enable bit when the special color calculation mode is mode 3. Color is calculated in dot units for dots using color data when the most significant bit color data is 1, the special color calculation mode is mode 3, the color format is the palette format, and the color calculation enable bit is 1.

- **Color RAM Reference**

Color RAM is referred from character patterns, bit map patterns, and line color screen table data. The color RAM address is expressed by 11 bits. When the character color count or bit map color count is 16-color, the 7-bit palette number added to the host becomes 11 bits; when 256-color, the 3-bit palette number added to the host becomes 11 bits. The palette number of the character pattern is in pattern name data and supplement data of the pattern name control register; the palette number of the bit map pattern is in the bit map palette number register.

- **Register**

The register is, as a rule, a write-only, 16-bit register that designates the VDP2 function. One function may extend in several registers, and several functions may be arrange in one register. Set registers corresponding to the functions to be used when needed.



## 15.3 Bit Configuration Map

Every register bit register is related to various other bits. The bit map configuration of separate scroll screens and separate priority functions is shown in the bit map configuration below.

### TV Screen Mode

- TV Screen Display (DISP, 180000H, bit 15)
  - └ 0 : Does not display picture on TV screen
  - └ 1 : Displays picture
- Boarder Color Mode (BDCLMD, 180000H, bit 8)
  - └ 0 : Displays Black
  - └ 1 : Displays Back Screen
- Interlace mode (LSMD, 180000H, bit 7~6)
  - └ 00 : Non-interlace
  - └ 10 : Single-density Interlace
  - └ 11 : Double-density Interlace
- Vertical Resolution (VRESO, 180000H, bit 5~4)
  - └ 00 : 224 Lines (NTSC format or PAL format TV)
  - └ 01 : 240 Lines (NTSC format or PAL format TV)
  - └ 10 : 256 Lines (PAL format TV)
- Horizontal Resolution (HRESO, 180000H, bit 2~0)
  - └ 000 : 320 Pixels (Normal Graphics A, NTSC format or PAL format TV)
  - └ 001 : 352 Pixels (Normal Graphics B, NTSC format or PAL format TV)
  - └ 010 : 640 Pixels (Hi-Res Graphics A, NTSC format or PAL format TV)
  - └ 011 : 704 Pixels (Hi-Res Graphics B, NTSC format or PAL format TV)
  - └ 100 : 320 Pixels (Exclusive Normal Graphics A, 31kHz monitor)
  - └ 101 : 352 Pixels (Exclusive Normal Graphics B, Hi-Vision monitor)
  - └ 110 : 640 Pixels (Exclusive Hi-Res Graphics A, 31kHz monitor)
  - └ 111 : 704 Pixels (Exclusive Hi-Res Graphics B, Hi-Vision monitor)

### External Signal Enable

- External Latch Enable (EXLTEN, 180002H, bit 9)
  - └ 0 : Latch when External Enable Register is read
  - └ 1 : Latches via external signal
- External Synchronization Enable (EXSYEN, 180002H, bit 8)
  - └ 0 : Does not input External Sync. Signal
  - └ 1 : Inputs External Sync. Signal and synchronizes TV screen display externally
- Image Display Area Select (DASEL, 180002H, bit 1)
  - └ 0 : Displays image in set display area only
  - └ 1 : Displays image in specified display area only
- External Screen Enable (EXBGEN, 180002H, bit 0)
  - └ 0 : Does not input External Screen Data
  - └ 1 : Inputs External Screen Data

## Screen Status

- External Latch Flag (EXLTFG, 180004H, bit 9)
  - └ 0 : Register is not latched (Register will be cleared when status is read)
  - └ 1 : HV Counter Value is latched in register
- External Synchronization Flag (EXSYFG, 180004H, bit 8)
  - └ 0 : Does not synchronize (Register will be cleared when status is read)
  - └ 1 : Internal Circuitry Synchronized
- V-Blank (VBLANK, 180004H, bit 3)
  - └ 0 : Scans during vertical display
  - └ 1 : Scans during vertical retrace (VBLANK)
- H-Blank (HBLANK, 180004H, bit 2)
  - └ 0 : Scans during horizontal display
  - └ 1 : Scans during horizontal retrace (HBLANK)
- Scan Field Flag (ODD, 180004H, bit 1)
  - └ 0 : Scans during even fields
  - └ 1 : Scans during odd fields
- TV Format Flag (PAL, 180004H, bit 0)
  - └ 0 : NTSC Format
  - └ 1 : PAL Format
- H-Counter Value (HCT, 180008H, bit 9~0)
- V-Counter Value (VCT, 18000AH, bit 9~0)



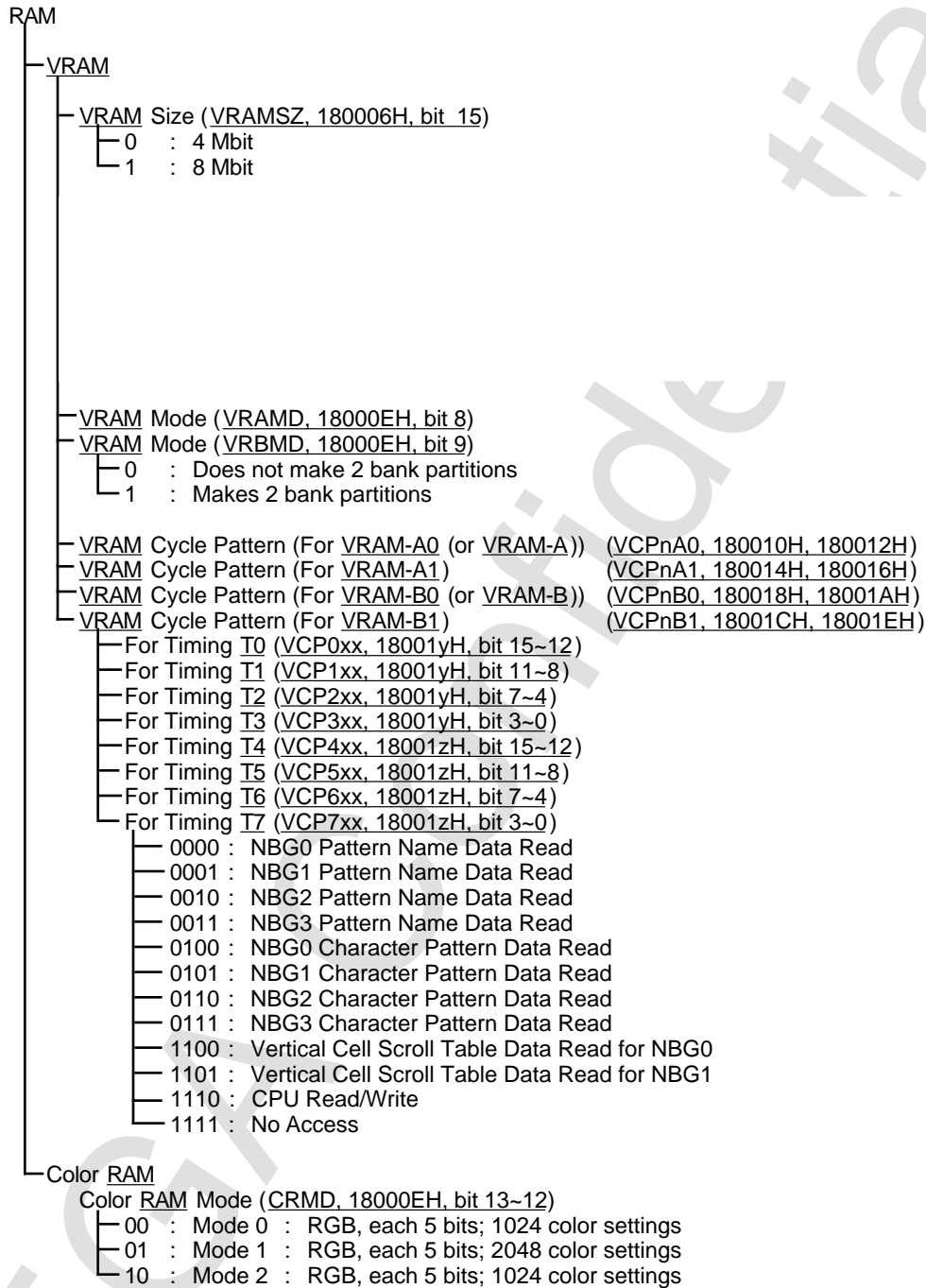

## Scroll Screen

- Normal Scroll Screen
  - NBG0
  - NBG1
  - NBG2
  - NBG3
- Rotation Scroll Screen
  - RBG0
  - RBG1
- External Input Screen : EXBG
- Line Screen
  - Line Color Screen : LNCL
  - Back Screen : BACK

## Normal Scroll Screen (NBG0)

- Transparent Display Enable (NOTPON, 180020H, bit 8)
  - 0 : Enables Transparent Code  
(Transparent coded dots become transparent)
  - 1 : Disables Transparent Code  
(Transparent coded dots are displayed according to their data value)
- Screen Display Enable (N00N, 180020H, bit 0)
  - 0 : Cannot Display (Does not access VRAM)
  - 1 : Can Display
- Character Color Count (N0CHCN, 180028H, bit 6~4)
  - 000 : 16 colors (Palette Format)
  - 001 : 256 colors (Palette Format)
  - 010 : 2048 colors (Palette Format)
  - 011 : 32,768 colors (RGB Format)
  - 100 : 16,770,000 colors (RGB Format)
- Bitmap Enable (N0BMEN, 180028H, bit 1)
  - 0 : Display in Cell Format → See Cell Format (NBG0)
  - 1 : Display in Bitmap Format → See Bitmap Format (NBG0)
- Mosaic Enable (N0MZE, 180022H, bit 0)
  - 0 : Does not execute Mosaic Process
  - 1 : Executes Mosaic Process
- Mosaic Size (MZSZx, 180022H)
  - Horizontal Mosaic Size (MZSZH, 180022H, bit 11~8)
  - Vertical Mosaic Size (MZSZV, 180022H, bit 15~12)

(Continued)





## Cell Format (NBG0)

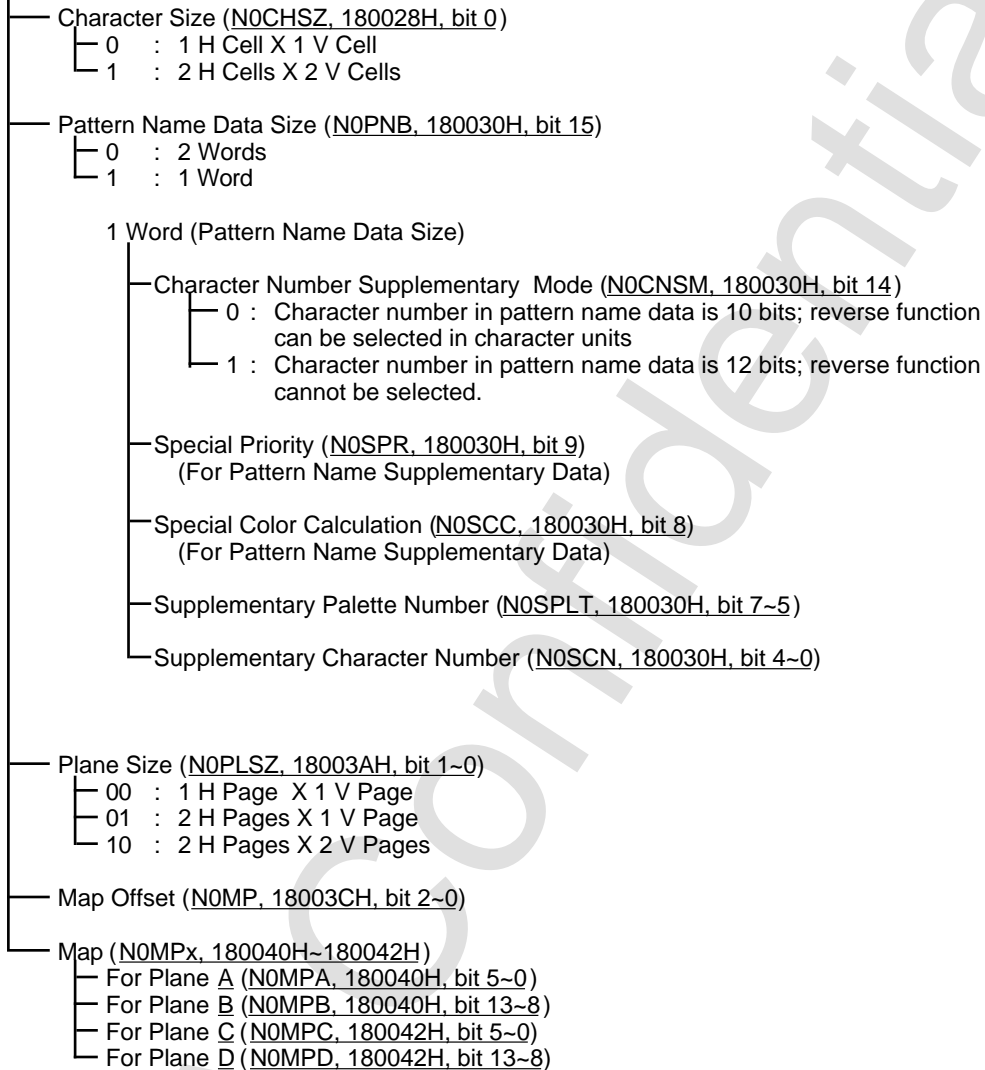

## Bitmap Format (NBG0)

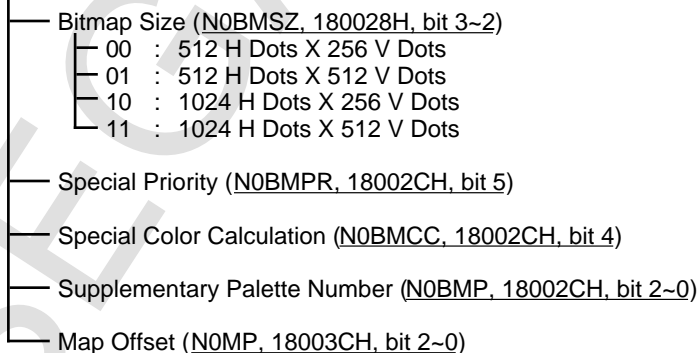

Normal Scroll Screen (NBG0) (continued)

- Screen Scroll Value (NOSCx, 180070H~180076H)
  - └ For Horizontal Direction (NOSCX, 180070H, bit 10~180072H, bit 8)
  - └ For Vertical Direction (NOSCY, 180074H, bit 10~180076H, bit 8)
- Coordinate Increment (NOZMx, 180078H~18007EH)
  - └ For Horizontal Direction (NOZMX, 180078H, bit 2~18007AH, bit 8)
  - └ For Vertical Direction (NOZMY, 18007CH, bit 2~18007EH, bit 8)
- Reduction Enable (NOZMQT, NOZMHF, 180098H, bit 1~0)
  - └ 00 : Reduction can not be displayed horizontally
  - └ 01 : Reduction can be displayed up to 1/2 horizontally
  - └ 10 : Reduction can be displayed up to 1/4 horizontally
  - └ 11 : Reduction can be displayed up to 1/4 horizontally
- Line Scroll Space (NOLSS, 18009AH, bit 5~4)
  - └ 00 : Every 1 Line (Non-interlace, Double-density Interlace),  
Every 2 Lines (Single-density Interlace)
  - └ 01 : Every 2 Lines (Non-interlace, Double-density Interlace),  
Every 4 Lines (Single-density Interlace)
  - └ 10 : Every 4 Line (Non-interlace, Double-density Interlace),  
Every 8 Lines (Single-density Interlace)
  - └ 11 : Every 8 Line (Non-interlace, Double-density Interlace),  
Every 16 Lines (Single-density Interlace)
- Line Zoom Enable (NOLZMX, 18009AH, bit 3)
  - └ 0 : Does not scale horizontally in line units
  - └ 1 : Scales horizontally in line units
- Line Scroll Enable (NOLSCY, 18009AH, bit 2)  
(For Vertical Screen Scroll Values)
  - └ 0 : Does not scroll vertically in line units
  - └ 1 : Scrolls vertically in line units
- Line Scroll Enable (NOLSCX, 18009AH, bit 1)  
(For Horizontal Screen Scroll Values)
  - └ 0 : Does not scroll horizontally in line units
  - └ 1 : Scrolls horizontally in line units
- Vertical Cell Scroll Enable (NOVCSC, 18009AH, bit 0)
  - └ 0 : No vertical cell scroll
  - └ 1 : Allows vertical cell scroll
- Line Scroll Table Address (NOLSTA, 1800A0H, bit 2~1800A2H, bit 1)
- Vertical Cell Scroll Table Address (VCSTA, 18009CH, bit 2~18009EH, bit 1)



Normal Scroll Screen (NBG1)

- Transparent Display Enable (N1TPON, 180020H, bit 9)
  - 0 : Turns on Transparent Code  
(Transparent coded dots become transparent)
  - 1 : Turns off Transparent Code  
(Transparent coded dots are displayed as per their data value)
- Screen Display Enable (N1ON, 180020H, bit 1)
  - 0 : Cannot Display (Cannot access VRAM during display)
  - 1 : Can Display
- Character Color Count (N1CHCN, 180028H, bit 13~12)
  - 00 : 16 colors (Palette Format)
  - 01 : 256 colors (Palette Format)
  - 10 : 2048 colors (Palette Format)
  - 11 : 32,768 colors (RGB Format)
- Bitmap Enable (N1BMEN, 180028H, bit 9)
  - 0 : Display in Cell Format → See Cell Format (NBG1)
  - 1 : Display in Bitmap Format → See Bitmap Format (NBG1)
- Mosaic Enable (N1MZE, 180022H, bit 1)
  - 0 : Does not execute Mosaic Process
  - 1 : Executes Mosaic Process
- Mosaic Size (MZSZx, 180022H)
  - Horizontal Mosaic Size (MZSZH, 180022H, bit 11~8)
  - Vertical Mosaic Size (MZSZV, 180022H, bit 15~12)

(Continued)

## Cell Format (NBG1)

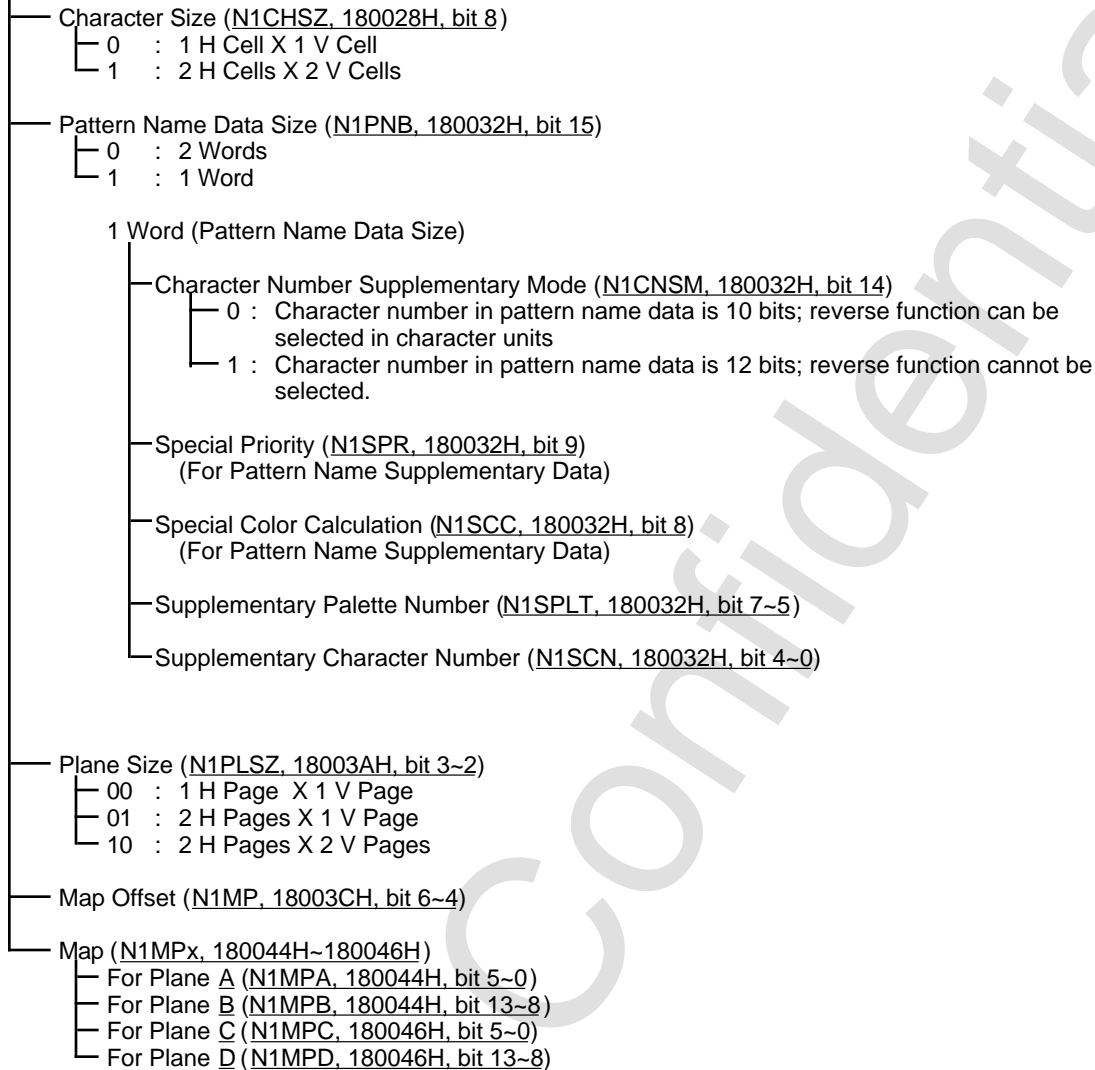

## Bitmap Format (NBG1)

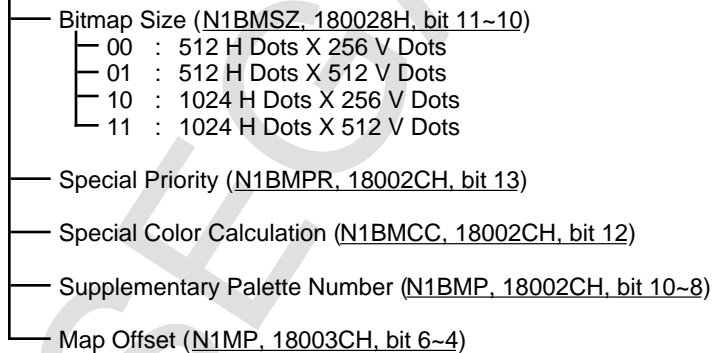

Normal Scroll Screen (NBG1) (Continued)

- Screen Scroll Value (N1SCx, 180080H~180086H)
  - └ For Horizontal Direction (N1SCX, 180080H, bit 10~180082H, bit 8)
  - └ For Vertical Direction (N1SCY, 180084H, bit 10~180086H, bit 8)
- Coordinate Increment (N1ZMx, 180088H~18008EH)
  - └ For Horizontal Direction (N1ZMX, 180088H, bit 2~18008AH, bit 8)
  - └ For Vertical Direction (N1ZMY, 18008CH, bit 2~18008EH, bit 8)
- Reduction Enable (N1ZMQT, N1ZMHF, 180098H, bit 9~8)
  - └ 00 : Reduction can not be displayed horizontally
  - └ 01 : Reduction can be displayed up to 1/2 horizontally
  - └ 10 : Reduction can be displayed up to 1/4 horizontally
  - └ 11 : Reduction can be displayed up to 1/4 horizontally
- Line Scroll Space (N1LSS, 18009AH, bit 13~12)
  - └ 00 : Every 1 Line (Non-interlace, Double-density Interlace),  
Every 2 Lines (Single-density Interlace)
  - └ 01 : Every 2 Lines (Non-interlace, Double-density Interlace),  
Every 4 Lines (Single-density Interlace)
  - └ 10 : Every 4 Line (Non-interlace, Double-density Interlace),  
Every 8 Lines (Single-density Interlace)
  - └ 11 : Every 8 Line (Non-interlace, Double-density Interlace),  
Every 16 Lines (Single-density Interlace)
- Line Zoom Enable (N1LZMX, 18009AH, bit 11)
  - └ 0 : No zoom horizontally in line units
  - └ 1 : Allows zoom horizontally in line units
- Line Scroll Enable (N1LSCY, 18009AH, bit 10)  
(For Vertical Screen Scroll Values)
  - └ 0 : No zoom vertically in line units
  - └ 1 : Allows zoom vertically in line units
- Line Scroll Enable (N1LSCX, 18009AH, bit 9)  
(For Horizontal Screen Scroll Values)
  - └ 0 : No scroll horizontally in line units
  - └ 1 : Allows scroll horizontally in line units
- Vertical Cell Scroll Enable (N1VCSC, 18009AH, bit 8)
  - └ 0 : No vertical cell scroll
  - └ 1 : Allows vertical cell scroll
- Line Scroll Table Address (N1LSTA, 1800A4H, bit 2~1800A6H, bit 1)
- Vertical Cell Scroll Table Address (VCSTA, 18009CH, bit 2~18009EH, bit 1)

Normal Scroll Screen (NBG2)

- Transparent Display Enable (N2TPON, 180020H, bit 10)
  - 0 : Turns on Transparent Code  
(Transparent coded dots become transparent)
  - 1 : Turns off Transparent Code  
(Transparent coded dots are displayed as per their data value)
- Screen Display Enable (N2ON, 180020H, bit 2)
  - 0 : Cannot Display (Cannot access VRAM during display)
  - 1 : Can Display
- Character Color Count (N2CHCN, 18002AH, bit 1)
  - 0 : 16 colors (Palette Format)
  - 1 : 256 colors (Palette Format)
- .....(Display in Cell Format) → See Cell Format (NBG2)
- Mosaic Enable (N2MZE, 180022H, bit 2)
  - 0 : Does not execute Mosaic Process
  - 1 : Executes Mosaic Process
- Mosaic Size (MZSZx, 180022H)
  - Horizontal Mosaic Size (MZSZH, 180022H, bit 11~8)
  - Vertical Mosaic Size (MZSZV, 180022H, bit 15~12)
- Screen Scroll Value (N2SCx, 180090H~180092H)
  - For Horizontal Direction (N2SCX, 180090H, bit 10~0)
  - For Vertical Direction (N2SCY, 180092H, bit 10~0)



Cell Format (NBG2)

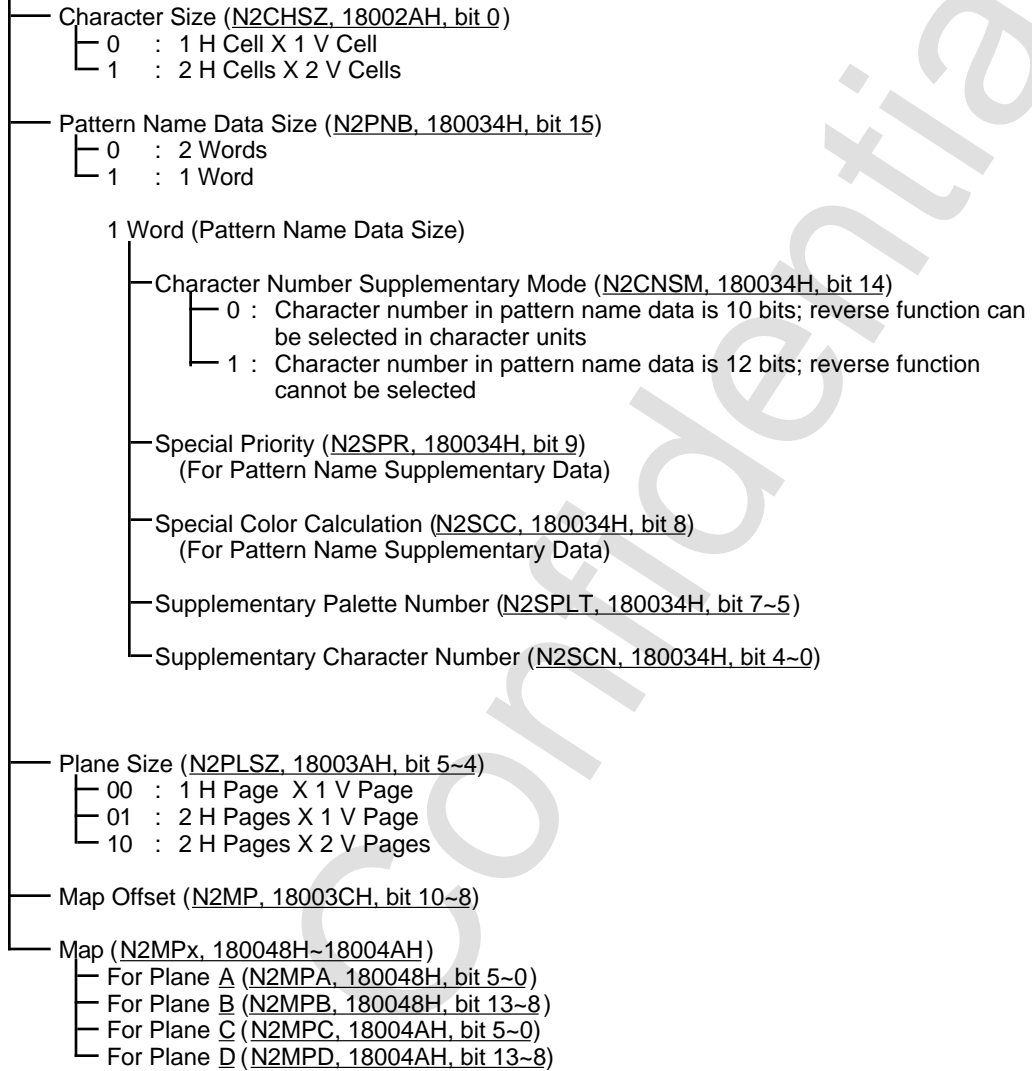

Normal Scroll Screen (NBG3)

- Transparent Display Enable (N3TPON, 180020H, bit 11)
  - └ 0 : Turns on Transparent Code  
(Transparent coded dots become transparent)
  - └ 1 : Turns off Transparent Code  
(Transparent coded dots are displayed as per their data value)
- Screen Display Enable (N3ON, 180020H, bit 3)
  - └ 0 : Cannot Display (Cannot access VRAM during display)
  - └ 1 : Can Display
- Character Color Count (N3CHCN, 18002AH, bit 5)
  - └ 0 : 16 colors (Palette Format)
  - └ 1 : 256 colors (Palette Format)
- ..... (Display in Cell Format) → See Cell Format (NBG3)
- Mosaic Enable (N3MZE, 180022H, bit 3)
  - └ 0 : Does not execute Mosaic Process
  - └ 1 : Executes Mosaic Process
- Mosaic Size (MZSZx, 180022H)
  - └ Horizontal Mosaic Size (MZSZH, 180022H, bit 11~8)
  - └ Vertical Mosaic Size (MZSZV, 180022H, bit 15~12)
- Screen Scroll Value (N3SCx, 180094H~180096H)
  - └ For Horizontal Direction (N3SCX, 180094H, bit 10~0)
  - └ For Vertical Direction (N3SCY, 180096H, bit 10~0)

SEGA Confidential





Cell Format (NBG3)

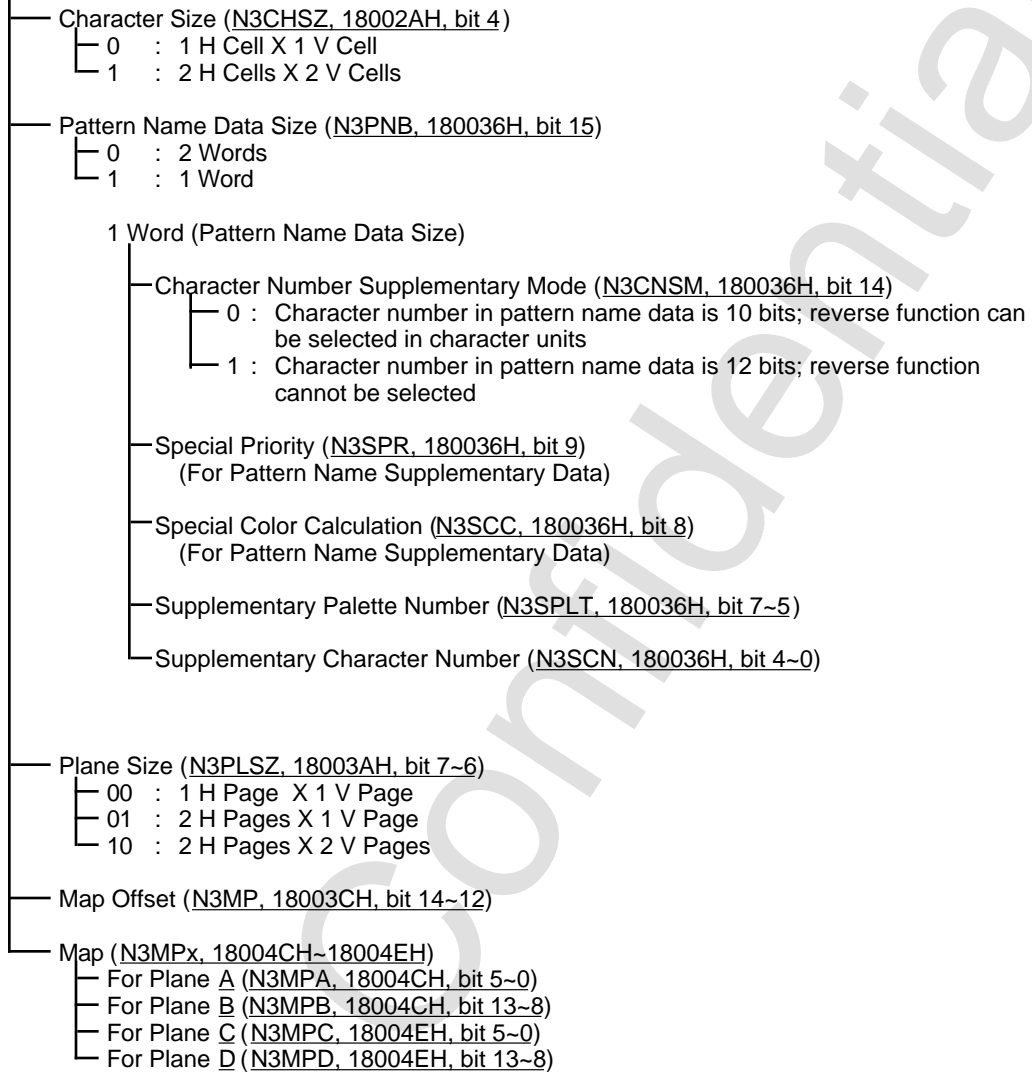

Rotation Scroll Screen (RBG0)

- Transparent Display Enable (R0TPON, 180020H, bit 12)
  - 0 : Turns on Transparent Code  
(Transparent coded dots become transparent)
  - 1 : Turns off Transparent Code  
(Transparent coded dots are displayed as per their data value)
- Screen Display Enable (R0ON, 180020H, bit 4)
  - 0 : Cannot Display (Cannot access VRAM during display)
  - 1 : Can Display
- Character Color Count (R0CHCN, 18002AH, bit 14~12)
  - 000 : 16 colors (Palette Format)
  - 001 : 256 colors (Palette Format)
  - 010 : 2048 colors (Palette Format)
  - 011 : 32,768 colors (RGB Format)
  - 100 : 16,770,000 colors (RGB Format)
- Bitmap Enable (R0BMEN, 18002AH, bit 9)
  - 0 : Display in Cell Format → See Cell Format (RBG0)
  - 1 : Display in Bitmap Format → See Bitmap Format (RBG0)
- Mosaic Enable (R0MZE, 180022H, bit 4)
  - 0 : Does not execute Mosaic Process
  - 1 : Executes Mosaic Process
- Mosaic Size (MZSZx, 180022H)
  - Horizontal Mosaic Size (MZSZH, 180022H, bit 11~8)
  - Vertical Mosaic Size (MZSZV, 180022H, bit 15~12)

(Continued)



Cell Format (RBG0)

Character Size (R0CHSZ, 18002AH, bit 8)

- 0 : 1 H Cell X 1 V Cell
- 1 : 2 H Cells X 2 V Cells

Pattern Name Data Size (R0PNB, 180038H, bit 15)

- 0 : 2 Words
- 1 : 1 Word

1 Word (Pattern Name Data Size)

Character Number Supplementary Mode (R0CNSM, 180038H, bit 14)

- 0 : Character number in pattern name data is 10 bits; reverse function can be selected in character units
- 1 : Character number in pattern name data is 12 bits; reverse function cannot be selected

Special Priority (R0SPR, 180038H, bit 9)  
(For Pattern Name Supplementary Data)

Special Color Calculation (R0SCC, 180038H, bit 8)  
(For Pattern Name Supplementary Data)

Supplementary Palette Number (R0SPLT, 180038H, bit 7~5)

Supplementary Character Number (R0SCN, 180038H, bit 4~0)

Rotation Parameter Mode (RPMD, 1800B0H, bit 1~0)

- 00 : Mode 0 : Use for Rotation Parameter A → See Rotation Parameter A (RBG0)
- 01 : Mode 1 : Use for Rotation Parameter B → See Rotation Parameter B (RBG0)

For Rotation Parameter A (RBG0)

- Plane Size (RAPLSZ, 18003AH, bit 9~8)
  - 00 : 1 H Page X 1 V Page
  - 01 : 2 H Pages X 1 V Page
  - 10 : 2 H Pages X 2 V Pages
- Screen Over Process (RAOVR, 18003AH, bit 11~10)
  - 00 : Outside the display area it repeats the image set in the display area
  - 01 : Outside the display area it repeats the image set in the Screen Over Pattern Register
  - 10 : Everything outside the display area is transparent
  - 11 : Sets display area to  $0 \leq x < 512$  and  $0 \leq y < 512$  regardless of the plane size or bitmap size. Everything outside the display area is transparent.
    - Screen Over Pattern Name (RAOPN, 1800B8H, bit 15~0)
- Map Offset (RAMP, 18003EH, bit 2~0)
- Map (RAMPx, 180050H~18005EH)
  - For Plane A (RAMPA, 180050H, bit 5~0)
  - For Plane B (RAMPB, 180050H, bit 13~8)
  - For Plane C (RAMPC, 180052H, bit 5~0)
  - For Plane D (RAMPD, 180052H, bit 13~8)
  - For Plane E (RAMPE, 180054H, bit 5~0)
  - For Plane F (RAMPF, 180054H, bit 13~8)
  - For Plane G (RAMPG, 180056H, bit 5~0)
  - For Plane H (RAMPH, 180056H, bit 13~8)
  - For Plane I (RAMPI, 180058H, bit 5~0)
  - For Plane J (RAMPJ, 180058H, bit 13~8)
  - For Plane K (RAMPK, 18005AH, bit 5~0)
  - For Plane L (RAMPL, 18005AH, bit 13~8)
  - For Plane M (RAMPM, 18005CH, bit 5~0)
  - For Plane N (RAMPN, 18005CH, bit 13~8)
  - For Plane O (RAMPO, 18005EH, bit 5~0)
  - For Plane P (RAMPP, 18005EH, bit 13~8)



## For Rotation Parameter B (RBG0)

- Plane Size (RBPLSZ, 18003AH, bit 13~12)
  - 00 : 1 H Page X 1 V Page
  - 01 : 2 H Pages X 1 V Page
  - 10 : 2 H Pages X 2 V Pages
- Screen Over Process (RBOVR, 18003AH, bit 15~14)
  - 00 : Outside the display area it repeats the image set in the display area
  - 01 : Outside the display area it repeats the image set in the Screen Over Pattern Register
  - 10 : Everything outside the display area is transparent
  - 11 : Sets display area to  $0 \leq x < 512$  and  $0 \leq y < 512$  regardless of the plane size or bitmap size. Everything outside the display area is transparent.
    - Screen Over Pattern Name (RBOPN, 1800BAH, bit 15~0)
- Map Offset (RBMP, 18003EH, bit 6~4)
- Map (RBMPx, 180060H~18006EH)
  - For Plane A (RBMPA, 180060H, bit 5~0)
  - For Plane B (RBMPB, 180060H, bit 13~8)
  - For Plane C (RBMP\_C, 180062H, bit 5~0)
  - For Plane D (RBMPD, 180062H, bit 13~8)
  - For Plane E (RBMP\_E, 180064H, bit 5~0)
  - For Plane F (RBMPF, 180064H, bit 13~8)
  - For Plane G (RBMPG, 180066H, bit 5~0)
  - For Plane H (RBMPH, 180066H, bit 13~8)
  - For Plane I (RBMPI, 180068H, bit 5~0)
  - For Plane J (RBMPJ, 180068H, bit 13~8)
  - For Plane K (RBMPK, 18006AH, bit 5~0)
  - For Plane L (RBMP\_L, 18006AH, bit 13~8)
  - For Plane M (RBMPM, 18006CH, bit 5~0)
  - For Plane N (RBMPN, 18006CH, bit 13~8)
  - For Plane O (RBMP\_O, 18006EH, bit 5~0)
  - For Plane P (RBMP\_P, 18006EH, bit 13~8)

## Bitmap Format (RBG0)

- Bitmap Size (ROBMSZ, 18002AH, bit 10)
  - 0 : 512 H Dots X 256 V Dots
  - 1 : 512 H Dots X 512 V Dots
- Special Priority (ROBMPR, 18002EH, bit 5)
- Special Color Calculation (ROBMCC, 18002EH, bit 4)
- Supplementary Palette Number (ROBMP, 18002EH, bit 2~0)
- Rotation Parameter Mode (RPMD, 1800B0H, bit 1~0)
  - 00 : Mode 0 : Use for Rotation Parameter A
  - 01 : Mode 1 : Use for Rotation Parameter B
    - Map Offset (For Rotation Parameter A) (RAMP, 18003EH, bit 2~0)
    - Map Offset (For Rotation Parameter B) (RBMP, 18003EH, bit 6~4)

Rotation Scroll Screen (RBG0) (Continued)

- Rotation Data Bank Setting (RDBSxx, 18000EH)
  - For VRAM-A0 (or VRAM-A) (RDBSA0, 18000EH, bit 1~0)
  - For VRAM-A1 (RDBSA1, 18000EH, bit 3~2)
  - For VRAM-B0 (or VRAM-B) (RDBSB0, 18000EH, bit 5~4)
  - For VRAM-B1 (RDBSB1, 18000EH, bit 7~6)
    - 00 : Not used as RAM for RBG0
    - 01 : RAM for RBG0 Coefficient Data Table
    - 10 : RAM for RBG0 Pattern Name Table
    - 11 : RAM for RBG0 Character Pattern Table (or Bitmap Pattern)
- Parameter Read Enable (RxxxSTRE, 1800B2H)
  - For Rotation Parameter A Xst (RAXSTRE, 1800B2H, bit 0)
  - For Rotation Parameter B Xst (RBXSTRE, 1800B2H, bit 8)
  - For Rotation Parameter A Yst (RAYSTRE, 1800B2H, bit 1)
  - For Rotation Parameter B Yst (RBYSTRE, 1800B2H, bit 9)
  - For Rotation Parameter A KAst (RAKASTRE, 1800B2H, bit 2)
  - For Rotation Parameter B KAst (RBKASTRE, 1800B2H, bit 10)
    - 0 : Selected parameter is not read per line
    - 1 : Selected parameter is read per line
- Rotation Parameter Table Address (RPTA, 1800BCH, bit 2~1800BEH, bit 1)
- Rotation Parameter Mode (RPMD, 1800B0H, bit 1~0)
  - 00 : Mode 0 : Rotation Parameter A
  - 01 : Mode 1 : Rotation Parameter B
  - 10 : Mode 2 : A image and B image are switched according to coefficient data read from rotation parameter A coefficient table
  - 11 : Mode 3 : A image and B image are switched according to rotation parameter window
- Coefficient Line Color Enable (RxKLCE, 1800B4H)
  - For Rotation Parameter A (RAKLCE, 1800B4H, bit 4)
  - For Rotation Parameter B (RBKLCE, 1800B4H, bit 12)
    - 0 : Line color screen data in coefficient data is not used
    - 1 : Line color screen data in coefficient data is used
- Coefficient Data Mode (RxKMD, 1800B4H)
  - For Rotation Parameter A (RAKMD, 1800B4H, bit 3~2)
  - For Rotation Parameter B (RBKMD, 1800B4H, bit 11~10)
    - 00 : Mode 0 : Used as zoom coefficients kx and ky
    - 01 : Mode 1 : Used as zoom coefficient kx
    - 10 : Mode 2 : Used as zoom coefficient ky
    - 11 : Mode 3 : Used as viewpoint coordinate Xp after conversion
- Coefficient Data Size (RxKDBS, 1800B4H)
  - For Rotation Parameter A (RAKDBS, 1800B4H, bit 1)
  - For Rotation Parameter B (RBKDBS, 1800B4H, bit 9)
    - 0 : 2 Words
    - 1 : 1 Word
- Coefficient Table Enable (RxKTE, 1800B4H)
  - For Rotation Parameter A (RAKTE, 1800B4H, bit 0)
  - For Rotation Parameter B (RBKTE, 1800B4H, bit 8)
    - 0 : Does not use Coefficient Table
    - 1 : Uses Coefficient Table
- Coefficient Table Address Offset (RxKTAOS, 1800B6H)
  - For Rotation Parameter A (RAKTAOS, 1800B6H, bit 2~0)
  - For Rotation Parameter B (RBKTAOS, 1800B6H, bit 10~8)



Rotation Scroll Screen (RBG1)

Transparent Display Enable (For NBG0) (N0TPON, 180020H, bit 8)

- └ 0 : Turns on Transparent Code  
(Transparent coded dots become transparent)
- └ 1 : Turns off Transparent Code  
(Transparent coded dots are displayed as per their data value)

Screen Display Enable (R1ON, 180020H, bit 5)

- └ 0 : Cannot Display (Cannot access VRAM during display)
- └ 1 : Can Display

Character Color Count (For NBG0) (N0CHCN, 180028H, bit 6~4)

- └ 000 : 16 colors (Palette Format)
- └ 001 : 256 colors (Palette Format)
- └ 010 : 2048 colors (Palette Format)
- └ 011 : 32786 colors (RGB Format)
- └ 100 : 16,770,000 colors (RBG Format)

..... (Display in Cell Format)

→ See Cell Format (RBG1)

Mosaic Enable (For NBG0) (N0MZE, 180022H, bit 0)

- └ 0 : Does not execute Mosaic Process
- └ 1 : Executes Mosaic Process

Mosaic Size (MZSZx, 180022H)

- └ Horizontal Mosaic Size (MZSZH, 180022H, bit 11~8)
- └ Vertical Mosaic Size (MZSZV, 180022H, bit 15~12)

Cell Format (RBG1)

- Character Size (For NBG0) (NOCHSZ, 180028H, bit 0)
  - 0 : 1 H Cell X 1 V Cell
  - 1 : 2 H Cells X 2 V Cells
- Pattern Name Data Size (For NBG0) (N0PNB, 180030H, bit 15)
  - 0 : 2 Words
  - 1 : 1 Word
- 1 Word (Pattern Name Data Size)
  - Character Number Supplementary Mode (For NBG0) (NOCNSM, 180030H, bit 14)
    - 0 : Character number in pattern name data is 10 bits, reverse function can be selected per character unit
    - 1 : Character number in pattern name data is 12 bits, reverse function cannot be selected
  - Special Priority (For NBG0) (N0SPR, 180030H, bit 9)  
(For Pattern Name Supplementary Data)
  - Special Color Calculation (For NBG0) (N0SCC, 180030H, bit 8)  
(For Pattern Name Supplementary Data)
  - Supplementary Palette Number (For NBG0) (N0SPLT, 180030H, bit 7~5)
  - Supplementary Character Number (For NBG0) (N0SCN, 180030H, bit 4~0)

..... (For use of Rotation Parameter B) → See Rotation Parameter B (RBG1)

For Rotation Parameter B (RBG1)

- Plane Size (RBPLSZ, 18003AH, bit 13~12)
  - 00 : 1 H Page X 1 V Page
  - 01 : 2 H Pages X 1 V Page
  - 10 : 2 H Pages X 2 V Pages
- Screen Over Process (RBOVR, 18003AH, bit 15~14)
  - 00 : Outside the display area it repeats the image set in the display area
  - 01 : Outside the display area it repeats the image set in the Screen Over Pattern Register
  - 10 : Everything outside the display area is transparent
  - 11 : Sets display area to  $0 \leq x < 512$  and  $0 \leq y < 512$  regardless of the plane size or bitmap size.  
 Screen Over Pattern Name (RBOPN, 1800BAH, bit 15~0)
- Map Offset (RBMP, 18003EH, bit 6~4)
- Map (RBMPx, 180060H~18006EH)
  - For Plane A (RBMPA, 180060H, bit 5~0)
  - For Plane B (RBMPB, 180060H, bit 13~8)
  - For Plane C (RBMPC, 180062H, bit 5~0)
  - For Plane D (RBMPD, 180062H, bit 13~8)
  - For Plane E (RBMP E, 180064H, bit 5~0)
  - For Plane F (RBMPF, 180064H, bit 13~8)
  - For Plane G (RBMPG, 180066H, bit 5~0)
  - For Plane H (RBMPH, 180066H, bit 13~8)
  - For Plane I (RBMPI, 180068H, bit 5~0)
  - For Plane J (RBMPJ, 180068H, bit 13~8)
  - For Plane K (RBMPK, 18006AH, bit 5~0)
  - For Plane L (RBMP L, 18006AH, bit 13~8)
  - For Plane M (RBMPM, 18006CH, bit 5~0)
  - For Plane N (RBMPN, 18006CH, bit 13~8)
  - For Plane O (RBMP O, 18006EH, bit 5~0)
  - For Plane P (RBMP P, 18006EH, bit 13~8)





### Line Color Screen (LNCL)

- Line Color Screen Color Mode (LCCLMD, 1800A8H, bit 15)
  - 0 : Single Color
  - 1 : Select per line
- Line Color Screen Table Address (LCTA, 1800A8H, bit 2~1800AAH, bit 0)

### Back Screen (BACK)

- Back Screen Color Mode (BKCLMD, 1800ACH, bit 15)
  - 0 : Single Color
  - 1 : Set each line
- Back Screen Table Address (BKTA, 1800ACH, bit 2~1800AEH, bit 0)

### Window

- Normal Rectangular Window
  - W0
  - W1
- Normal Line Window
- Sprite Window : SW

### Normal Rectangular Window

- Window Position (For Horizontal Coordinate) (WxxX, 1800C0H~1800CCH)
  - W0 Start Point Coordinate (W0SX, 1800C0H, bit 9~0)
  - W0 End Point Coordinate (W0EX, 1800C4H, bit 9~0)
  - W1 Start Point Coordinate (W1SX, 1800C8H, bit 9~0)
  - W1 End Point Coordinate (W1EX, 1800CCH, bit 9~0)
- Window Position (For Vertical Coordinate) (WxxY, 1800C2H~1800CEH)
  - W0 Start Point Coordinate (W0SY, 1800C2H, bit 8~0)
  - W0 End Point Coordinate (W0EY, 1800C6H, bit 8~0)
  - W1 Start Point Coordinate (W1SY, 1800CAH, bit 8~0)
  - W1 End Point Coordinate (W1EY, 1800CEH, bit 8~0)

### Normal Line Window

- Line Window Enable (WxLWE, 1800D8H~1800DCH)
  - For W0 (W0LWE, 1800D8H, bit 15)
  - For W1 (W1LWE, 1800DCH, bit 15)
    - 0 : Does not set normal window to line window
    - 1 : Sets normal window to line window
- Line Window Table Address (WxLWTA, 1800D8H~1800DEH)
  - For W0 (W0LWTA, 1800D8H, bit 2~1800DAH, bit 1)
  - For W1 (W1LWTA, 1800DCH, bit 2~1800DEH, bit 1)

### Sprite Window

- Sprite Window Enable (SPWINEN, 1800E0H, bit 4)
  - 0 : Does not use Sprite Window
  - 1 : Uses Sprite Window

## Window Control

Window Logic ( <u>xxLOG</u> , 1800D0H~1800D6H)		
—	For <u>NBG0</u> of Transparent Process Window (or <u>RBG1</u> )	( <u>N0LOG</u> , 1800D0H, bit 7)
—	For <u>NBG1</u> of Transparent Process Window (or <u>EXBG</u> )	( <u>N1LOG</u> , 1800D0H, bit 15)
—	For <u>NBG2</u> of Transparent Process Window	( <u>N2LOG</u> , 1800D2H, bit 7)
—	For <u>NBG3</u> of Transparent Process Window	( <u>N3LOG</u> , 1800D2H, bit 15)
—	For <u>RBG0</u> of Transparent Process Window	( <u>R0LOG</u> , 1800D4H, bit 7)
—	For Sprite of Transparent Process Window	( <u>SPL0G</u> , 1800D4H, bit 15)
—	For Rotation Parameter Window	( <u>RPLOG</u> , 1800D6H, bit 7)
—	For Color Calculation Window	( <u>CCL0G</u> , 1800D6H, bit 15)
	└ 0 : OR	
	└ 1 : AND	
Window Enable (For <u>W0</u> ) ( <u>xxW0E</u> , 1800D0H~1800D6H)		
—	For <u>NBG0</u> of Transparent Process Window (or <u>RBG1</u> )	( <u>N0W0E</u> , 1800D0H, bit 7)
—	For <u>NBG1</u> of Transparent Process Window (or <u>EXBG</u> )	( <u>N1W0E</u> , 1800D0H, bit 9)
—	For <u>NBG2</u> of Transparent Process Window	( <u>N2W0E</u> , 1800D2H, bit 7)
—	For <u>NBG3</u> of Transparent Process Window	( <u>N3W0E</u> , 1800D2H, bit 9)
—	For <u>RBG0</u> of Transparent Process Window	( <u>R0W0E</u> , 1800D4H, bit 7)
—	For Sprite of Transparent Process Window	( <u>SPW0E</u> , 1800D4H, bit 9)
—	For Rotation Parameter Window	( <u>RPW0E</u> , 1800D6H, bit 7)
—	For Color Calculation Window	( <u>CCW0E</u> , 1800D6H, bit 9)
	└ 0 : Does not use W0 Window	
	└ 1 : Uses W0 Window	
Window Enable (For <u>W1</u> ) ( <u>xxW1E</u> , 1800D0H~1800D6H)		
—	For <u>NBG0</u> of Transparent Process Window (or <u>RBG1</u> )	( <u>N0W1E</u> , 1800D0H, bit 3)
—	For <u>NBG1</u> of Transparent Process Window (or <u>EXBG</u> )	( <u>N1W1E</u> , 1800D0H, bit 11)
—	For <u>NBG2</u> of Transparent Process Window	( <u>N2W1E</u> , 1800D2H, bit 3)
—	For <u>NBG3</u> of Transparent Process Window	( <u>N3W1E</u> , 1800D2H, bit 11)
—	For <u>RBG0</u> of Transparent Process Window	( <u>R0W1E</u> , 1800D4H, bit 3)
—	For Sprite of Transparent Process Window	( <u>SPW1E</u> , 1800D4H, bit 11)
—	For Rotation Parameter Window	( <u>RPW1E</u> , 1800D6H, bit 3)
—	For Color Calculation Window	( <u>CCW1E</u> , 1800D6H, bit 11)
	└ 0 : Does not use W1 Window	
	└ 1 : Uses W1 Window	
Window Enable (For <u>SW</u> ) ( <u>xxSWE</u> , 1800D0H~1800D6H)		
—	For <u>NBG0</u> of Transparent Process Window (or <u>RBG1</u> )	( <u>N0SWE</u> , 1800D0H, bit 5)
—	For <u>NBG1</u> of Transparent Process Window (or <u>EXBG</u> )	( <u>N1SWE</u> , 1800D0H, bit 13)
—	For <u>NBG2</u> of Transparent Process Window	( <u>N2SWE</u> , 1800D2H, bit 5)
—	For <u>NBG3</u> of Transparent Process Window	( <u>N3SWE</u> , 1800D2H, bit 13)
—	For <u>RBG0</u> of Transparent Process Window	( <u>R0SWE</u> , 1800D4H, bit 5)
—	For Sprite of Transparent Process Window	( <u>SPSWE</u> , 1800D4H, bit 13)
—	For Color Calculation Window	( <u>CCSWE</u> , 1800D6H, bit 13)
	└ 0 : Does not use SW Window	
	└ 1 : Uses SW Window	

(Continued)



Window Control (Continued)

Window Area (For W0) (xxW0A, 1800D0H~1800D6H)		
— For <u>NBG0</u> of Transparent Process Window (or <u>RBG1</u> )		(N0W0A, 1800D0H, bit 0)
— For <u>NBG1</u> of Transparent Process Window (or <u>EXBG</u> )		(N1W0A, 1800D0H, bit 8)
— For <u>NBG2</u> of Transparent Process Window		(N2W0A, 1800D2H, bit 0)
— For <u>NBG3</u> of Transparent Process Window		(N3W0A, 1800D2H, bit 8)
— For <u>RBG0</u> of Transparent Process Window		(R0W0A, 1800D4H, bit 0)
— For Sprite of Transparent Process Window		(SPW0A, 1800D4H, bit 8)
— For Rotation Parameter Window		(RPW0A, 1800D6H, bit 0)
— For Color Calculation Window		(CCW0A, 1800D6H, bit 8)
— 0 : Activates Inside of W0 Window		
— 1 : Activates Outside of W0 Window		
Window Area (For W1) (xxW1A, 1800D0H~1800D6H)		
— For <u>NBG0</u> of Transparent Process Window (or <u>RBG1</u> )		(N0W1A, 1800D0H, bit 2)
— For <u>NBG1</u> of Transparent Process Window (or <u>EXBG</u> )		(N1W1A, 1800D0H, bit 10)
— For <u>NBG2</u> of Transparent Process Window		(N2W1A, 1800D2H, bit 2)
— For <u>NBG3</u> of Transparent Process Window		(N3W1A, 1800D2H, bit 10)
— For <u>RBG0</u> of Transparent Process Window		(R0W1A, 1800D4H, bit 2)
— For Sprite of Transparent Process Window		(SPW1A, 1800D4H, bit 10)
— For Rotation Parameter Window		(RPW1A, 1800D6H, bit 2)
— For Color Calculation Window		(CCW1A, 1800D6H, bit 10)
— 0 : Activates Inside of W1 Window		
— 1 : Activates Outside of W1 Window		
Window Area (For SW) (xxSWA, 1800D0H~1800D6H)		
— For <u>NBG0</u> of Transparent Process Window (or <u>RBG1</u> )		(N0SWA, 1800D0H, bit 4)
— For <u>NBG1</u> of Transparent Process Window (or <u>EXBG</u> )		(N1SWA, 1800D0H, bit 12)
— For <u>NBG2</u> of Transparent Process Window		(N2SWA, 1800D2H, bit 4)
— For <u>NBG3</u> of Transparent Process Window		(N3SWA, 1800D2H, bit 12)
— For <u>RBG0</u> of Transparent Process Window		(R0SWA, 1800D4H, bit 4)
— For Sprite of Transparent Process Window		(SPSWA, 1800D4H, bit 12)
— For Color Calculation Window		(CCSWA, 1800D6H, bit 12)
— 0 : Activates Inside of SW Window		
— 1 : Activates Outside of SW Window		

## Sprite

- Sprite Color Calculation Condition (SPCCCS, 1800E0H, bit 13~12)
  - 00 : When (Priority Number)  $\leq$  (Color Calculation Condition Number)
  - 01 : When (Priority Number) = (Color Calculation Condition Number)
  - 10 : When (Priority Number)  $\geq$  (Color Calculation Condition Number)
  - 11 : When the MSB of the Color Data is 1
- Sprite Color Calculation Condition Number (SPCCN, 1800E0H, BIT 10~8)
- Sprite Color Mode (SPCLMD, 1800E0H, bit 5)
  - 0 : All sprite data is palette format only
  - 1 : Sprite data is a combination of palette format and RGB format
- Sprite Window Enable (SPWINEN, 1800E0H, bit 4)
  - 0 : Does not use Sprite Window
  - 1 : Uses Sprite Window
- Sprite Type (SPTYPE, 1800E0H, bit 3~0)
- Priority Number (For Sprite) (SxPRIN, 1800F0H~1800F6H)
  - For Sprite Register 0 (S0PRIN, 1800F0H, bit 2~0)
  - For Sprite Register 1 (S1PRIN, 1800F0H, bit 10~8)
  - For Sprite Register 2 (S2PRIN, 1800F2H, bit 2~0)
  - For Sprite Register 3 (S3PRIN, 1800F2H, bit 10~8)
  - For Sprite Register 4 (S4PRIN, 1800F4H, bit 2~0)
  - For Sprite Register 5 (S5PRIN, 1800F4H, bit 10~8)
  - For Sprite Register 6 (S6PRIN, 1800F6H, bit 2~0)
  - For Sprite Register 7 (S7PRIN, 1800F6H, bit 10~8)
- Color Calculation Ratio (For Sprite) (SxCCRT, 180100H~180106H)
  - For Sprite Register 0 (S0CCRT, 180100H, bit 4~0)
  - For Sprite Register 1 (S1CCRT, 180100H, bit 12~8)
  - For Sprite Register 2 (S2CCRT, 180102H, bit 4~0)
  - For Sprite Register 3 (S3CCRT, 180102H, bit 12~8)
  - For Sprite Register 4 (S4CCRT, 180104H, bit 4~0)
  - For Sprite Register 5 (S5CCRT, 180104H, bit 12~8)
  - For Sprite Register 6 (S6CCRT, 180106H, bit 4~0)
  - For Sprite Register 7 (S7CCRT, 180106H, bit 12~8)



Dot Color Data

- Color RAM Address Offset (xxCAOS, 1800E4H~1800E6H)
  - For NBG0 (or RBG1) (N0 CAOS, 1800E4H, bit 2~0)
  - For NBG1 (or EXBG) (N1 CAOS, 1800E4H, bit 6~4)
  - For NBG2 (N2 CAOS, 1800E4H, bit 10~8)
  - For NBG3 (N3 CAOS, 1800E4H, bit 14~12)
  - For RBG0 (R0 CAOS, 1800E6H, bit 2~0)
  - For Sprite (SPCAOS, 1800E6H, bit 4~0)
  
- Special Function Code Select (xxSFC S, 180024H)
  - For NBG0 (or RBG1) (N0 SFC S, 180024H, bit 0)
  - For NBG1 (or EXBG) (N1 SFC S, 180024H, bit 1)
  - For NBG2 (N2 SFC S, 180024H, bit 2)
  - For NBG3 (N3 SFC S, 180024H, bit 3)
  - For RBG0 (R0 SFC S, 180024H, bit 4)
    - 0 : Activates Special Function Code A
    - 1 : Activates Special Function Code B
  
- Special Function Code (SF CDxx, 180026H)
  - For Special Function Code A (SFC DAx, 180026H, bit 7~0)
  - For Special Function Code B (SFC DBx, 180026H, bit 15~8)
    - SF CDx0 : When Dot Color Code's lower 4 bits are 0H or 1H
    - SF CDx1 : When Dot Color Code's lower 4 bits are 2H or 3H
    - SF CDx2 : When Dot Color Code's lower 4 bits are 4H or 5H
    - SF CDx3 : When Dot Color Code's lower 4 bits are 6H or 7H
    - SF CDx4 : When Dot Color Code's lower 4 bits are 8H or 9H
    - SF CDx5 : When Dot Color Code's lower 4 bits are AH or BH
    - SF CDx6 : When Dot Color Code's lower 4 bits are CH or DH
    - SF CDx7 : When Dot Color Code's lower 4 bits are EH or FH
    - 0 : Does not use Special Function
    - 1 : Uses Special Function

Priority

- Line Color Screen Insert Enable (xxLCEN, 1800E8H)
  - For NBG0 (or RBG1) (N0LCEN, 1800E8H, bit 0)
  - For NBG1 (or EXBG) (N1LCEN, 1800E8H, bit 1)
  - For NBG2 (N2LCEN, 1800E8H, bit 2)
  - For NBG3 (N3LCEN, 1800E8H, bit 3)
  - For RBG0 (R0LCEN, 1800E8H, bit 4)
  - For Sprite (SPLCEN, 1800E8H, bit 5)
    - 0 : Does not insert line color screen when the corresponding screen is the top image
    - 1 : Inserts line color screen when the corresponding screen is the top image
  
- Special Priority Mode (xxSPRM, 1800EAH)
  - For NBG0 (or RBG1) (N0SPRM, 1800EAH, bit 1~0)
  - For NBG1 (or EXBG) (N1SPRM, 1800EAH, bit 3~2)
  - For NBG2 (N2SPRM, 1800EAH, bit 5~4)
  - For NBG3 (N3SPRM, 1800EAH, bit 7~6)
  - For RBG0 (R0SPRM, 1800EAH, bit 9~8)
    - 00 : Mode 0 : Selects number LSB per screen
    - 01 : Mode 1 : Selects number LSB per character
    - 10 : Mode 2 : Selects number LSB per dot
  
- Special Priority Number (For Scroll Screen) (xxPRIN, 1800F8H~1800FCH)
  - For NBG0 (or RBG1) (N0PRIN, 1800F8H, bit 2~0)
  - For NBG1 (or EXBG) (N1PRIN, 1800F8H, bit 10~8)
  - For NBG2 (N2PRIN, 1800FAH, bit 2~0)
  - For NBG3 (N3PRIN, 1800FAH, bit 10~8)
  - For RBG0 (R0PRIN, 1800FCH, bit 2~0)



## Color Calculation

### Gradation Calculation Enable (BOKEN, 1800ECH, bit 15)

- └ 0 : Does not use Gradation Calculation Function
- └ 1 : Uses Gradation Calculation Function

### Gradation Screen Number (BOKN, 1800ECH, bit 14~12)

- └ 000 : Sprite
- └ 001 : RBG0
- └ 010 : NBG0 or RBG1
- └ 100 : NBG1 or EXBG
- └ 101 : NBG2
- └ 110 : NBG3

### Expanded Color Calculation Enable (EXCCEN, 1800ECH, bit 10)

- └ 0 : Does not use Expanded Color Calculation
- └ 1 : Uses Expanded Color Calculation

### Color Calculation Ratio Mode (CCRTMD, 1800ECH, bit 9)

- └ 0 : Mode 0 : In the case of color calculation, select per top image side
- └ 1 : Mode 1 : In the case of color calculation, select per second image side

### Color Calculation Mode (CCMD, 1800ECH, bit 8)

- └ 0 : Mode 0 : Add according to the register value color calculation ratio
- └ 1 : Mode 1 : Add as is

### Color Calculation Enable (xxCCEN, 1800ECH)

- └ For NBG0 (or RBG1) (N0CCEN, 1800ECH, bit 0)
- └ For NBG1 (or EXBG) (N1CCEN, 1800ECH, bit 1)
- └ For NBG2 (N2CCEN, 1800ECH, bit 2)
- └ For NBG3 (N3CCEN, 1800ECH, bit 3)
- └ For RBG0 (R0CCEN, 1800ECH, bit 4)
- └ For LNCL (LCCEN, 1800ECH, bit 5)
- └ For Sprite (SPCCEN, 1800ECH, bit 6)
  - └ 0 : Does not do Color Calculation
  - └ 1 : Does Color Calculation

### Special Color Calculation Mode (xxSCCM, 1800EEH)

- └ For NBG0 (or RBG1) (N0SCCM, 1800EEH, bit 1~0)
- └ For NBG1 (or EXBG) (N1SCCM, 1800EEH, bit 3~2)
- └ For NBG2 (N2SCCM, 1800EEH, bit 5~4)
- └ For NBG3 (N3SCCM, 1800EEH, bit 7~6)
- └ For RBG0 (R0SCCM, 1800EEH, bit 9~8)
  - └ 00 : Mode 0 : Select color calculation enable per screen
  - └ 01 : Mode 1 : Select color calculation enable per character
  - └ 10 : Mode 2 : Select color calculation enable per dot
  - └ 11 : Mode 3 : Select color calculation enable per MSB of color data

### Color Calculation Ratio (For Scroll Screen) (xxCCRT, 180108H~18010EH)

- └ For NBG0 (or RBG1) (N0CCRT, 180108H, bit 4~0)
- └ For NBG1 (or EXBG) (N1CCRT, 180108H, bit 12~8)
- └ For NBG2 (N2CCRT, 18010AH, bit 4~0)
- └ For NBG3 (N3CCRT, 18010AH, bit 12~8)
- └ For RBG0 (R0CCRT, 18010CH, bit 4~0)
- └ For LNCL (LCCRT, 18010EH, bit 4~0)
- └ For BACK (BKCCRT, 18010EH, bit 12~8)

## Color Offset

- Color Offset Enable (xxCOEN, 180110H)
  - For NBG0 (or RBG1) (N0COEN, 180110H, bit 0)
  - For NBG1 (or EXBG) (N1COEN, 180110H, bit 1)
  - For NBG2 (N2COEN, 180110H, bit 2)
  - For NBG3 (N3COEN, 180110H, bit 3)
  - For RBG0 (R0COEN, 180110H, bit 4)
  - For BACK (BKCOEN, 180110H, bit 5)
  - For Sprite (SPCOEN, 180110H, bit 6)
    - 0 : Does not use Color Offset Function
    - 1 : Uses Color Offset Function
- Color Offset Select (xxCOSL, 180112H)
  - For NBG0 (or RBG1) (N0COSL, 180112H, bit 0)
  - For NBG1 (or EXBG) (N1COSL, 180112H, bit 1)
  - For NBG2 (N2COSL, 180112H, bit 2)
  - For NBG3 (N3COSL, 180112H, bit 3)
  - For RBG0 (R0COSL, 180112H, bit 4)
  - For BACK (BKCOLS, 180112H, bit 5)
  - For Sprite (SPCOSL, 180112H, bit 6)
    - 0 : Uses value of Color Offset A
    - 1 : Uses value of Color Offset B
- Color Offset Value (COxxx, 180114H~18011EH)
  - For Color Offset A Red Data (COARD, 180114H, bit 8~0)
  - For Color Offset A Green Data (COAGR, 180116H, bit 8~0)
  - For Color Offset A Blue Data (COABL, 180118H, bit 8~0)
  - For Color Offset B Red Data (COARD, 18011AH, bit 8~0)
  - For Color Offset B Green Data (COAGR, 18011CH, bit 8~0)
  - For Color Offset B Blue Data (COABL, 18011EH, bit 8~0)

## Shadow Function

- Shadow Enable (xxSDEN, 1800E2H)
  - For NBG0 (or RBG1) (N0SDEN, 1800E2H, bit 0)
  - For NBG1 (or EXBG) (N1SDEN, 1800E2H, bit 1)
  - For NBG2 (N2SDEN, 1800E2H, bit 2)
  - For NBG3 (N3SDEN, 1800E2H, bit 3)
  - For RBG0 (R0SDEN, 1800E2H, bit 4)
  - For BACK (BKSDEN, 1800E2H, bit 5)
    - 0 : Does not use Shadow Function (Does not add shadow)
    - 1 : Uses Shadow Function (Adds shadow)
- Transparent Shadow Select (TPSDSL, 1800E2H)
  - 0 : Disables Transparent Shadow Sprite
  - 1 : Enables Transparent Shadow Sprite





## Chapter 16 Quick Reference

16.1	Register Map.....	296
16.2	Register Bit List.....	315
16.3	Register Bit Functions.....	328
16.4	Table List.....	389

Quick reference contains registers and VRAM tables as follows:

- (1) Register Map: Shows registers in order of addresses; shows register bit abbreviations.
- (2) Register Bit List: Shows in order of register names; shows register bit names, bit abbreviations, addresses and bit positions.
- (3) Register Bit Functions: Shows register bit functions in order of register address.
- (4) Table List: Shows VRAM table configuration.

## 16.1 Register Map

(A listing of the register maps begin on the next page.)



• **TV SCREEN MODE (READ ALLOWED)**

	15	14	13	12	11	10	9	8
TVMD	DISP	~	~	~	~	~	~	BDCLMD
180000H	7	6	5	4	3	2	1	0
	LSMD1	LSMD0	VRESO1	VRESO0	~	HRESO2	HRESO1	HRESO0

• **EXTERNAL SIGNAL ENABLE REGISTER (READ ALLOWED)**

	15	14	13	12	11	10	9	8
EXTEN	~	~	~	~	~	~	EXLTEN	EXSYEN
180002H	7	6	5	4	3	2	1	0
	~	~	~	~	~	~	DASEL	EXBGEN

• **SCREEN STATUS (READ ONLY)**

	15	14	13	12	11	10	9	8
TVSTAT	~	~	~	~	~	~	EXLTFG	EXSYFG
180004H	7	6	5	4	3	2	1	0
	~	~	~	~	VBLANK	HBLANK	ODD	PAL

• **VRAM SIZE (READ ALLOWED)**

	15	14	13	12	11	10	9	8
VRSIZE	VRAMSZ	~	~	~	~	~	~	~
180006H	7	6	5	4	3	2	1	0
	~	~	~	~	VER3	VER2	VER1	VER0

• **H-COUNTER (READ ONLY)**

	15	14	13	12	11	10	9	8
HCNT	~	~	~	~	~	~	HCT9	HCT8
180008H	7	6	5	4	3	2	1	0
	HCT7	HCT6	HCT5	HCT4	HCT3	HCT2	HCT1	HCT0

• **V-COUNTER (READ ONLY)**

	15	14	13	12	11	10	9	8
VCNT	~	~	~	~	~	~	VCT9	VCT8
18000AH	7	6	5	4	3	2	1	0
	VCT7	VCT6	VCT5	VCT4	VCT3	VCT2	VCT1	VCT0

• **RESERVE**

	15	14	13	12	11	10	9	8
	~	~	~	~	~	~	~	~
18000CH	7	6	5	4	3	2	1	0
	~	~	~	~	~	~	~	~

• **RAM CONTROL (READ ALLOWED)**

	15	14	13	12	11	10	9	8
RAMCTL	~	~	CRMD1	CRMD0	~	~	VRBMD	VRAMD
18000EH	7	6	5	4	3	2	1	0
	RDBSB11	RDBSB10	RDBSB01	RDBSB00	RDBSA11	RDBSA10	RDBSA01	RDBSA00

• **VRAM CYCLE PATTERN (BANK A0)**

	15	14	13	12	11	10	9	8
CYCA0L	VCP0A03	VCP0A02	VCP0A01	VCP0A00	VCP1A03	VCP1A02	VCP1A01	VCP1A00
180010H	7	6	5	4	3	2	1	0
	VCP2A03	VCP2A02	VCP2A01	VCP2A00	VCP3A03	VCP3A02	VCP3A01	VCP3A00

• **VRAM CYCLE PATTERN (BANK A0)**

	15	14	13	12	11	10	9	8
CYCA0U	VCP4A03	VCP4A02	VCP4A01	VCP4A00	VCP5A03	VCP5A02	VCP5A01	VCP5A00
180012H	7	6	5	4	3	2	1	0
	VCP6A03	VCP6A02	VCP6A01	VCP6A00	VCP7A03	VCP7A02	VCP7A01	VCP7A00

• **VRAM CYCLE PATTERN (BANK A1)**

	15	14	13	12	11	10	9	8
CYCA1L	VCP0A13	VCP0A12	VCP0A11	VCP0A10	VCP1A13	VCP1A12	VCP1A11	VCP1A10
180014H	7	6	5	4	3	2	1	0
	VCP2A13	VCP2A12	VCP2A11	VCP2A10	VCP3A13	VCP3A12	VCP3A11	VCP3A10

• **VRAM CYCLE PATTERN (BANK A1)**

	15	14	13	12	11	10	9	8
CYCA1U	VCP4A13	VCP4A12	VCP4A11	VCP4A10	VCP5A13	VCP5A12	VCP5A11	VCP5A10
180016H	7	6	5	4	3	2	1	0
	VCP6A13	VCP6A12	VCP6A11	VCP6A10	VCP7A13	VCP7A12	VCP7A11	VCP7A10

• **VRAM CYCLE PATTERN (BANK B0)**

	15	14	13	12	11	10	9	8
CYCB0L	VCP0B03	VCP0B02	VCP0B01	VCP0B00	VCP1B03	VCP1B02	VCP1B01	VCP1B00
180018H	7	6	5	4	3	2	1	0
	VCP2B03	VCP2B02	VCP2B01	VCP2B00	VCP3B03	VCP3B02	VCP3B01	VCP3B00

• **VRAM CYCLE PATTERN (BANK B0)**

	15	14	13	12	11	10	9	8
CYCB0U	VCP4B03	VCP4B02	VCP4B01	VCP4B00	VCP5B03	VCP5B02	VCP5B01	VCP5B00
18001AH	7	6	5	4	3	2	1	0
	VCP6B03	VCP6B02	VCP6B01	VCP6B00	VCP7B03	VCP7B02	VCP7B01	VCP7B00

• **VRAM CYCLE PATTERN (BANK B1)**

	15	14	13	12	11	10	9	8
CYCB1L	VCP0B13	VCP0B12	VCP0B11	VCP0B10	VCP1B13	VCP1B12	VCP1B11	VCP1B10
18001CH	7	6	5	4	3	2	1	0
	VCP2B13	VCP2B12	VCP2B11	VCP2B10	VCP3B13	VCP3B12	VCP3B11	VCP3B10

• **VRAM CYCLE PATTERN (BANK B1)**

	15	14	13	12	11	10	9	8
CYCB1U	VCP4B13	VCP4B12	VCP4B11	VCP4B10	VCP5B13	VCP5B12	VCP5B11	VCP5B10
18001EH	7	6	5	4	3	2	1	0
	VCP6B13	VCP6B12	VCP6B11	VCP6B10	VCP7B13	VCP7B12	VCP7B11	VCP7B10



• **SCREEN DISPLAY ENABLE**

	15	14	13	12	11	10	9	8
BGON	~	~	~	R0TPON	N3TPON	N2TPON	N1TPON	N0TPON
180020H	7	6	5	4	3	2	1	0
	~	~	R1ON	R0ON	N3ON	N2ON	N1ON	N0ON

• **MOSAIC CONTROL**

	15	14	13	12	11	10	9	8
MZCTL	MZSZV3	MZSZV2	MZSZV1	MZSZV0	MZSZH3	MZSZH2	MZSZH1	MZSZH0
180022H	7	6	5	4	3	2	1	0
	~	~	~	R0MZE	N3MZE	N2MZE	N1MZE	N0MZE

• **SPECIAL FUNCTION CODE SELECT**

	15	14	13	12	11	10	9	8
SFSEL	~	~	~	~	~	~	~	~
180024H	7	6	5	4	3	2	1	0
	~	~	~	R0SFCS	N3SFCS	N2SFCS	N1SFCS	N0SFCS

• **SPECIAL FUNCTION CODE**

	15	14	13	12	11	10	9	8
SFCODE	SFCDB7	SFCDB6	SFCDB5	SFCDB4	SFCDB3	SFCDB2	SFCDB1	SFCDB0
180026H	7	6	5	4	3	2	1	0
	SFCDA7	SFCDA6	SFCDA5	SFCDA4	SFCDA3	SFCDA2	SFCDA1	SFCDA0

• **CHARACTER CONTROL (NBG0, NBG1)**

	15	14	13	12	11	10	9	8
CHCTLA	~	~	N1CHCN1	N1CHCN0	N1BMSZ1	N1BMSZ0	N1BMEN	N1CHSZ
180028H	7	6	5	4	3	2	1	0
	~	NOCHCN2	NOCHCN1	NOCHCN0	NOBMSZ1	NOBMSZ0	NOBMEN	NOCHSZ

• **CHARACTER CONTROL (NBG2, NBG3, RBG0)**

	15	14	13	12	11	10	9	8
CHCTLB	~	R0CHCN2	R0CHCN1	R0CHCN0	~	R0BMSZ	R0BMEN	R0CHSZ
18002AH	7	6	5	4	3	2	1	0
	~	~	N3CHCN	N3CHSZ	~	~	N2CHCN	N2CHSZ

• **BITMAP PALETTE NUMBER (NBGO, NBG1)**

	15	14	13	12	11	10	9	8
BMPNA	~	~	N1BMPR	N1BMCC	~	N1BMP6	N1BMP5	N1BMP4
18002CH	7	6	5	4	3	2	1	0
	~	~	NOBMPR	NOBMCC	~	NOBMP6	NOBMP5	NOBMP4

• **BITMAP PALETTE NUMBER (RBG0)**

	15	14	13	12	11	10	9	8
BMPNB	~	~	~	~	~	~	~	~
18002EH	7	6	5	4	3	2	1	0
	~	~	R0BMPR	R0BMCC	~	R0BMP6	R0BMP5	R0BMP4

• **PATTERN NAME CONTROL (NBG0)**

	15	14	13	12	11	10	9	8
PNCN0	N0PNB	N0CNSM	~	~	~	~	N0SPR	N0SCC
180030H	7	6	5	4	3	2	1	0
	N0SPLT6	N0SPLT5	N0SPLT4	N0SCN4	N0SCN3	N0SCN2	N0SCN1	N0SCN0

• **PATTERN NAME CONTROL (NBG1)**

	15	14	13	12	11	10	9	8
PNCN1	N1PNB	N1CNSM	~	~	~	~	N1SPR	N1SCC
180032H	7	6	5	4	3	2	1	0
	N1SPLT6	N1SPLT5	N1SPLT4	N1SCN4	N1SCN3	N1SCN2	N1SCN1	N1SCN0

• **PATTERN NAME CONTROL (NBG2)**

	15	14	13	12	11	10	9	8
PNCN2	N2PNB	N2CNSM	~	~	~	~	N2SPR	N2SCC
180034H	7	6	5	4	3	2	1	0
	N2SPLT6	N2SPLT5	N2SPLT4	N2SCN4	N2SCN3	N2SCN2	N2SCN1	N2SCN0

• **PATTERN NAME CONTROL (NBG3)**

	15	14	13	12	11	10	9	8
PNCN3	N3PNB	N3CNSM	~	~	~	~	N3SPR	N3SCC
180036H	7	6	5	4	3	2	1	0
	N3SPLT6	N3SPLT5	N3SPLT4	N3SCN4	N3SCN3	N3SCN2	N3SCN1	N3SCN0

• **PATTERN NAME CONTROL (RBG0)**

	15	14	13	12	11	10	9	8
PNCR	R0PNB	R0CNSM	~	~	~	~	R0SPR	R0SCC
180038H	7	6	5	4	3	2	1	0
	R0SPLT6	R0SPLT5	R0SPLT4	R0SCN4	R0SCN3	R0SCN2	R0SCN1	R0SCN0

• **PLANE SIZE**

	15	14	13	12	11	10	9	8
PLSZ	RBOVR1	RBOVR0	RBPLSZ1	RBPLSZ0	RAOVR1	RAOVR0	RAPLSZ1	RAPLSZ0
18003AH	7	6	5	4	3	2	1	0
	N3PLSZ1	N3PLSZ0	N2PLSZ1	N2PLSZ0	N1PLSZ1	N1PLSZ0	N0PLSZ1	N0PLSZ0

• **MAP OFFSET (NBG0~NBG3)**

	15	14	13	12	11	10	9	8
MPOFN	~	N3MP8	N3MP7	N3MP6	~	N2MP8	N2MP7	N2MP6
18003CH	7	6	5	4	3	2	1	0
	~	N1MP8	N1MP7	N1MP6	~	N0MP8	N0MP7	N0MP6

• **MAP OFFSET (ROTATION PARAMETER A,B)**

	15	14	13	12	11	10	9	8
MPOFR	~	~	~	~	~	~	~	~
18003EH	7	6	5	4	3	2	1	0
	~	RBMP8	RBMP7	RBMP6	~	RAMP8	RAMP7	RAMP6



• MAP (NBG0, PLANE A,B)

	15	14	13	12	11	10	9	8
MPABN0	~	~	N0MPB5	N0MPB4	N0MPB3	N0MPB2	N0MPB1	N0MPB0
180040H	7	6	5	4	3	2	1	0
	~	~	N0MPA5	N0MPA4	N0MPA3	N0MPA2	N0MPA1	N0MPA0

• MAP (NBG0, PLANE C,D)

	15	14	13	12	11	10	9	8
MPCDN0	~	~	N0MPD5	N0MPD4	N0MPD3	N0MPD2	N0MPD1	N0MPD0
180042H	7	6	5	4	3	2	1	0
	~	~	N0MPC5	N0MPC4	N0MPC3	N0MPC2	N0MPC1	N0MPC0

• MAP (NBG1, PLANE A,B)

	15	14	13	12	11	10	9	8
MPABN1	~	~	N1MPB5	N1MPB4	N1MPB3	N1MPB2	N1MPB1	N1MPB0
180044H	7	6	5	4	3	2	1	0
	~	~	N1MPA5	N1MPA4	N1MPA3	N1MPA2	N1MPA1	N1MPA0

• MAP (NBG1, PLANE C,D)

	15	14	13	12	11	10	9	8
MPCDN1	~	~	N1MPD5	N1MPD4	N1MPD3	N1MPD2	N1MPD1	N1MPD0
180046H	7	6	5	4	3	2	1	0
	~	~	N1MPC5	N1MPC4	N1MPC3	N1MPC2	N1MPC1	N1MPC0

• MAP (NBG2, PLANE A,B)

	15	14	13	12	11	10	9	8
MPABN2	~	~	N2MPB5	N2MPB4	N2MPB3	N2MPB2	N2MPB1	N2MPB0
180048H	7	6	5	4	3	2	1	0
	~	~	N2MPA5	N2MPA4	N2MPA3	N2MPA2	N2MPA1	N2MPA0

• MAP (NBG2, PLANE C,D)

	15	14	13	12	11	10	9	8
MPCDN2	~	~	N2MPD5	N2MPD4	N2MPD3	N2MPD2	N2MPD1	N2MPD0
18004AH	7	6	5	4	3	2	1	0
	~	~	N2MPC5	N2MPC4	N2MPC3	N2MPC2	N2MPC1	N2MPC0

• MAP (NBG3, PLANE A,B)

	15	14	13	12	11	10	9	8
MPABN3	~	~	N3MPB5	N3MPB4	N3MPB3	N3MPB2	N3MPB1	N3MPB0
18004CH	7	6	5	4	3	2	1	0
	~	~	N3MPA5	N3MPA4	N3MPA3	N3MPA2	N3MPA1	N3MPA0

• MAP (NBG3, PLANE C,D)

	15	14	13	12	11	10	9	8
MPCDN3	~	~	N3MPD5	N3MPD4	N3MPD3	N3MPD2	N3MPD1	N3MPD0
18004EH	7	6	5	4	3	2	1	0
	~	~	N3MPC5	N3MPC4	N3MPC3	N3MPC2	N3MPC1	N3MPC0

• MAP (ROTATION PARAMETER A, PLANE A,B)

	15	14	13	12	11	10	9	8
MPABRA	~	~	RAMPB5	RAMPB4	RAMPB3	RAMPB2	RAMPB1	RAMPB0
180050H	7	6	5	4	3	2	1	0
	~	~	RAMPA5	RAMPA4	RAMPA3	RAMPA2	RAMPA1	RAMPA0

• MAP (ROTATION PARAMETER A, PLANE C,D)

	15	14	13	12	11	10	9	8
MPCDRA	~	~	RAMPD5	RAMPD4	RAMPD3	RAMPD2	RAMPD1	RAMPD0
180052H	7	6	5	4	3	2	1	0
	~	~	RAMPC5	RAMPC4	RAMPC3	RAMPC2	RAMPC1	RAMPC0

• MAP (ROTATION PARAMETER A, PLANE E,F)

	15	14	13	12	11	10	9	8
MPEFRA	~	~	RAMPF5	RAMPF4	RAMPF3	RAMPF2	RAMPF1	RAMPF0
180054	7	6	5	4	3	2	1	0
	~	~	RAMPE5	RAMPE4	RAMPE3	RAMPE2	RAMPE1	RAMPE0

• MAP (ROTATION PARAMETER A, PLANE G,H)

	15	14	13	12	11	10	9	8
MPGHRA	~	~	RAMPH5	RAMPH4	RAMPH3	RAMPH2	RAMPH1	RAMPH0
180056H	7	6	5	4	3	2	1	0
	~	~	RAMPG5	RAMPG4	RAMPG3	RAMPG2	RAMPG1	RAMPG0

• MAP (ROTATION PARAMETER A, PLANE I,J)

	15	14	13	12	11	10	9	8
MPIJRA	~	~	RAMPJ5	RAMPJ4	RAMPJ3	RAMPJ2	RAMPJ1	RAMPJ0
180058H	7	6	5	4	3	2	1	0
	~	~	RAMPI5	RAMPI4	RAMPI3	RAMPI2	RAMPI1	RAMPI0

• MAP (ROTATION PARAMETER A, PLANE K,L)

	15	14	13	12	11	10	9	8
MPKLRA	~	~	RAMPL5	RAMPL4	RAMPL3	RAMPL2	RAMPL1	RAMPL0
18005AH	7	6	5	4	3	2	1	0
	~	~	RAMPK5	RAMPK4	RAMPK3	RAMPK2	RAMPK1	RAMPK0

• MAP (ROTATION PARAMETER A, PLANE M,N)

	15	14	13	12	11	10	9	8
MPMNRA	~	~	RAMPN5	RAMPN4	RAMPN3	RAMPN2	RAMPN1	RAMPN0
18005CH	7	6	5	4	3	2	1	0
	~	~	RAMPM5	RAMPM4	RAMPM3	RAMPM2	RAMPM1	RAMPM0

• MAP (ROTATION PARAMETER A, PLANE O,P)

	15	14	13	12	11	10	9	8
MPOPRA	~	~	RAMPP5	RAMPP4	RAMPP3	RAMPP2	RAMPP1	RAMPP0
18005EH	7	6	5	4	3	2	1	0
	~	~	RAMPO5	RAMPO4	RAMPO3	RAMPO2	RAMPO1	RAMPO0





• MAP (ROTATION PARAMETER B, PLANE A,B)

	15	14	13	12	11	10	9	8
MPABRB	~	~	RBMPB5	RBMPB4	RBMPB3	RBMPB2	RBMPB1	RBMPB0
180060H	7	6	5	4	3	2	1	0
	~	~	RBMPA5	RBMPA4	RBMPA3	RBMPA2	RBMPA1	RBMPA0

• MAP (ROTATION PARAMETER B, PLANE C,D)

	15	14	13	12	11	10	9	8
MPCDRB	~	~	RBMPD5	RBMPD4	RBMPD3	RBMPD2	RBMPD1	RBMPD0
180062H	7	6	5	4	3	2	1	0
	~	~	RBMPC5	RBMPC4	RBMPC3	RBMPC2	RBMPC1	RBMPC0

• MAP (ROTATION PARAMETER B, PLANE E,F)

	15	14	13	12	11	10	9	8
MPEFRB	~	~	RBMPF5	RBMPF4	RBMPF3	RBMPF2	RBMPF1	RBMPF0
180064	7	6	5	4	3	2	1	0
	~	~	RBMPE5	RBMPE4	RBMPE3	RBMPE2	RBMPE1	RBMPE0

• MAP (ROTATION PARAMETER B, PLANE G,H)

	15	14	13	12	11	10	9	8
MPGHRB	~	~	RBMPH5	RBMPH4	RBMPH3	RBMPH2	RBMPH1	RBMPH0
180066H	7	6	5	4	3	2	1	0
	~	~	RBMPG5	RBMPG4	RBMPG3	RBMPG2	RBMPG1	RBMPG0

• MAP (ROTATION PARAMETER B, PLANE I,J)

	15	14	13	12	11	10	9	8
MPIJRB	~	~	RBMPJ5	RBMPJ4	RBMPJ3	RBMPJ2	RBMPJ1	RBMPJ0
180068H	7	6	5	4	3	2	1	0
	~	~	RBMPI5	RBMPI4	RBMPI3	RBMPI2	RBMPI1	RBMPI0

• MAP (ROTATION PARAMETER B, PLANE K,L)

	15	14	13	12	11	10	9	8
MPKLRB	~	~	RBMPK5	RBMPK4	RBMPK3	RBMPK2	RBMPK1	RBMPK0
18006AH	7	6	5	4	3	2	1	0
	~	~	RBMPK5	RBMPK4	RBMPK3	RBMPK2	RBMPK1	RBMPK0

• MAP (ROTATION PARAMETER B, PLANE M,N)

	15	14	13	12	11	10	9	8
MPMNRB	~	~	RBMPN5	RBMPN4	RBMPN3	RBMPN2	RBMPN1	RBMPN0
18006CH	7	6	5	4	3	2	1	0
	~	~	RBMPM5	RBMPM4	RBMPM3	RBMPM2	RBMPM1	RBMPM0

• MAP (ROTATION PARAMETER B, PLANE O,P)

	15	14	13	12	11	10	9	8
MPOPRB	~	~	RBMPPO5	RBMPPO4	RBMPPO3	RBMPPO2	RBMPPO1	RBMPPO0
18006EH	7	6	5	4	3	2	1	0
	~	~	RBMPPO5	RBMPPO4	RBMPPO3	RBMPPO2	RBMPPO1	RBMPPO0

• **SCREEN SCROLL VALUE (NBG0, HORIZONTAL INTEGER PART)**

	15	14	13	12	11	10	9	8
SCXIN0	~	~	~	~	~	N0SCXI10	N0SCXI9	N0SCXI8
180070H	7	6	5	4	3	2	1	0
	N0SCXI7	N0SCXI6	N0SCXI5	N0SCXI4	N0SCXI3	N0SCXI2	N0SCXI1	N0SCXI0

• **SCREEN SCROLL VALUE (NBG0, HORIZONTAL FRACTIONAL PART)**

	15	14	13	12	11	10	9	8
SCXDNO	N0SCXD1	N0SCXD2	N0SCXD3	N0SCXD4	N0SCXD5	N0SCXD6	N0SCXD7	N0SCXD8
180072H	7	6	5	4	3	2	1	0
	~	~	~	~	~	~	~	~

• **SCREEN SCROLL VALUE (NBG0, VERTICAL INTEGER PART)**

	15	14	13	12	11	10	9	8
SCYIN0	~	~	~	~	~	N0SCYI10	N0SCYI9	N0SCYI8
180074H	7	6	5	4	3	2	1	0
	N0SCYI7	N0SCYI6	N0SCYI5	N0SCYI4	N0SCYI3	N0SCYI2	N0SCYI1	N0SCYI0

• **SCREEN SCROLL VALUE (NBG0, VERTICAL FRACTIONAL PART)**

	15	14	13	12	11	10	9	8
SCYDNO	N0SCYD1	N0SCYD2	N0SCYD3	N0SCYD4	N0SCYD5	N0SCYD6	N0SCYD7	N0SCYD8
180076H	7	6	5	4	3	2	1	0
	~	~	~	~	~	~	~	~

• **COORDINATE INCREMENT (NBG0, HORIZONTAL INTEGER PART)**

	15	14	13	12	11	10	9	8
ZMXIN0	~	~	~	~	~	~	~	~
180078H	7	6	5	4	3	2	1	0
	~	~	~	~	~	N0ZMXI2	N0ZMXI1	N0ZMXI0

• **COORDINATE INCREMENT (NBG0, HORIZONTAL FRACTIONAL PART)**

	15	14	13	12	11	10	9	8
ZMXDNO	N0ZMXD1	N0ZMXD2	N0ZMXD3	N0ZMXD4	N0ZMXD5	N0ZMXD6	N0ZMXD7	N0ZMXD8
18007AH	7	6	5	4	3	2	1	0
	~	~	~	~	~	~	~	~

• **COORDINATE INCREMENT (NBG0, VERTICAL INTEGER PART)**

	15	14	13	12	11	10	9	8
ZMYIN0	~	~	~	~	~	~	~	~
18007CH	7	6	5	4	3	2	1	0
	~	~	~	~	~	N0ZMYI2	N0ZMYI1	N0ZMYI0

• **COORDINATE INCREMENT (NBG0, VERTICAL FRACTIONAL PART)**

	15	14	13	12	11	10	9	8
ZMYDNO	N0ZMYD1	N0ZMYD2	N0ZMYD3	N0ZMYD4	N0ZMYD5	N0ZMYD6	N0ZMYD7	N0ZMYD8
18007EH	7	6	5	4	3	2	1	0
	~	~	~	~	~	~	~	~



• **SCREEN SCROLL VALUE (NBG1, HORIZONTAL INTEGER PART)**

	15	14	13	12	11	10	9	8
SCXIN1	~	~	~	~	~	N1SCXI10	N1SCXI9	N1SCXI8
180080H	7	6	5	4	3	2	1	0
	N1SCXI7	N1SCXI6	N1SCXI5	N1SCXI4	N1SCXI3	N1SCXI2	N1SCXI1	N1SCXI0

• **SCREEN SCROLL VALUE (NBG1, HORIZONTAL FRACTIONAL PART)**

	15	14	13	12	11	10	9	8
SCXDN1	N1SCXD1	N1SCXD2	N1SCXD3	N1SCXD4	N1SCXD5	N1SCXD6	N1SCXD7	N1SCXD8
180082H	7	6	5	4	3	2	1	0
	~	~	~	~	~	~	~	~

• **SCREEN SCROLL VALUE (NBG1, VERTICAL INTEGER PART)**

	15	14	13	12	11	10	9	8
SCYIN1	~	~	~	~	~	N1SCYI10	N1SCYI9	N1SCYI8
180084H	7	6	5	4	3	2	1	0
	N1SCYI7	N1SCYI6	N1SCYI5	N1SCYI4	N1SCYI3	N1SCYI2	N1SCYI1	N1SCYI0

• **SCREEN SCROLL VALUE (NBG1, VERTICAL FRACTIONAL PART)**

	15	14	13	12	11	10	9	8
SCYDN1	N1SCYD1	N1SCYD2	N1SCYD3	N1SCYD4	N1SCYD5	N1SCYD6	N1SCYD7	N1SCYD8
180086H	7	6	5	4	3	2	1	0
	~	~	~	~	~	~	~	~

• **COORDINATE INCREMENT (NBG1, HORIZONTAL INTEGER PART)**

	15	14	13	12	11	10	9	8
ZMXIN1	~	~	~	~	~	~	~	~
180088H	7	6	5	4	3	2	1	0
	~	~	~	~	~	N1ZMXI2	N1ZMXI1	N1ZMXI0

• **COORDINATE INCREMENT (NBG1, HORIZONTAL FRACTIONAL PART)**

	15	14	13	12	11	10	9	8
ZMXDN1	N1ZMXD1	N1ZMXD2	N1ZMXD3	N1ZMXD4	N1ZMXD5	N1ZMXD6	N1ZMXD7	N1ZMXD8
18008AH	7	6	5	4	3	2	1	0
	~	~	~	~	~	~	~	~

• **COORDINATE INCREMENT (NBG1, VERTICAL INTEGER PART)**

	15	14	13	12	11	10	9	8
ZMYIN1	~	~	~	~	~	~	~	~
18008CH	7	6	5	4	3	2	1	0
	~	~	~	~	~	N1ZMYI2	N1ZMYI1	N1ZMYI0

• **COORDINATE INCREMENT (NBG1, VERTICAL FRACTIONAL PART)**

	15	14	13	12	11	10	9	8
ZMYDN1	N1ZMYD1	N1ZMYD2	N1ZMYD3	N1ZMYD4	N1ZMYD5	N1ZMYD6	N1ZMYD7	N1ZMYD8
18008EH	7	6	5	4	3	2	1	0
	~	~	~	~	~	~	~	~

• **SCREEN SCROLL VALUE (NBG2, HORIZONTAL)**

	15	14	13	12	11	10	9	8
SCXN2	~	~	~	~	~	N2SCX10	N2SCX9	N2SCX8
180090H	7	6	5	4	3	2	1	0
	N2SCX7	N2SCX6	N2SCX5	N2SCX4	N2SCX3	N2SCX2	N2SCX1	N2SCX0

• **SCREEN SCROLL VALUE (NBG2, VERTICAL)**

	15	14	13	12	11	10	9	8
SCYN2	~	~	~	~	~	N2SCY10	N2SCY9	N2SCY8
180092H	7	6	5	4	3	2	1	0
	N2SCY7	N2SCY6	N2SCY5	N2SCY4	N2SCY3	N2SCY2	N2SCY1	N2SCY0

• **SCREEN SCROLL VALUE (NBG3, HORIZONTAL)**

	15	14	13	12	11	10	9	8
SCXN3	~	~	~	~	~	N3SCX10	N3SCX9	N3SCX8
180094H	7	6	5	4	3	2	1	0
	N3SCX7	N3SCX6	N3SCX5	N3SCX4	N3SCX3	N3SCX2	N3SCX1	N3SCX0

• **SCREEN SCROLL VALUE (NBG3, VERTICAL)**

	15	14	13	12	11	10	9	8
SCYN3	~	~	~	~	~	N3SCY10	N3SCY9	N3SCY8
180096H	7	6	5	4	3	2	1	0
	N3SCY7	N3SCY6	N3SCY5	N3SCY4	N3SCY3	N3SCY2	N3SCY1	N3SCY0

• **REDUCTION ENABLE**

	15	14	13	12	11	10	9	8
ZMCTL	~	~	~	~	~	~	N1ZMQT	N1ZMHF
180098H	7	6	5	4	3	2	1	0
	~	~	~	~	~	~	N0ZMQT	N0ZMHF

• **LINE AND VERTICAL CELL SCROLL CONTROL (NBGO, NBG1)**

	15	14	13	12	11	10	9	8
SCRCTL	~	~	N1LSS1	N1LSS0	N1LZMX	N1LSCY	N1LSCX	N1VCSC
18009AH	7	6	5	4	3	2	1	0
	~	~	N0LSS1	N0LSS0	N0LZMX	N0LSCY	N0LSCX	N0VCSC

• **VERTICAL CELL SCROLL TABLE ADDRESS (NBGO, NBG1)**

	15	14	13	12	11	10	9	8
VCSTAU	~	~	~	~	~	~	~	~
18009CH	7	6	5	4	3	2	1	0
	~	~	~	~	~	VCSTA18	VCSTA17	VCSTA16

• **VERTICAL CELL SCROLL TABLE ADDRESS (NBGO, NBG1)**

	15	14	13	12	11	10	9	8
VCSTAL	VCSTA15	VCSTA14	VCSTA13	VCSTA12	VCSTA11	VCSTA10	VCSTA9	VCSTA8
18009EH	7	6	5	4	3	2	1	0
	VCSTA7	VCSTA6	VCSTA5	VCSTA4	VCSTA3	VCSTA2	VCSTA1	~



• **LINE SCROLL TABLE ADDRESS (NBGO)**

	15	14	13	12	11	10	9	8
LSTA0U	~	~	~	~	~	~	~	~
1800A0H	7	6	5	4	3	2	1	0
	~	~	~	~	~	NOLSTA18	NOLSTA17	NOLSTA16

• **LINE SCROLL TABLE ADDRESS (NBGO)**

	15	14	13	12	11	10	9	8
LSTA0L	NOLSTA15	NOLSTA14	NOLSTA13	NOLSTA12	NOLSTA11	NOLSTA10	NOLSTA9	NOLSTA8
1800A2H	7	6	5	4	3	2	1	0
	NOLSTA7	NOLSTA6	NOLSTA5	NOLSTA4	NOLSTA3	NOLSTA2	NOLSTA1	~

• **LINE SCROLL TABLE ADDRESS (NBG1)**

	15	14	13	12	11	10	9	8
LSTA1U	~	~	~	~	~	~	~	~
1800A4H	7	6	5	4	3	2	1	0
	~	~	~	~	~	N1LSTA18	N1LSTA17	N1LSTA16

• **LINE SCROLL TABLE ADDRESS (NBG1)**

	15	14	13	12	11	10	9	8
LSTA1L	N1LSTA15	N1LSTA14	N1LSTA13	N1LSTA12	N1LSTA11	N1LSTA10	N1LSTA9	N1LSTA8
1800A6H	7	6	5	4	3	2	1	0
	N1LSTA7	N1LSTA6	N1LSTA5	N1LSTA4	N1LSTA3	N1LSTA2	N1LSTA1	~

• **LINE COLOR SCREEN TABLE ADDRESS**

	15	14	13	12	11	10	9	8
LCTAU	LCCLMD	~	~	~	~	~	~	~
1800A8H	7	6	5	4	3	2	1	0
	~	~	~	~	~	LCTA18	LCTA17	LCTA16

• **LINE COLOR SCREEN TABLE ADDRESS**

	15	14	13	12	11	10	9	8
LCTAL	LCTA15	LCTA14	LCTA13	LCTA12	LCTA11	LCTA10	LCTA9	LCTA8
1800AAH	7	6	5	4	3	2	1	0
	LCTA7	LCTA6	LCTA5	LCTA4	LCTA3	LCTA2	LCTA1	LCTA0

• **BACK SCREEN TABLE ADDRESS**

	15	14	13	12	11	10	9	8
BKTAU	BKCLMD	~	~	~	~	~	~	~
1800ACH	7	6	5	4	3	2	1	0
	~	~	~	~	~	BKTA18	BKTA17	BKTA16

• **BACK SCREEN TABLE ADDRESS**

	15	14	13	12	11	10	9	8
BKTAL	BKTA15	BKTA14	BKTA13	BKTA12	BKTA11	BKTA10	BKTA9	BKTA8
1800AEH	7	6	5	4	3	2	1	0
	BKTA7	BKTA6	BKTA5	BKTA4	BKTA3	BKTA2	BKTA1	BKTA0

• **ROTATION PARAMETER MODE**

	15	14	13	12	11	10	9	8
RPM D	~	~	~	~	~	~	~	~
1800B0H	7	6	5	4	3	2	1	0
	~	~	~	~	~	~	RPMD1	RPMD0

• **ROTATION PARAMETER READ CONTROL**

	15	14	13	12	11	10	9	8
RPRCTL	~	~	~	~	~	RBKASTRE	RBYSTRE	RBXSTRE
1800B2H	7	6	5	4	3	2	1	0
	~	~	~	~	~	RAKASTRE	RAYSTRE	RAXSTRE

• **COEFFICIENT TABLE CONTROL**

	15	14	13	12	11	10	9	8
KTCTL	~	~	~	RBKLCE	RBKMD1	RBKMD0	RBKDBS	RBKTE
1800B4H	7	6	5	4	3	2	1	0
	~	~	~	RAKLCE	RAKMD1	RAKMD0	RAKDBS	RAKTE

• **COEFFICIENT TABLE ADDRESS OFFSET (ROTATION PARAMETER A, B)**

	15	14	13	12	11	10	9	8
KTAOF	~	~	~	~	~	RBKTAOS2	RBKTAOS1	RBKTAOS0
1800B6H	7	6	5	4	3	2	1	0
	~	~	~	~	~	RAKTAOS2	RAKTAOS1	RAKTAOS0

• **SCREEN OVER PATTERN NAME (ROTATION PARAMETER A)**

	15	14	13	12	11	10	9	8
OVPNRA	RAOPN15	RAOPN14	RAOPN13	RAOPN12	RAOPN11	RAOPN10	RAOPN9	RAOPN8
1800B8H	7	6	5	4	3	2	1	0
	RAOPN7	RAOPN6	RAOPN5	RAOPN4	RAOPN3	RAOPN2	RAOPN1	RAOPN0

• **SCREEN OVER PATTERN NAME (ROTATION PARAMETER B)**

	15	14	13	12	11	10	9	8
OVPNRB	RBOPN15	RBOPN14	RBOPN13	RBOPN12	RBOPN11	RBOPN10	RBOPN9	RBOPN8
1800BAH	7	6	5	4	3	2	1	0
	RBOPN7	RBOPN6	RBOPN5	RBOPN4	RBOPN3	RBOPN2	RBOPN1	RBOPN0

• **ROTATION PARAMETER TABLE ADDRESS (ROTATION PARAMETER A,B)**

	15	14	13	12	11	10	9	8
RPTAU	~	~	~	~	~	~	~	~
1800BCH	7	6	5	4	3	2	1	0
	~	~	~	~	~	RPTA18	RPTA17	RPTA16

• **ROTATION PARAMETER TABLE ADDRESS (ROTATION PARAMETER A, B)**

	15	14	13	12	11	10	9	8
RPTAL	RPTA15	RPTA14	RPTA13	RPTA12	RPTA11	RPTA10	RPTA9	RPTA8
1800BEH	7	6	5	4	3	2	1	0
	RPTA7	RPTA6	RPTA5	RPTA4	RPTA3	RPTA2	RPTA1	~



• **WINDOW POSITION (W0, HORIZONTAL START POINT)**

	15	14	13	12	11	10	9	8
WPSX0	~	~	~	~	~	~	W0SX9	W0SX8
1800C0H	7	6	5	4	3	2	1	0
	W0SX7	W0SX6	W0SX5	W0SX4	W0SX3	W0SX2	W0SX1	W0SX0

• **WINDOW POSITION (W0, VERTICAL START POINT)**

	15	14	13	12	11	10	9	8
WPSY0	~	~	~	~	~	~	~	W0SY8
1800C2H	7	6	5	4	3	2	1	0
	W0SY7	W0SY6	W0SY5	W0SY4	W0SY3	W0SY2	W0SY1	W0SY0

• **WINDOW POSITION (W0, HORIZONTAL END POINT)**

	15	14	13	12	11	10	9	8
WPEX0	~	~	~	~	~	~	W0EX9	W0EX8
1800C4H	7	6	5	4	3	2	1	0
	W0EX7	W0EX6	W0EX5	W0EX4	W0EX3	W0EX2	W0EX1	W0EX0

• **WINDOW POSITION (W0, VERTICAL END POINT)**

	15	14	13	12	11	10	9	8
WPEY0	~	~	~	~	~	~	~	W0EY8
1800C6H	7	6	5	4	3	2	1	0
	W0EY7	W0EY6	W0EY5	W0EY4	W0EY3	W0EY2	W0EY1	W0EY0

• **WINDOW POSITION (W1, HORIZONTAL START POINT)**

	15	14	13	12	11	10	9	8
WPSX1	~	~	~	~	~	~	W1SX9	W1SX8
1800C8H	7	6	5	4	3	2	1	0
	W1SX7	W1SX6	W1SX5	W1SX4	W1SX3	W1SX2	W1SX1	W1SX0

• **WINDOW POSITION (W1, VERTICAL START POINT)**

	15	14	13	12	11	10	9	8
WPSY1	~	~	~	~	~	~	~	W1SY8
1800CAH	7	6	5	4	3	2	1	0
	W1SY7	W1SY6	W1SY5	W1SY4	W1SY3	W1SY2	W1SY1	W1SY0

• **WINDOW POSITION (W1, HORIZONTAL END POINT)**

	15	14	13	12	11	10	9	8
WPEX1	~	~	~	~	~	~	W1EX9	W1EX8
1800CCH	7	6	5	4	3	2	1	0
	W1EX7	W1EX6	W1EX5	W1EX4	W1EX3	W1EX2	W1EX1	W1EX0

• **WINDOW POSITION (W1, VERTICAL END POINT)**

	15	14	13	12	11	10	9	8
WPEY1	~	~	~	~	~	~	~	W1EY8
1800CEH	7	6	5	4	3	2	1	0
	W1EY7	W1EY6	W1EY5	W1EY4	W1EY3	W1EY2	W1EY1	W1EY0

• **WINDOW CONTROL (NBG0, NBG1)**

	15	14	13	12	11	10	9	8
WCTLA	N1LOG	~	N1SWE	N1SWA	N1W1E	N1W1A	N1W0E	N1W0A
1800D0H	7	6	5	4	3	2	1	0
	N0LOG	~	N0SWE	N0SWA	N0W1E	N0W1A	N0W0E	N0W0A

• **WINDOW CONTROL (NBG2, NBG3)**

	15	14	13	12	11	10	9	8
WCTLB	N3LOG	~	N3SWE	N3SWA	N3W1E	N3W1A	N3W0E	N3W0A
1800D2H	7	6	5	4	3	2	1	0
	N2LOG	~	N2SWE	N2SWA	N2W1E	N2W1A	N2W0E	N2W0A

• **WINDOW CONTROL (RBG0, SPRITE)**

	15	14	13	12	11	10	9	8
WCTLC	SPLOG	~	SPSWE	SPSWA	SPW1E	SPW1A	SPW0E	SPW0A
1800D4H	7	6	5	4	3	2	1	0
	R0LOG	~	R0SWE	R0SWA	R0W1E	R0W1A	R0W0E	R0W0A

• **WINDOW CONTROL (PARAMETER WINDOW, COLOR CALC. WINDOW)**

	15	14	13	12	11	10	9	8
WCTLD	CCLOG	~	CCSWE	CCSWA	CCW1E	CCW1A	CCW0E	CCW0A
1800D6H	7	6	5	4	3	2	1	0
	RPLOG	~	~	~	RPW1E	RPW1A	RPW0E	RPW0A

• **LINE WINDOW TABLE ADDRESS (W0)**

	15	14	13	12	11	10	9	8
LWTA0U	W0LWE	~	~	~	~	~	~	~
1800D8H	7	6	5	4	3	2	1	0
	~	~	~	~	~	W0LWTA18	W0LWTA17	W0LWTA16

• **LINE WINDOW TABLE ADDRESS (W0)**

	15	14	13	12	11	10	9	8
LWTA0L	W0LWTA15	W0LWTA14	W0LWTA13	W0LWTA12	W0LWTA11	W0LWTA10	W0LWTA9	W0LWTA8
1800DAH	7	6	5	4	3	2	1	0
	W0LWTA7	W0LWTA6	W0LWTA5	W0LWTA4	W0LWTA3	W0LWTA2	W0LWTA1	~

• **LINE WINDOW TABLE ADDRESS (W1)**

	15	14	13	12	11	10	9	8
LWTA1U	W1LWE	~	~	~	~	~	~	~
1800DCH	7	6	5	4	3	2	1	0
	~	~	~	~	~	W1LWTA18	W1LWTA17	W1LWTA16

• **LINE WINDOW TABLE ADDRESS (W1)**

	15	14	13	12	11	10	9	8
LWTA1L	W1LWTA15	W1LWTA14	W1LWTA13	W1LWTA12	W1LWTA11	W1LWTA10	W1LWTA9	W1LWTA8
1800DEH	7	6	5	4	3	2	1	0
	W1LWTA7	W1LWTA6	W1LWTA5	W1LWTA4	W1LWTA3	W1LWTA2	W1LWTA1	~





• **SPRITE CONTROL**

	15	14	13	12	11	10	9	8
SPCTL	~	~	SPCCCS1	SPCCCS0	~	SPCCN2	SPCCN1	SPCCN0
1800E0H	7	6	5	4	3	2	1	0
	~	~	SPCLMD	SPWINEN	SPTYPE3	SPTYPE2	SPTYPE1	SPTYPE0

• **SHADOW CONTROL**

	15	14	13	12	11	10	9	8
SDCTL	~	~	~	~	~	~	~	TPSDSL
1800E2H	7	6	5	4	3	2	1	0
	~	~	BKSDEN	R0SDEN	N3SDEN	N2SDEN	N1SDEN	N0SDEN

• **COLOR RAM ADDRESS OFFSET (NBG0~NBG3)**

	15	14	13	12	11	10	9	8
CRAOFA	~	N3CAOS2	N3CAOS1	N3CAOS0	~	N2CAOS2	N2CAOS1	N2CAOS0
1800E4H	7	6	5	4	3	2	1	0
	~	N1CAOS2	N1CAOS1	N1CAOS0	~	N0CAOS2	N0CAOS1	N0CAOS0

• **COLOR RAM ADDRESS OFFSET (RBG0, SPRITE)**

	15	14	13	12	11	10	9	8
CRAOFB	~	~	~	~	~	~	~	~
1800E6H	7	6	5	4	3	2	1	0
	~	SPCAOS2	SPCAOS1	SPCAOS0	~	R0CAOS2	R0CAOS1	R0CAOS0

• **LINE COLOR SCREEN ENABLE**

	15	14	13	12	11	10	9	8
LNCLEN	~	~	~	~	~	~	~	~
1800E8H	7	6	5	4	3	2	1	0
	~	~	SPLCEN	R0LCEN	N3LCEN	N2LCEN	N1LCEN	N0LCEN

• **SPECIAL PRIORITY MODE**

	15	14	13	12	11	10	9	8
SFPRMD	~	~	~	~	~	~	R0SPRM1	R0SPRM0
1800EAH	7	6	5	4	3	2	1	0
	N3SPRM1	N3SPRM0	N2SPRM1	N2SPRM0	N1SPRM1	N1SPRM0	N0SPRM1	N0SPRM0

• **COLOR CALCULATION CONTROL**

	15	14	13	12	11	10	9	8
CCCTL	BOKEN	BOKN2	BOKN1	BOKN0	~	EXCCEN	CCRTMD	CCMD
1800ECH	7	6	5	4	3	2	1	0
	~	SPCCEN	LCCEN	R0CCEN	N3CCEN	N2CCEN	N1CCEN	N0CCEN

• **SPECIAL COLOR CALCULATION MODE**

	15	14	13	12	11	10	9	8
SFCCMD	~	~	~	~	~	~	R0SCCM1	R0SCCM0
1800EEH	7	6	5	4	3	2	1	0
	N3SCCM1	N3SCCM0	N2SCCM1	N2SCCM0	N1SCCM1	N1SCCM0	N0SCCM1	N0SCCM0

• **PRIORITY NUMBER (SPRITE 0,1)**

	15	14	13	12	11	10	9	8
PRISA	~	~	~	~	~	S1PRIN2	S1PRIN1	S1PRIN0
1800F0H	7	6	5	4	3	2	1	0
	~	~	~	~	~	S0PRIN2	S0PRIN1	S0PRIN0

• **PRIORITY NUMBER (SPRITE 2,3)**

	15	14	13	12	11	10	9	8
PRISB	~	~	~	~	~	S3PRIN2	S3PRIN1	S3PRIN0
1800F2H	7	6	5	4	3	2	1	0
	~	~	~	~	~	S2PRIN2	S2PRIN1	S2PRIN0

• **PRIORITY NUMBER (SPRITE 4,5)**

	15	14	13	12	11	10	9	8
PRISC	~	~	~	~	~	S5PRIN2	S5PRIN1	S5PRIN0
1800F4H	7	6	5	4	3	2	1	0
	~	~	~	~	~	S4PRIN2	S4PRIN1	S4PRIN0

• **PRIORITY NUMBER (SPRITE 6,7)**

	15	14	13	12	11	10	9	8
PRISD	~	~	~	~	~	S7PRIN2	S7PRIN1	S7PRIN0
1800F6H	7	6	5	4	3	2	1	0
	~	~	~	~	~	S6PRIN2	S6PRIN1	S6PRIN0

• **PRIORITY NUMBER (NBG0, NBG1)**

	15	14	13	12	11	10	9	8
PRINA	~	~	~	~	~	N1PRIN2	N1PRIN1	N1PRIN0
1800F8H	7	6	5	4	3	2	1	0
	~	~	~	~	~	N0PRIN2	N0PRIN1	N0PRIN0

• **PRIORITY NUMBER (NBG2, NBG3)**

	15	14	13	12	11	10	9	8
PRINB	~	~	~	~	~	N3PRIN2	N3PRIN1	N3PRIN0
1800FAH	7	6	5	4	3	2	1	0
	~	~	~	~	~	N2PRIN2	N2PRIN1	N2PRIN0

• **PRIORITY NUMBER (RBG0)**

	15	14	13	12	11	10	9	8
PRIR	~	~	~	~	~	~	~	~
1800FCH	7	6	5	4	3	2	1	0
	~	~	~	~	~	R0PRIN2	R0PRIN1	R0PRIN0

• **RESERVE**

	15	14	13	12	11	10	9	8
	~	~	~	~	~	~	~	~
1800FEH	7	6	5	4	3	2	1	0
	~	~	~	~	~	~	~	~



• **COLOR CALCULATION RATIO (SPRITE 0,1)**

	15	14	13	12	11	10	9	8
CCRSA	~	~	~	S1CCRT4	S1CCRT3	S1CCRT2	S1CCRT1	S1CCRT0
180100H	7	6	5	4	3	2	1	0
	~	~	~	S0CCRT4	S0CCRT3	S0CCRT2	S0CCRT1	S0CCRT0

• **COLOR CALCULATION RATIO (SPRITE 2,3)**

	15	14	13	12	11	10	9	8
CCRSB	~	~	~	S3CCRT4	S3CCRT3	S3CCRT2	S3CCRT1	S3CCRT0
180102H	7	6	5	4	3	2	1	0
	~	~	~	S2CCRT4	S2CCRT3	S2CCRT2	S2CCRT1	S2CCRT0

• **COLOR CALCULATION RATIO (SPRITE 4,5)**

	15	14	13	12	11	10	9	8
CCRSC	~	~	~	S5CCRT4	S5CCRT3	S5CCRT2	S5CCRT1	S5CCRT0
180104H	7	6	5	4	3	2	1	0
	~	~	~	S4CCRT4	S4CCRT3	S4CCRT2	S4CCRT1	S4CCRT0

• **COLOR CALCULATION RATIO (SPRITE 6,7)**

	15	14	13	12	11	10	9	8
CCRSD	~	~	~	S7CCRT4	S7CCRT3	S7CCRT2	S7CCRT1	S7CCRT0
180106H	7	6	5	4	3	2	1	0
	~	~	~	S6CCRT4	S6CCRT3	S6CCRT2	S6CCRT1	S6CCRT0

• **COLOR CALCULATION RATIO (NBG0, NBG1)**

	15	14	13	12	11	10	9	8
CCRNA	~	~	~	N1CCRT4	N1CCRT3	N1CCRT2	N1CCRT1	N1CCRT0
180108H	7	6	5	4	3	2	1	0
	~	~	~	N0CCRT4	N0CCRT3	N0CCRT2	N0CCRT1	N0CCRT0

• **COLOR CALCULATION RATIO (NBG2, NBG3)**

	15	14	13	12	11	10	9	8
CCRNB	~	~	~	N3CCRT4	N3CCRT3	N3CCRT2	N3CCRT1	N3CCRT0
18010AH	7	6	5	4	3	2	1	0
	~	~	~	N2CCRT4	N2CCRT3	N2CCRT2	N2CCRT1	N2CCRT0

• **COLOR CALCULATION RATIO (RBG0)**

	15	14	13	12	11	10	9	8
CCRR	~	~	~	~	~	~	~	~
18010CH	7	6	5	4	3	2	1	0
	~	~	~	R0CCRT4	R0CCRT3	R0CCRT2	R0CCRT1	R0CCRT0

• **COLOR CALCULATION RATIO (LINE COLOR SCREEN, BACK SCREEN)**

	15	14	13	12	11	10	9	8
CCRLB	~	~	~	BKCCRT4	BKCCRT3	BKCCRT2	BKCCRT1	BKCCRT0
18010EH	7	6	5	4	3	2	1	0
	~	~	~	LCCRT4	LCCRT3	LCCRT2	LCCRT1	LCCRT0

• **COLOR OFFSET ENABLE**

	15	14	13	12	11	10	9	8
CLOFEN	~	~	~	~	~	~	~	~
180110H	7	6	5	4	3	2	1	0
	~	SPCOEN	BKCOEN	R0COEN	N3COEN	N2COEN	N1COEN	N0COEN

• **COLOR OFFSET SELECT**

	15	14	13	12	11	10	9	8
CLOFSL	~	~	~	~	~	~	~	~
180112H	7	6	5	4	3	2	1	0
	~	SPCOSL	BKCOSL	R0COSL	N3COSL	N2COSL	N1COSL	N0COSL

• **COLOR OFFSET A (RED)**

	15	14	13	12	11	10	9	8
COAR	~	~	~	~	~	~	~	COARD8
180114H	7	6	5	4	3	2	1	0
	COARD7	COARD6	COARD5	COARD4	COARD3	COARD2	COARD1	COARD0

• **COLOR OFFSET A (GREEN)**

	15	14	13	12	11	10	9	8
COAG	~	~	~	~	~	~	~	COAGR8
180116H	7	6	5	4	3	2	1	0
	COAGR7	COAGR6	COAGR5	COAGR4	COAGR3	COAGR2	COAGR1	COAGR0

• **COLOR OFFSET A (BLUE)**

	15	14	13	12	11	10	9	8
COAB	~	~	~	~	~	~	~	COABL8
180118H	7	6	5	4	3	2	1	0
	COABL7	COABL6	COABL5	COABL4	COABL3	COABL2	COABL1	COABL0

• **COLOR OFFSET B (RED)**

	15	14	13	12	11	10	9	8
COBR	~	~	~	~	~	~	~	COBRD8
18011AH	7	6	5	4	3	2	1	0
	COBRD7	COBRD6	COBRD5	COBRD4	COBRD3	COBRD2	COBRD1	COBRD0

• **COLOR OFFSET B (GREEN)**

	15	14	13	12	11	10	9	8
COBG	~	~	~	~	~	~	~	COBGR8
18011CH	7	6	5	4	3	2	1	0
	COBGR7	COBGR6	COBGR5	COBGR4	COBGR3	COBGR2	COBGR1	COBGR0

• **COLOR OFFSET B (BLUE)**

	15	14	13	12	11	10	9	8
COBB	~	~	~	~	~	~	~	COBBL8
18011EH	7	6	5	4	3	2	1	0
	COBBL7	COBBL6	COBBL5	COBBL4	COBBL3	COBBL2	COBBL1	COBBL0



## 16.2 Register Bit List

Bit Name	Bit Abbreviation	Address	Bit	Application
• TV Screen Mode				
TV Screen Display	DISP	180000H	15	
Boarder Color Mode	BDCLMD	180000H	8	
Interlace Mode	LSMD	180000H	7,6	
Vertical Definition	VRESO	180000H	5,4	
Horizontal Definition	HRESO	180000H	2~0	
• External Signal Enable				
External Latch Enable	EXLTEN	180002H	9	
External Sync Enable	EXSYEN	180002H	8	
Image Display Area Select	DASEL	180002H	1	
External Screen Enable	EXBGEN	180002H	0	
• Screen Status (Read Only)				
External Latch Flag	EXLTFG	180004H	9	
External Sync Flag	EXSYFG	180004H	8	
V Blank Flag	VBLANK	180004H	3	
H Blank Flag	HBLANK	180004H	2	
Scan Field Flag	ODD	180004H	1	
TV System Flag	PAL	180004H	0	
• VRAM Size (Version Number is Read Only)				
VRAM Size	VRAMSZ	180006H	15	
Version Number	VER	180006H	3~0	
• H-Counter (Read Only)				
H Counter Value	HCT	180008H	9~0	
• V-Counter (Read Only)				
V Counter Value	VCT	18000AH	9~0	
• RAM Control				
Color RAM Mode	CRMD	18000EH	13,12	
VRAM Mode	VRAMD	18000EH	8	For VRAM-A
VRAM Mode	VRBMD	18000EH	9	For VRAM-B
Rotation Data Bank Selection	RDBSA0	18000EH	1,0	For VRAM-A0 (or VRAM-A)
Rotation Data Bank Selection	RDBSA1	18000EH	3,2	For VRAM-A1
Rotation Data Bank Selection	RDBSB0	18000EH	5,4	For VRAM-B0 (or VRAM-B)
Rotation Data Bank Selection	RDBSB1	18000EH	7,6	For VRAM-B1

Bit Name	Bit Abbreviation	Address	Bit	Application
<b>• VRAM Cycle Pattern</b>				
VRAM Cycle Pattern	VCPA0	180010H	15~0	For VRAM-A0
		180012H	15~0	For VRAM-A0
VRAM Cycle Pattern	VCPA1	180014H	15~0	For VRAM-A1
		180016H	15~0	For VRAM-A1
VRAM Cycle Pattern	VCPB0	180018H	15~0	For VRAM-B0
		18001AH	15~0	For VRAM-B0
VRAM Cycle Pattern	VCPB1	18001CH	15~0	For VRAM-B1
		18001EH	15~0	For VRAM-B1
<b>• Screen Display Enable</b>				
Transparent Display Enable	N0TPON	180020H	8	For NBG0 (or RBG0)
Transparent Display Enable	N1TPON	180020H	9	For NBG1 (or EXBG)
Transparent Display Enable	N2TPON	180020H	10	For NBG2
Transparent Display Enable	N3TPON	180020H	11	For NBG3
Transparent Display Enable	R0TPON	180020H	12	For RBG0
Screen Display Enable	N0ON	180020H	0	For NBG0
Screen Display Enable	N1ON	180020H	1	For NBG1
Screen Display Enable	N2ON	180020H	2	For NBG2
Screen Display Enable	N3ON	180020H	3	For NBG3
Screen Display Enable	R0ON	180020H	4	For RBG0
Screen Display Enable	R1ON	180020H	5	For RBG1
<b>• Mosaic Control</b>				
Mosaic Enable	N0MZE	180022H	0	For NBG0 (or RBG1)
Mosaic Enable	N1MZE	180022H	1	For NBG1
Mosaic Enable	N2MZE	180022H	2	For NBG2
Mosaic Enable	N3MZE	180022H	3	For NBG3
Mosaic Enable	R0MZE	180022H	4	For RBG0
Mosaic Size	MZSZH	180022H	11~8	For Horizontal Mosaic Size
Mosaic Size	MZSZV	180022H	15~12	For Vertical Mosaic Size
<b>• Special Function Code Select</b>				
Special Function Code Select	N0SFCS	180024H	0	For NBG0 (or RBG1)
Special Function Code Select	N1SFCS	180024H	1	For NBG1
Special Function Code Select	N2SFCS	180024H	2	For NBG2
Special Function Code Select	N3SFCS	180024H	3	For NBG3
Special Function Code Select	R0SFCS	180024H	4	For RBG0
<b>• Special Function Code</b>				
Special Function	SFCDA	180026H	7~0	For Special Function Code A
Special Function	SFCDB	180026H	15~8	For Special Function Code B



Bit Name	Bit Abbreviation	Address	Bit	Application
• Character Control				
Character Size	N0CHSZ	180028H	0	For NBG0 (or RBG1)
Character Size	N1CHSZ	180028H	8	For NBG1
Character Size	N2CHSZ	18002AH	0	For NBG2
Character Size	N3CHSZ	18002AH	4	For NBG3
Character Size	R0CHSZ	18002AH	8	For RBG0
Bitmap Enable	N0BMEN	180028H	1	For NBG0
Bitmap Enable	N1BMEN	180028H	9	For NBG1
Bitmap Enable	R0BMEN	18002AH	9	For RBG0
Bitmap Size	N0BMSZ	180028H	3,2	For NBG0
Bitmap Size	N1BMSZ	180028H	11,10	For NBG1
Bitmap Size	R0BMSZ	18002AH	10	For RBG0
Number of Character Colors	N0CHCN	180028H	6~4	For NBG0 (or RBG1)
Number of Character Colors	N1CHCN	180028H	13,12	For NBG1 (or EXBG)
Number of Character Colors	N2CHCN	18002AH	1	For NBG2
Number of Character Colors	N3CHCN	18002AH	5	For NBG3
Number of Character Colors	R0CHCN	18002AH	14,12	For RBG0
• Bitmap Palette Number				
Special Priority (for Bitmap)	N0BMPR	18002CH	5	For NBG0
Special Priority (for Bitmap)	N1BMPR	18002CH	13	For NBG1
Special Priority (for Bitmap)	R0BMPR	18002EH	5	For RBG0
Special Color Calculation (for Bitmap)	N0BMCC	18002CH	4	For NBG0
Special Color Calculation (for Bitmap)	N1BMCC	18002CH	12	For NBG1
Special Color Calculation (for Bitmap)	R0BMCC	18002EH	4	For RBG0
Palette Number (for Bitmap)	N0BMP	18002CH	2~0	For NBG0
Palette Number (for Bitmap)	N1BMP	18002CH	10~8	For NBG1
Palette Number (for Bitmap)	R0BMP	18002EH	2~0	For RBG0
• Pattern Name Control				
Pattern Name Data Size	N0PNB	180030H	15	For NBG0 (or RBG1)
Pattern Name Data Size	N1PNB	180032H	15	For NBG1
Pattern Name Data Size	N2PNB	180034H	15	For NBG2
Pattern Name Data Size	N3PNB	180036H	15	For NBG3
Pattern Name Data Size	R0PNB	180038H	15	For RBG0
Character Number Supplement Mode	N0CNSM	180030H	14	For NBG0 (or RBG1)
Character Number Supplement Mode	N1CNSM	180032H	14	For NBG1
Character Number Supplement Mode	N2CNSM	180034H	14	For NBG2
Character Number Supplement Mode	N3CNSM	180036H	14	For NBG3
Character Number Supplement Mode	R0CNSM	180038H	14	For RBG0

• Pattern Name Control (Continued)

Special Priority (For Pattern Name Supplement Data)	N0SPR	180030H	9	For NBG0 (or RBG1)
Special Priority (For Pattern Name Supplement Data)	N1SPR	180032H	9	For NBG1
Special Priority (For Pattern Name Supplement Data)	N2SPR	180034H	9	For NBG2
Special Priority (For Pattern Name Supplement Data)	N3SPR	180036H	9	For NBG3
Special Priority (For Pattern Name Supplement Data)	R0SPR	180038H	9	For RBG0
Special Color Calculation (For Pattern Name Supplement Data)	N0SCC	180030H	8	For NBG0 (or RBG1)
Special Color Calculation (For Pattern Name Supplement Data)	N1SCC	180032H	8	For NBG1
Special Color Calculation (For Pattern Name Supplement Data)	N2SCC	180034H	8	For NBG2
Special Color Calculation (For Pattern Name Supplement Data)	N3SCC	180036H	8	For NBG3
Special Color Calculation (For Pattern Name Supplement Data)	R0SCC	180038H	8	For RBG0
Supplement Palette Number	N0SPLT	180030H	7~5	For NBG0 (or RBG1)
Supplement Palette Number	N1SPLT	180032H	7~5	For NBG1
Supplement Palette Number	N2SPLT	180034H	7~5	For NBG2
Supplement Palette Number	N3SPLT	180036H	7~5	For NBG3
Supplement Palette Number	R0SPLT	180038H	7~5	For RBG0
Supplement Character Number	N0SCN	180030H	4~0	For NBG0 (or RBG1)
Supplement Character Number	N1SCN	180032H	4~0	For NBG1
Supplement Character Number	N2SCN	180034H	4~0	For NBG2
Supplement Character Number	N3SCN	180036H	4~0	For NBG3
Supplement Character Number	R0SCN	180038H	4~0	For RBG0

• Plane Size

Plane Size	N0PLSZ	18003AH	1,0	For NBG0
Plane Size	N1PLSZ	18003AH	3,2	For NBG1
Plane Size	N2PLSZ	18003AH	5,4	For NBG2
Plane Size	N3PLSZ	18003AH	7,6	For NBG3
Plane Size	RAPLSZ	18003AH	9,8	For Rotation Parameter A
Plane Size	RBPLSZ	18003AH	13,12	For Rotation Parameter B
Screen Over Processing	RAOVR	18003AH	11,10	For Rotation Parameter A
Screen Over Processing	RBOVR	18003AH	15,14	For Rotation Parameter B

• Map Offset

Map Offset	N0MP	18003CH	2~0	For NBG0
Map Offset	N1MP	18003CH	6~4	For NBG1
Map Offset	N2MP	18003CH	10~8	For NBG2
Map Offset	N3MP	18003CH	14~12	For NBG3
Map Offset	RAMP	18003EH	2~0	For Rotation Parameter A
Map Offset	RBMP	18003EH	6~4	For Rotation Parameter B





Bit Name	Bit Abbreviation	Address	Bit	Application
• Map				
Map (For Normal Scroll)	N0MPA	180040H	5~0	For NBG0 Plane A
Map (For Normal Scroll)	N0MPB	180040H	13~8	For NBG0 Plane B
Map (For Normal Scroll)	N0MPC	180042H	5~0	For NBG0 Plane C
Map (For Normal Scroll)	N0MPD	180042H	13~8	For NBG0 Plane D
Map (For Normal Scroll)	N1MPA	180044H	5~0	For NBG1 Plane A
Map (For Normal Scroll)	N1MPB	180044H	13~8	For NBG1 Plane B
Map (For Normal Scroll)	N1MPC	180046H	5~0	For NBG1 Plane C
Map (For Normal Scroll)	N1MPD	180046H	13~8	For NBG1 Plane D
Map (For Normal Scroll)	N2MPA	180048H	5~0	For NBG2 Plane A
Map (For Normal Scroll)	N2MPB	180048H	13~8	For NBG2 Plane B
Map (For Normal Scroll)	N2MPC	18004AH	5~0	For NBG2 Plane C
Map (For Normal Scroll)	N2MPD	18004AH	13~8	For NBG2 Plane D
Map (For Normal Scroll)	N3MPA	18004CH	5~0	For NBG3 Plane A
Map (For Normal Scroll)	N3MPB	18004CH	13~8	For NBG3 Plane B
Map (For Normal Scroll)	N3MPC	18004EH	5~0	For NBG3 Plane C
Map (For Normal Scroll)	N3MPD	18004EH	13~8	For NBG3 Plane D
Map (For Rotation Scroll)	RAMPA	180050H	5~0	Rotation Parameter-A Screen Plane-A
Map (For Rotation Scroll)	RAMPB	180050H	13~8	Rotation Parameter-A Screen Plane-B
Map (For Rotation Scroll)	RAMPC	180052H	5~0	Rotation Parameter-A Screen Plane-C
Map (For Rotation Scroll)	RAMPD	180052H	13~8	Rotation Parameter-A Screen Plane-D
Map (For Rotation Scroll)	RAMPE	180054H	5~0	Rotation Parameter-A Screen Plane-E
Map (For Rotation Scroll)	RAMPF	180054H	13~8	Rotation Parameter-A Screen Plane-F
Map (For Rotation Scroll)	RAMPG	180056H	5~0	Rotation Parameter-A Screen Plane-G
Map (For Rotation Scroll)	RAMPH	180056H	13~8	Rotation Parameter-A Screen Plane-H
Map (For Rotation Scroll)	RAMPI	180058H	5~0	Rotation Parameter-A Screen Plane-I
Map (For Rotation Scroll)	RAMPJ	180058H	13~8	Rotation Parameter-A Screen Plane-J
Map (For Rotation Scroll)	RAMPK	18005AH	5~0	Rotation Parameter-A Screen Plane-K
Map (For Rotation Scroll)	RAMPL	18005AH	13~8	Rotation Parameter-A Screen Plane-L
Map (For Rotation Scroll)	RAMPM	18005CH	5~0	Rotation Parameter-A Screen Plane-M
Map (For Rotation Scroll)	RAMPN	18005CH	13~8	Rotation Parameter-A Screen Plane-N
Map (For Rotation Scroll)	RAMPO	18005EH	5~0	Rotation Parameter-A Screen Plane-O
Map (For Rotation Scroll)	RAMPP	18005EH	13~8	Rotation Parameter-A Screen Plane-P
Map (For Rotation Scroll)	RBMPA	180060H	5~0	Rotation Parameter-B Screen Plane-A
Map (For Rotation Scroll)	RBMPB	180060H	13~8	Rotation Parameter-B Screen Plane-B
Map (For Rotation Scroll)	RBMPC	180062H	5~0	Rotation Parameter-B Screen Plane-C
Map (For Rotation Scroll)	RBMPD	180062H	13~8	Rotation Parameter-B Screen Plane-D
Map (For Rotation Scroll)	RBMPE	180064H	5~0	Rotation Parameter-B Screen Plane-E
Map (For Rotation Scroll)	RBMPF	180064H	13~8	Rotation Parameter-B Screen Plane-F
Map (For Rotation Scroll)	RBMPG	180066H	5~0	Rotation Parameter-B Screen Plane-G
Map (For Rotation Scroll)	RBMPH	180066H	13~8	Rotation Parameter-B Screen Plane-H
Map (For Rotation Scroll)	RBMPI	180068H	5~0	Rotation Parameter-B Screen Plane-I
Map (For Rotation Scroll)	RBMPJ	180068H	13~8	Rotation Parameter-B Screen Plane-J

Bit Name	Bit Abbreviation	Address	Bit	Application
<b>• Map (Continued)</b>				
Map (For Rotation Scroll)	RBMPK	18006AH	5~0	Rotation Parameter-B Screen Plane-K
Map (For Rotation Scroll)	RBMPL	18006AH	13~8	Rotation Parameter-B Screen Plane-L
Map (For Rotation Scroll)	RBMPM	18006CH	5~0	Rotation Parameter-B Screen Plane-M
Map (For Rotation Scroll)	RBMPN	18006CH	13~8	Rotation Parameter-B Screen Plane-N
Map (For Rotation Scroll)	RBMPO	18006EH	5~0	Rotation Parameter-B Screen Plane-O
Map (For Rotation Scroll)	RBMPP	18006EH	13~8	Rotation Parameter-B Screen Plane-P
<b>• Screen Scroll Value</b>				
Screen Scroll Value	N0SCXI	180070H	10~0	For NBG0 Horizontal (Integer Part)
Screen Scroll Value	N0SCXD	180072H	15~8	For NBG0 Horizontal (Fractional Part)
Screen Scroll Value	N0SCYI	180074H	10~0	For NBG0 Vertical (Integer Part)
Screen Scroll Value	N0SCYD	180076H	15~8	For NBG0 Vertical (Fractional Part)
Screen Scroll Value	N1SCXI	180080H	10~0	For NBG1 Horizontal (Integer Part)
Screen Scroll Value	N1SCXD	180082H	15~8	For NBG1 Horizontal (Fractional Part)
Screen Scroll Value	N1SCYI	180084H	10~0	For NBG1 Vertical (Integer Part)
Screen Scroll Value	N1SCYD	180086H	15~8	For NBG1 Vertical (Fractional Part)
Screen Scroll Value	N2SCX	180090H	10~0	For NBG2 Horizontal
Screen Scroll Value	N2SCY	180092H	10~0	For NBG2 Vertical
Screen Scroll Value	N3SCX	180094H	10~0	For NBG3 Horizontal
Screen Scroll Value	N3SCY	180096H	10~0	For NBG3 Vertical
<b>• Coordinate Increment</b>				
Coordinate Increment	N0ZMXI	180078H	2~0	For NBG0 Horizontal (Integer Part)
Coordinate Increment	N0ZMXD	18007AH	15~8	For NBG0 Horizontal (Fractional Part)
Coordinate Increment	N0ZMYI	18007CH	2~0	For NBG0 Vertical (Integer Part)
Coordinate Increment	N0ZMYD	18007EH	15~8	For NBG0 Vertical (Fractional Part)
Coordinate Increment	N1ZMXI	180088H	2~0	For NBG1 Horizontal (Integer Part)
Coordinate Increment	N1ZMXD	18008AH	15~8	For NBG1 Horizontal (Fractional Part)
Coordinate Increment	N1ZMYI	18008CH	2~0	For NBG1 Vertical (Integer Part)
Coordinate Increment	N1ZMYD	18008EH	15~8	For NBG1 Vertical (Fractional Part)
<b>• Reduction Enable</b>				
Reduction Enable	N0ZMHF	180098H	0	For NBG0
Reduction Enable	N0ZMQT	180098H	1	For NBG0
Reduction Enable	N1ZMHF	180098H	8	For NBG1
Reduction Enable	N1ZMQT	180098H	9	For NBG1
<b>• Line &amp; Vertical Cell Scroll Control</b>				
Vertical Cell Scroll Enable	N0VCSC	18009AH	0	For NBG0
Vertical Cell Scroll Enable	N1VCSC	18009AH	8	For NBG1
Line Scroll Enable (For Horizontal Screen Scroll Values)	N0LSCX	18009AH	1	For NBG0
Line Scroll Enable (For Horizontal Screen Scroll Values)	N1LSCX	18009AH	9	For NBG1
Line Scroll Enable (For Vertical Screen Scroll Values)	N0LSCY	18009AH	2	For NBG0



Bit Name	Bit Abbreviation	Address	Bit	Application
<b>• Line &amp; Vertical Cell Scroll Control (Continued)</b>				
Line Scroll Enable (For Vertical Screen Scroll Values)	N1LSCY	18009AH	10	For NBG1
Line Zoom Enable	N0LZMX	18009AH	3	For NBG0
Line Zoom Enable	N1LZMX	18009AH	11	For NBG1
Line Scroll Space	N0LSS	18009AH	5,4	For NBG0
Line Scroll Space	N1LSS	18009AH	13,12	For NBG1
<b>• Vertical Cell Scroll Table Address</b>				
Vert. Cell Scroll Table Address	VCSTA	18009CH	2~0	
		18009EH	15~1	
<b>• Line Scroll Table Address</b>				
Line Scroll Table Address	N0LSTA	1800A0H	2~0	For NBG0 (Most Significant Bits)
		1800A2H	15~1	For NBG0 (Least Significant Bits)
Line Scroll Table Address	N1LSTA	1800A4H	2~0	For NBG1 (Most Significant Bits)
		1800A6H	15~1	For NBG1 (Least Significant Bits)
<b>• Line Color Screen Table Address</b>				
Line Color Screen Color Mode	LCCLMD	1800A8H	15	
Line Color Screen Table Add.	LCTA	1800A8H	2~0	
		1800AAH	15~0	
<b>• Back Screen Table Address</b>				
Back Screen Color Mode	BKCLMD	1800ACH	15	
Back Screen Table Address	BKTA	1800ACH	2~0	
		1800AEH	15~0	
<b>• Rotation Parameter Mode</b>				
Rotation Parameter Mode	RPMD	1800B0H	1,0	
<b>• Rotation Parameter Read Control</b>				
Parameter Read Enable	RAXSTRE	1800B2H	0	For Rotation Parameter-A Xst
Parameter Read Enable	RBXSTRE	1800B2H	8	For Rotation Parameter-B Xst
Parameter Read Enable	RAYSTRE	1800B2H	1	For Rotation Parameter-A Yst
Parameter Read Enable	RBYSTRE	1800B2H	9	For Rotation Parameter-B Yst
Parameter Read Enable	RAKASTRE	1800B2H	2	For Rotation Parameter-A KAst
Parameter Read Enable	RBKASTRE	1800B2H	10	For Rotation Parameter-B KAst
<b>• Coefficient Table Control</b>				
Coefficient Table Enable	RAKTE	1800B4H	0	For Rotation Parameter-A
Coefficient Table Enable	RBKTE	1800B4H	8	For Rotation Parameter-B
Coefficient Data Size	RAKDBS	1800B4H	1	For Rotation Parameter-A
Coefficient Data Size	RBKDBS	1800B4H	9	For Rotation Parameter-B
Coefficient Data Mode	RAKMD	1800B4H	3,2	For Rotation Parameter-A
Coefficient Data Mode	RBKMD	1800B4H	11,10	For Rotation Parameter-B
Coefficient Line Color Enable	RAKLCE	1800B4H	4	For Rotation Parameter-A
Coefficient Line Color Enable	RBKLCE	1800B4H	12	For Rotation Parameter-B

Bit Name	Bit Abbreviation	Address	Bit	Application
• Coefficient Table Address Offset				
Coefficient Table Add. Offset	RAKTAOS	1800B6H	2~0	For Rotation Parameter-A
Coefficient Table Add. Offset	RBKTAOS	1800B6H	10~8	For Rotation Parameter-B
• Screen Over Pattern Name				
Screen Over Pattern Name	RAOPN	1800B8H	15~0	For Rotation Parameter-A
Screen Over Pattern Name	RBOPN	1800BAH	15~0	For Rotation Parameter-B
• Rotation Parameter Table Address				
Rotation Parameter Table Add.	RPTA	1800BCH	2~0	
		1800BEH	15~1	
• Window Position				
Window Position (For Horizontal Coordinates)	W0SX	1800C0H	9~0	For W0 Start Point Coordinates
Window Position (For Vertical Coordinates)	W0SY	1800C2H	8~0	For W0 Start Point Coordinates
Window Position (For Horizontal Coordinates)	W0EX	1800C4H	9~0	For W0 End Point Coordinates
Window Position (For Vertical Coordinates)	W0EY	1800C6H	8~0	For W0 End Point Coordinates
Window Position (For Horizontal Coordinates)	W1SX	1800C8H	9~0	For W1 Start Point Coordinates
Window Position (For Vertical Coordinates)	W1SY	1800CAH	8~0	For W1 Start Point Coordinates
Window Position (For Horizontal Coordinates)	W1EX	1800CCH	9~0	For W1 End Point Coordinates
Window Position (For Vertical Coordinates)	W1EY	1800CEH	8~0	For W1 End Point Coordinates
• Window Control				
W0 Enable	N0W0E	1800D0H	1	For Transparent Processing Window NBG0 (or RBG1)
W0 Enable	N1W0E	1800D0H	9	For Transparent Processing Window NBG1 (or EXBG)
W0 Enable	N2W0E	1800D2H	1	For Transparent Processing Window NBG2
W0 Enable	N3W0E	1800D2H	9	For Transparent Processing Window NBG3
W0 Enable	R0W0E	1800D4H	1	For Transparent Processing Window RBG0
W0 Enable	SPW0E	1800D4H	9	For Transparent Processing Window Sprite
W0 Enable	RPW0E	1800D6H	1	For Rotation Parameter Window
W0 Enable	CCW0E	1800D6H	9	For Color Calculation Window
W0 Area	N0W0A	1800D0H	0	For Transparent Processing Window NBG0 (or RBG1)
W0 Area	N1W0A	1800D0H	8	For Transparent Processing Window NBG1 (or EXBG)
W0 Area	N2W0A	1800D2H	0	For Transparent Processing Window NBG2
W0 Area	N3W0A	1800D2H	8	For Transparent Processing Window NBG3
W0 Area	R0W0A	1800D4H	0	For Transparent Processing Window RBG0
W0 Area	SPW0A	1800D4H	8	For Transparent Processing Window Sprite
W0 Area	RPW0A	1800D6H	0	For Rotation Parameter Window
W0 Area	CCW0A	1800D6H	8	For Color Calculation Window



Bit Name	Bit Abbreviation	Address	Bit	Application
• Window Control (Continued)				
W1 Enable	N0W1E	1800D0H	3	For Transparent Processing Window NBG0 (or RBG1)
W1 Enable	N1W1E	1800D0H	11	For Transparent Processing Window NBG1 (or EXBG)
W1 Enable	N2W1E	1800D2H	3	For Transparent Processing Window NBG2
W1 Enable	N3W1E	1800D2H	11	For Transparent Processing Window NBG3
W1 Enable	R0W1E	1800D4H	3	For Transparent Processing Window RBG0
W1 Enable	SPW1E	1800D4H	11	For Transparent Processing Window Sprite
W1 Enable	RPW1E	1800D6H	3	For Rotation Parameter Window
W1 Enable	CCW1E	1800D6H	11	For Color Calculation Window
W1 Area	N0W1A	1800D0H	2	For Transparent Processing Window NBG0 (or RBG1)
W1 Area	N1W1A	1800D0H	10	For Transparent Processing Window NBG1 (or EXBG)
W1 Area	N2W1A	1800D2H	2	For Transparent Processing Window NBG2
W1 Area	N3W1A	1800D2H	10	For Transparent Processing Window NBG3
W1 Area	R0W1A	1800D4H	2	For Transparent Processing Window RBG0
W1 Area	SPW1A	1800D4H	10	For Transparent Processing Window Sprite
W1 Area	RPW1A	1800D6H	2	For Rotation Parameter Window
W1 Area	CCW1A	1800D6H	10	For Color Calculation Window
SW Enable	N0SWE	1800D0H	5	For Transparent Processing Window NBG0 (or RBG1)
SW Enable	N1SWE	1800D0H	13	For Transparent Processing Window NBG1 (or EXBG)
SW Enable	N2SWE	1800D2H	5	For Transparent Processing Window NBG2
SW Enable	N3SWE	1800D2H	13	For Transparent Processing Window NBG3
SW Enable	R0SWE	1800D4H	5	For Transparent Processing Window RBG0
SW Enable	SPSWE	1800D4H	13	For Transparent Processing Window Sprite
SW Enable	CCSWE	1800D6H	13	For Color Calculation Window
SW Area	N0SWA	1800D0H	4	For Transparent Processing Window NBG0 (or RBG1)
SW Area	N1SWA	1800D0H	12	For Transparent Processing Window NBG1 (or EXBG)
SW Area	N2SWA	1800D2H	4	For Transparent Processing Window NBG2
SW Area	N3SWA	1800D2H	12	For Transparent Processing Window NBG3
SW Area	R0SWA	1800D4H	4	For Transparent Processing Window RBG0
SW Area	SPSWA	1800D4H	12	For Transparent Processing Window Sprite
SW Area	CCSWA	1800D6H	12	For Color Calculation Window
Window Logic	N0LOG	1800D0H	7	For Transparent Processing Window NBG0 (or RBG1)
Window Logic	N1LOG	1800D0H	15	For Transparent Processing Window NBG1 (or EXBG)
Window Logic	N2LOG	1800D2H	7	For Transparent Processing Window NBG2
Window Logic	N3LOG	1800D2H	15	For Transparent Processing Window NBG3
Window Logic	R0LOG	1800D4H	7	For Transparent Processing Window RBG0
Window Logic	SPLOG	1800D4H	15	For Transparent Processing Window Sprite

Bit Name	Bit Abbreviation	Address	Bit	Application
<b>• Window Control (Continued)</b>				
Window Logic	RPLOG	1800D6H	7	For Rotation Parameter Window
Window Logic	CCLOG	1800D6H	15	For Color Calculation Window
<b>• Line Window Table Address</b>				
Line Window Enable	W0LWE	1800D8H	15	For W0
Line Window Enable	W1LWE	1800DCH	15	For W1
Line Window Table Address	W0LWTA	1800D8H	2~0	For W0
		1800DAH	15~1	For W0
Line Window Table Address	W1LWTA	1800DCH	2~0	For W1
		1800DEH	15~1	For W1
<b>• Sprite Control</b>				
Sprite Type	SPTYPE	1800E0H	3~0	
Sprite Window Enable	SPWINEN	1800E0H	4	
Sprite Color Mode	SPCLMD	1800E0H	5	
Sprite Color Calculation Condition	SPCCCS	1800E0H	13,12	
Sprite Color Calculation Number	SPCCN	1800E0H	10~8	
<b>• Shadow Control</b>				
Transparent Shadow Select	TPSDSL	1800E2H	8	
Shadow Enable	N0SDEN	1800E2H	0	For NBG0 (or RBG1)
Shadow Enable	N1SDEN	1800E2H	1	For NBG1 (or EXBG)
Shadow Enable	N2SDEN	1800E2H	2	For NBG2
Shadow Enable	N3SDEN	1800E2H	3	For NBG3
Shadow Enable	R0SDEN	1800E2H	4	For RBG0
Shadow Enable	BKSDEN	1800E2H	5	For Back
<b>• Color RAM Address Offset</b>				
Color RAM Address Offset	N0CAOS	1800E4H	2~0	For NBG0 (or RBG1)
Color RAM Address Offset	N1CAOS	1800E4H	6~4	For NBG1 (or EXBG)
Color RAM Address Offset	N2CAOS	1800E4H	10~8	For NBG2
Color RAM Address Offset	N3CAOS	1800E4H	14~12	For NBG3
Color RAM Address Offset	R0CAOS	1800E6H	2~0	For RBG0
Color RAM Address Offset	SPCAOS	1800E6H	6~4	For Sprite
<b>• Line Color Screen Enable</b>				
Line Color Screen Insertion Enable	N0LCEN	1800F8H	0	For NBG0 (or RBG1)
Line Color Screen Insertion Enable	N1LCEN	1800F8H	1	For NBG1 (or EXBG)
Line Color Screen Insertion Enable	N2LCEN	1800F8H	2	For NBG2
Line Color Screen Insertion Enable	N3LCEN	1800F8H	3	For NBG3
Line Color Screen Insertion Enable	R0LCEN	1800F8H	4	For RBG0
Line Color Screen Insertion Enable	SPLCEN	1800F8H	5	For Sprite



Bit Name	Bit Abbreviation	Address	Bit	Application
• Special Priority Mode				
Special Priority Mode	N0SPRM	1800EAH	1,0	For NBG0 (or RBG1)
Special Priority Mode	N1SPRM	1800EAH	3,2	For NBG1 (or EXBG)
Special Priority Mode	N2SPRM	1800EAH	5,4	For NBG2
Special Priority Mode	N3SPRM	1800EAH	7,6	For NBG3
Special Priority Mode	R0SPRM	1800EAH	9,8	For RBG0
• Color Calculation Control				
Color Calculation Enable	N0CCEN	1800ECH	0	For NBG0 (or RBG1)
Color Calculation Enable	N1CCEN	1800ECH	1	For NBG1 (or EXBG)
Color Calculation Enable	N2CCEN	1800ECH	2	For NBG2
Color Calculation Enable	N3CCEN	1800ECH	3	For NBG3
Color Calculation Enable	R0CCEN	1800ECH	4	For RBG0
Color Calculation Enable	LCCEN	1800ECH	5	For LNCL
Color Calculation Enable	SPCCEN	1800ECH	6	For Sprite
Color Calculation Mode	CCMD	1800ECH	8	
Color Calculation Ratio Mode	CCRTMD	1800ECH	9	
Extended Color Calculation Enable	EXCCEN	1800ECH	10	
Gradation Calculation Enable	BOKEN	1800ECH	15	
Gradation Screen Number	BOKN	1800ECH	14~12	
• Special Color Calculation Mode				
Special Color Calculation Mode	N0SCCM	1800EEH	1,0	For NBG0 (or RBG1)
Special Color Calculation Mode	N1SCCM	1800EEH	3,2	For NBG1 (or EXBG)
Special Color Calculation Mode	N2SCCM	1800EEH	5,4	For NBG2
Special Color Calculation Mode	N3SCCM	1800EEH	7,6	For NBG3
Special Color Calculation Mode	R0SCCM	1800EEH	9,8	For RBG0
• Priority Number				
Priority Number (for Sprite)	S0PRIN	1800F0H	2~0	For Sprite Register 0
Priority Number (for Sprite)	S1PRIN	1800F0H	10~8	For Sprite Register 1
Priority Number (for Sprite)	S2PRIN	1800F2H	2~0	For Sprite Register 2
Priority Number (for Sprite)	S3PRIN	1800F2H	10~8	For Sprite Register 3
Priority Number (for Sprite)	S4PRIN	1800F4H	2~0	For Sprite Register 4
Priority Number (for Sprite)	S5PRIN	1800F4H	10~8	For Sprite Register 5
Priority Number (for Sprite)	S6PRIN	1800F6H	2~0	For Sprite Register 6
Priority Number (for Sprite)	S7PRIN	1800F6H	10~8	For Sprite Register 7

Bit Name	Bit Abbreviation	Address	Bit	Application
----------	------------------	---------	-----	-------------

• Priority Number (Continued)

Priority Number (for Scroll Screen)	N0PRIN	1800F8H	2~0	For NBG0 (or RBG1)
Priority Number for (for Scroll Screen)	N1PRIN	1800F8H	10~8	For NBG1 (or EXBG)
Priority Number for (for Scroll Screen)	N2PRIN	1800FAH	2~0	For NBG2
Priority Number for (for Scroll Screen)	N3PRIN	1800FAH	10~8	For NBG3
Priority Number for (for Scroll Screen)	R0PRIN	1800FCH	2~0	For RBG0

• Color Calculation Ratio

Color Calculation Ratio (For Sprite)	S0CCRT	180100H	4~0	For Sprite Register 0
Color Calculation Ratio (For Sprite)	S1CCRT	180100H	12~8	For Sprite Register 1
Color Calculation Ratio (For Sprite)	S2CCRT	180102H	4~0	For Sprite Register 2
Color Calculation Ratio (For Sprite)	S3CCRT	180102H	12~8	For Sprite Register 3
Color Calculation Ratio (For Sprite)	S4CCRT	180104H	4~0	For Sprite Register 4
Color Calculation Ratio (For Sprite)	S5CCRT	180104H	12~8	For Sprite Register 5
Color Calculation Ratio (For Sprite)	S6CCRT	180106H	4~0	For Sprite Register 6
Color Calculation Ratio (For Sprite)	S7CCRT	180106H	12~8	For Sprite Register 7
Color Calculation Ratio (For Scroll Screen)	N0CCRT	180108H	4~0	For NBG0 (or RBG1)
Color Calculation Ratio (For Scroll Screen)	N1CCRT	180108H	12~8	For NBG1 (or EXBG)
Color Calculation Ratio (For Scroll Screen)	N2CCRT	18010AH	4~0	For NBG2
Color Calculation Ratio (For Scroll Screen)	N3CCRT	18010AH	12~8	For NBG3
Color Calculation Ratio (For Scroll Screen)	R0CCRT	18010CH	4~0	For RBG0
Color Calculation Ratio (For Scroll Screen)	LCCRT	18010EH	4~0	For LNCL
Color Calculation Ratio (For Scroll Screen)	BKCCRT	18010EH	12~8	For BACK

• Color Offset Enable

Color Offset Enable	N0COEN	180110H	0	For NBG0 (or RBG1)
Color Offset Enable	N1COEN	180110H	1	For NBG1 (or EXBG)
Color Offset Enable	N2COEN	180110H	2	For NBG2
Color Offset Enable	N3COEN	180110H	3	For NBG3
Color Offset Enable	R0COEN	180110H	4	For RBG0
Color Offset Enable	BKCOEN	180110H	5	For BACK
Color Offset Enable	SPCOEN	180110H	6	For Sprite

• Color Offset Select

Color Offset Select	N0COSL	180112H	0	For NBG0 (or RBG1)
Color Offset Select	N1COSL	180112H	1	For NBG1 (or EXBG)
Color Offset Select	N2COSL	180112H	2	For NBG2
Color Offset Select	N3COSL	180112H	3	For NBG3
Color Offset Select	R0COSL	180112H	4	For RBG0
Color Offset Select	BKCOSL	180112H	5	For BACK
Color Offset Select	SPCOSL	180112H	6	For Sprite

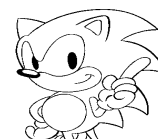



Bit Name	Bit Abbreviation	Address	Bit	Application
• Color Offset				
Color Offset Value	COARD	180114H	8~0	For Color Offset A Red Data
Color Offset Value	COAGR	180116H	8~0	For Color Offset A Green Data
Color Offset Value	COABL	180118H	8~0	For Color Offset A Blue Data
Color Offset Value	COBRD	18011AH	8~0	For Color Offset B Red Data
Color Offset Value	COBGR	18011CH	8~0	For Color Offset B Green Data
Color Offset Value	COBBL	18011EH	8~0	For Color Offset B Blue Data

SEGA Confidential

## 16.3 Register Bit Functions

### • TV Mode (Read Allowed)

	15	14	13	12	11	10	9	8
TVMD	DISP	~	~	~	~	~	~	BDCLMD
180000H	7	6	5	4	3	2	1	0
	LSMD1	LSMD0	VRESO1	VRESO0	~	HRESO2	HRESO1	HRESO0

**TV screen display bit : Display bit (DISP), bit 15**  
Controls picture display to the TV screen.

DISP	Process
0	Picture is not displayed on TV screen
1	Picture is displayed on TV screen

**Border color mode bit (BDCLMD), bit 8**  
Controls colors displayed by the border area.

BDCLMD	Process
0	Displays black
1	Display back screen

**Interlace mode bit (LSMD1, LSMD0) bits 7 and 6**  
Designates the interlace mode.

LSMD1	LSMD0	Process
0	0	Non-Interlace
0	1	Setting not allowed
1	0	Single-density interlace
1	1	Double-density interlace

**Vertical resolution bit (VRESO1, VRESO0), bit 5, 4**  
Designates vertical resolution when a picture is displayed on the TV screen.

VRESO1	VRESO0	Vertical Resolution	Display Monitor
0	0	224 Lines	NTSC or PAL format TV
0	1	240 Lines	NTSC or PAL format TV
1	0	256 Lines	PAL format TV
1	1	Not Allowed	-



**Horizontal resolution bit (HRESO2 to HRESO0), bit 2 to 0**

Selects the horizontal resolution when a picture is displayed on the TV screen.

HRESO2	HRESO1	HRESO0	Horizontal Resolution	Graphic Mode	Display Monitor
0	0	0	320 Pixels	Normal Graphic A	NTSC Format or PAL Format TV
0	0	1	352 Pixels	Normal Graphic B	
0	1	0	640 Pixels	Hi-Res Graphic A	
0	1	1	704 Pixels	Hi-Res Graphic B	
1	0	0	320 Pixels	Exclusive Normal Graphic A	31kHz Monitor
1	0	1	352 Pixels	Exclusive Normal Graphic B	Hi-Vision Monitor
1	1	0	640 Pixels	Exclusive Normal Graphic A	31kHz Monitor
1	1	1	704 Pixels	Exclusive Normal Graphic B	Hi-Vision Monitor

• **External Signal Enable Register (Read Allowed)**

	15	14	13	12	11	10	9	8
EXTEN	~	~	~	~	~	~	EXLTEN	EXSYEN
180002H	7	6	5	4	3	2	1	0
	~	~	~	~	~	~	DASEL	EXBGEN

**External latch enable bit (EXLTEN), bit 9**

Selects the condition for latching the HV counter value to the HV counter register.

EXLTEN	Condition
0	Latches when reading external signal enable register
1	Latches through external signal

**EXSYNC enable bit (EXSYEN), bit 8**

Controls input to the internal synchronous circuit of the external sync signal.

EXSYEN	Process
0	Does not input external sync signal
1	Inputs external sync signal, and synchronizes TV screen display with the external

**Display area select bit (DASEL), bit1**

Designates the image display area. Valid only when the EXBGEN bit is 1.

DASEL	Process
0	Displays screen image only in the set display area
1	Displays screen in the standard display area

**EXBG enable bit (EXBGEN), bit 0**

Controls input of external screen data.

EXBGEN	Process
0	Does not input external screen data
1	Inputs external screen data

**• Screen Status (Read Only)**

	15	14	13	12	11	10	9	8
TVSTAT	~	~	~	~	~	~	EXLTFG	EXSYFG
180004H	7	6	5	4	3	2	1	0
	~	~	~	~	VBLANK	HBLANK	ODD	PAL

**External latch flag (EXLTFG), bit 9**

Through external signals, this displays whether the HV counter value is latched to the HV counter register. Clears to 0 when the screen status register reads out.

EXLTFG	HV Counter Value Status
0	Not latched in register
1	Latched in register

**External SYNC flag (EXSYFG), bit 8**

Displays whether the internal routes through External SYNC flag are in sync. Clears to 0 when the screen status register reads out.

EXSYFG	External Sync Status
0	Not synchronized
1	Internal circuit synchronized



**Vertical blank flag (VBLANK), bit 3**

Displays the vertical scan status of the TV screen.

VBLANK	Vertical Scan Status
0	During vertical scan
1	During vertical re-trace (VBLANK)

**Horizontal blank flag (HBLANK), bit 2**

Displays the horizontal scan status of the TV screen.

HBLANK	Horizontal Scan Status
0	During horizontal scan
1	During horizontal re-trace (HBLANK)

**Scan Field Flag : Odd/even field flag (ODD), bit 1**

Scan conditions are shown when the TV screen mode is the interlace mode. The non-interlace mode is always 1.

ODD	Display
0	During even field scan
1	During odd field scan

**TV standard flags : PAL/NTSC flag (PAL), bit 0**

Displays TV standards.

PAL	Display
0	NTSC standard
1	PAL standard

**• VRAM Size (Read Allowed)**

	15	14	13	12	11	10	9	8
VRSIZE	VRAMSZ	~	~	~	~	~	~	~
180006H	7	6	5	4	3	2	1	0
	~	~	~	~	VER3	VER2	VER1	VER0

**VRAM size bit (VRAMSZ), bit 15.**

Indicates the VRAM capacity used in the system.

VRAMSZ	VRAM Size
0	4M bit
1	8M bit

**Version Number Bit (VER3 to VER0), Bits 3 to 0**

Shows the VDP2 version number; the first is 0.

**• H Counter (Read Only)**

	15	14	13	12	11	10	9	8
HCNT	~	~	~	~	~	~	HCT9	HCT8
180008H	7	6	5	4	3	2	1	0
	HCT7	HCT6	HCT5	HCT4	HCT3	HCT2	HCT1	HCT0

**H counter bit (HCT9 to HCT0), bits 9 to 0**

Signals controlled through EXLTEN external signal enable register show the latched H counter values.

Graphic Mode	HCT9	HCT8	HCT7	HCT6	HCT5	HCT4	HCT3	HCT2	HCT1	HCT0
Normal	H8	H7	H6	H5	H4	H3	H2	H1	H0	Invalid
Hi-Res	H9	H8	H7	H6	H5	H4	H3	H2	H1	H0
Exclusive Normal	Invalid	H8	H7	H6	H5	H4	H3	H2	H1	H0
Exclusive Hi-Res	Invalid	H9	H8	H7	H6	H5	H4	H3	H2	H1

**• V Counter (Read Only)**

	15	14	13	12	11	10	9	8
VCNT	~	~	~	~	~	~	VCT9	VCT8
18000AH	7	6	5	4	3	2	1	0
	VCT7	VCT6	VCT5	VCT4	VCT3	VCT2	VCT1	VCT0



**V counter value bit : V counter bit (VCT9~VCT0), bit 9 to 0**

Signals controlled through EXLTEN external signal enable register show the latched V counter values.

TV Screen (Interlace) Mode	VCT9	VCT8	VCT7	VCT6	VCT5	VCT4	VCT3	VCT2	VCT1	VCT0
Normal Hi-Res (Non-Interlace, Single-Density Interlace)	V8	V7	V6	V5	V4	V3	V2	V1	V0	Invalid
Normal Hi-Res (Double-Density Interlace)	V8	V7	V6	V5	V4	V3	V2	V1	V0	0: Odd fields 1: Even fields
Exclusive Monitor	V9	V8	V7	V6	V5	V4	V3	V2	V1	V0

**• RAM Control (Read Allowed)**

	15	14	13	12	11	10	9	8
RAMCTL	CRKTE	~	CRMD1	CRMD0	~	~	VRBMD	VRAMD
18000EH	7	6	5	4	3	2	1	0
	RDBSB11	RDBSB10	RDBSB01	RDBSB00	RDBSA11	RDBSA10	RDBSA01	RDBSA00

**Color RAM coefficient table enable bit (CRKTE), bit 15**

Designates whether to store the coefficient table in color RAM.

CRKTE	Process
0	Coefficient table is stored in VRAM.
1	Coefficient table is stored in color RAM.

**Color RAM mode bit (CRMD1, CRMD0), bits 13 and 12**

Selects the color RAM mode

CRMD1	CRMD0	Mode	Process
0	0	0	RGB each 5 bits, 1024 color settings
0	1	1	RGB each 5 bits, 2048 color settings
1	0	2	RGB each 8 bits, 1024 color settings
1	1	-	Setting not allowed

**VRAM Mode Bit (VRBMD, VRAMD), Bits 9 and 8**

Controls VRAM bank partitions

VRAMD	18000EH	Bit 8	For VRAM-A
VRBMD	18000EH	Bit 9	For VRAM-B

<b>VRxMD</b>	<b>Process</b>
0	Do not partition in 2 banks
1	Partition in 2 banks

**Note:** Enter A or B into bit name for x.

**Rotation data bank select bit: Data bank select bit (RDBSA01, RDBSA00, RDBSA11, RDBSA10, RDBSB01, RDBSB00, RDBSB11, RDBSB10)**

Designates the use objective of the VRAM of the rotation scroll screen. This bit is only in effect when the rotation scroll screen is displayed.

RDBSA00, RDBSA01	18000EH	Bit 1,0	For VRAM-A0 (or VRAM-A)
RDBSA10, RDBSA11	18000EH	Bit 3,2	For VRAM-A1
RDBSB00, RDBSB01	18000EH	Bit 5,4	For VRAM-B0 (or VRAM-B)
RDBSB10, RDBSB11	18000EH	Bit 7,6	For VRAM-B1

RDBSx1	RDBSx0	VRAM Use
0	0	Not used as RAM for RBG0
0	1	RAM for RBG0 End table
1	0	RAM for RBG0 Pattern Name table
1	1	RAM for RBG0 Character Pattern table (or Bitmap Pattern)

**Note:** A0, A1, B0, or B1 is entered in bit name for x.

#### • VRAM Cycle Pattern (Bank A0)

	15	14	13	12	11	10	9	8
CYCA0L	VCP0A03	VCP0A02	VCP0A01	VCP0A00	VCP1A03	VCP1A02	VCP1A01	VCP1A00
180010H	7	6	5	4	3	2	1	0
	VCP2A03	VCP2A02	VCP2A01	VCP2A00	VCP3A03	VCP3A02	VCP3A01	VCP3A00

#### VRAM Cycle Pattern (Bank A0)

	15	14	13	12	11	10	9	8
CYCA0U	VCP4A03	VCP4A02	VCP4A01	VCP4A00	VCP5A03	VCP5A02	VCP5A01	VCP5A00
180012H	7	6	5	4	3	2	1	0
	VCP6A03	VCP6A02	VCP6A01	VCP6A00	VCP7A03	VCP7A02	VCP7A01	VCP7A00

**VRAM cycle pattern (for VRAM-A0) bit: VRAM cycle pattern bit (VCP0A00 to VCP0A03, VCP1A00 to VCP1A03, VCP2A00 to VCP2A03, VCP3A00 to VCP3A03, VCP4A00 to VCP4A03, VCP5A00 to VCP5A03, VCP6A00 to VCP6A03, VCP7A00 to VCP7A03)**





Sets the access command of VRAM access that performs in VRAM-A0 (or VRAM-A) timing T0 to T7.

VCP0A00~VCP0A03	180010H	Bit 12~15	VRAM-A0 (or VRAM-A) Timing for T0
VCP1A00~VCP1A03	180010H	Bit 8~11	VRAM-A0 (or VRAM-A) Timing for T1
VCP2A00~VCP2A03	180010H	Bit 4~7	VRAM-A0 (or VRAM-A) Timing for T2
VCP3A00~VCP3A03	180010H	Bit 0~3	VRAM-A0 (or VRAM-A) Timing for T3
VCP4A00~VCP4A03	180012H	Bit 12~15	VRAM-A0 (or VRAM-A) Timing for T4
VCP5A00~VCP5A03	180012H	Bit 8~11	VRAM-A0 (or VRAM-A) Timing for T5
VCP6A00~VCP6A03	180012H	Bit 4~7	VRAM-A0 (or VRAM-A) Timing for T6
VCP7A00~VCP7A03	180012H	Bit 0~3	VRAM-A0 (or VRAM-A) Timing for T7

• **VRAM Cycle Pattern (Bank A1)**

	15	14	13	12	11	10	9	8
CYCA1L	VCP0A13	VCP0A12	VCP0A11	VCP0A10	VCP1A13	VCP1A12	VCP1A11	VCP1A10
180014H	7	6	5	4	3	2	1	0
	VCP2A13	VCP2A12	VCP2A11	VCP2A10	VCP3A13	VCP3A12	VCP3A11	VCP3A10

• **VRAM Cycle Pattern (Bank A1)**

	15	14	13	12	11	10	9	8
CYCA1U	VCP4A13	VCP4A12	VCP4A11	VCP4A10	VCP5A13	VCP5A12	VCP5A11	VCP5A10
180016H	7	6	5	4	3	2	1	0
	VCP6A13	VCP6A12	VCP6A11	VCP6A10	VCP7A13	VCP7A12	VCP7A11	VCP7A10

**VRAM cycle pattern (for VRAM-A1) bit: VRAM cycle pattern bit (VCP0A10 to VCP0A13, VCP1A10 to VCP1A13, VCP2A10 to VCP2A13, VCP3A10 to VCP3A13, VCP4A10 to VCP4A13, VCP5A10 to VCP5A13, VCP6A10 to VCP6A13, VCP7A10 to VCP7A13)**

Sets the access command of the VRAM access that performs in VRAM-A1 timing T0 to T7.

VCP0A10~VCP0A13	180014H	Bit 12~15	VRAM-A1 Timing for T0
VCP1A10~VCP1A13	180014H	Bit 8~11	VRAM-A1 Timing for T1
VCP2A10~VCP2A13	180014H	Bit 4~7	VRAM-A1 Timing for T2
VCP3A10~VCP3A13	180014H	Bit 0~3	VRAM-A1 Timing for T3
VCP4A10~VCP4A13	180016H	Bit 12~15	VRAM-A1 Timing for T4
VCP5A10~VCP5A13	180016H	Bit 8~11	VRAM-A1 Timing for T5
VCP6A10~VCP6A13	180016H	Bit 4~7	VRAM-A1 Timing for T6
VCP7A10~VCP7A13	180016H	Bit 0~3	VRAM-A1 Timing for T7

• **VRAM Cycle Pattern (Bank B0)**

	15	14	13	12	11	10	9	8
CYCB0L	VCP0B03	VCP0B02	VCP0B01	VCP0B00	VCP1B03	VCP1B02	VCP1B01	VCP1B00
180018H	7	6	5	4	3	2	1	0
	VCP2B03	VCP2B02	VCP2B01	VCP2B00	VCP3B03	VCP3B02	VCP3B01	VCP3B00

• **VRAM Cycle Pattern (Bank B0)**

	15	14	13	12	11	10	9	8
CYCB0U	VCP4B03	VCP4B02	VCP4B01	VCP4B00	VCP5B03	VCP5B02	VCP5B01	VCP5B00
18001AH	7	6	5	4	3	2	1	0
	VCP6B03	VCP6B02	VCP6B01	VCP6B00	VCP7B03	VCP7B02	VCP7B01	VCP7B00

**VRAM cycle pattern (for VRAM-B0) bit: VRAM cycle pattern bit (VCP0B00 to VCP0B03, VCP1B00 to VCP1B03, VCP2B00 to VCP2B03, VCP3B00 to VCP3B03, VCP4B00 to VCP4B03, VCP5B00 to VCP5B03, VCP6B00 to VCP6B03, VCP7B00 to VCP7B03)**

Sets the access command of VRAM access that performs in VRAM-B0 (or VRAM-B) timing T0 to T7.

VCP0B00~VCP0B03	180018H	Bit 12~15	VRAM-B0 (or VRAM-B) Timing for T0
VCP1B00~VCP1B03	180018H	Bit 8~11	VRAM-B0 (or VRAM-B) Timing for T1
VCP2B00~VCP2B03	180018H	Bit 4~7	VRAM-B0 (or VRAM-B) Timing for T2
VCP3B00~VCP3B03	180018H	Bit 0~3	VRAM-B0 (or VRAM-B) Timing for T3
VCP4B00~VCP4B03	18001AH	Bit 12~15	VRAM-B0 (or VRAM-B) Timing for T4
VCP5B00~VCP5B03	18001AH	Bit 8~11	VRAM-B0 (or VRAM-B) Timing for T5
VCP6B00~VCP6B03	18001AH	Bit 4~7	VRAM-B0 (or VRAM-B) Timing for T6
VCP7B00~VCP7B03	18001AH	Bit 0~3	VRAM-B0 (or VRAM-B) Timing for T7

• **VRAM Cycle Pattern (Bank B1)**

	15	14	13	12	11	10	9	8
CYCB1L	VCP0B13	VCP0B12	VCP0B11	VCP0B10	VCP1B13	VCP1B12	VCP1B11	VCP1B10
18001CH	7	6	5	4	3	2	1	0
	VCP2B13	VCP2B12	VCP2B11	VCP2B10	VCP3B13	VCP3B12	VCP3B11	VCP3B10

• **VRAM Cycle Pattern (Bank B1)**

	15	14	13	12	11	10	9	8
CYCB1U	VCP4B13	VCP4B12	VCP4B11	VCP4B10	VCP5B13	VCP5B12	VCP5B11	VCP5B10
18001EH	7	6	5	4	3	2	1	0
	VCP6B13	VCP6B12	VCP6B11	VCP6B10	VCP7B13	VCP7B12	VCP7B11	VCP7B10



VRAM cycle pattern (for VRAM-B1) bit: VRAM cycle pattern bit  
(VCP0B10 to VCP0B13, VCP1B10 to VCP1B13, VCP2B10 to VCP2B13, VCP3B10 to  
VCP3B13, VCP4B10 to VCP4B13, VCP5B10 to VCP5B13, VCP6B10 to VCP6B13,  
VCP7B10 to VCP7B13).

Sets the access command of VRAM access that performs in VRAM-B1 timing T0 to T7.

VCP0B10~VCP0B13	18001CH	Bit 12~15	VRAM-B1 Timing for T0
VCP1B10~VCP1B13	18001CH	Bit 8~11	VRAM-B1 Timing for T1
VCP2B10~VCP2B13	18001CH	Bit 4~7	VRAM-B1 Timing for T2
VCP3B10~VCP3B13	18001CH	Bit 0~3	VRAM-B1 Timing for T3
VCP4B10~VCP4B13	18001EH	Bit 12~15	VRAM-B1 Timing for T4
VCP5B10~VCP5B13	18001EH	Bit 8~11	VRAM-B1 Timing for T5
VCP6B10~VCP6B13	18001EH	Bit 4~7	VRAM-B1 Timing for T6
VCP7B10~VCP7B13	18001EH	Bit 0~3	VRAM-B1 Timing for T7

Access Command Value				VRAM Access
VCPnxx3	VCPnxx2	VCPnxx1	VCPnxx0	
0	0	0	0	NBG0 Pattern Name Data Read
0	0	0	1	NBG1 Pattern Name Data Read
0	0	1	0	NBG2 Pattern Name Data Read
0	0	1	1	NBG3 Pattern Name Data Read
0	1	0	0	NBG0 Character Pattern Data Read
0	1	0	1	NBG1 Character Pattern Data Read
0	1	1	0	NBG2 Character Pattern Data Read
0	1	1	1	NBG3 Character Pattern Data Read
1	0	0	0	Setting not allowed
1	0	0	1	Setting not allowed
1	0	1	0	Setting not allowed
1	0	1	1	Setting not allowed
1	1	0	0	NBG0 Vertical Cell Scroll Table Data Read
1	1	0	1	NBG1 Vertical Cell Scroll Table Data Read
1	1	1	0	CPU Read/Write
1	1	1	1	No Access

**Note:** n: 0 to 7 (corresponds to access timing T0 to T7)

xx: A0, A1, B0, B1 (corresponds to VRAM-A0, VRAM-A1, VRAM-B0, VRAM-B1)

## • Screen Display Enable

	15	14	13	12	11	10	9	8
BGON	~	~	~	R0TPON	N3TPON	N2TPON	N1TPON	N0TPON
180020H	7	6	5	4	3	2	1	0
	~	~	R1ON	R0ON	N3ON	N2ON	N1ON	N0ON

### Transparent display enable bit (N0TPON, N1TPON, N2TPON, N3TPON, R0TPON)

Designates whether to nullify the transparency code.

N0TPON	180020H	Bit 8	For NBG0 (or RBG1)
N1TPON	180020H	Bit 9	For NBG1 (or EXBG)
N2TPON	180020H	Bit 10	For NBG2
N3TPON	180020H	Bit 11	For NBG3
R0TPON	180020H	Bit 12	For RBG0

xxTPON	Process
0	Validates transparency code (transparency code dots become transparent)
1	Invalidates transparency code (transparency code dots are displayed according to data values)

**Note:** N0, N1, N2, N3, or R0 is entered into bit name for xx.

### Screen display enable bit: On bit (N0ON, N1ON, N2ON, N3ON, R0ON, R1ON)

Designates whether to display each scroll screen.

N0ON	180020H	Bit 0	For NBG0
N1ON	180020H	Bit 1	For NBG1
N2ON	180020H	Bit 2	For NBG2
N3ON	180020H	Bit 3	For NBG3
R0ON	180020H	Bit 4	For RBG0
R1ON	180020H	Bit 5	For RBG1

xxON	Process
0	Cannot display (Does not execute VRAM access for display)
1	Can display

**Note:** N0, N1, N2, N3, R0, or R1 is entered into bit name xx.

## • Mosaic Control

	15	14	13	12	11	10	9	8
MZCTL	MZSZV3	MZSZV2	MZSZV1	MZSZV0	MZSZH3	MZSZH2	MZSZH1	MZSZH0
180022H	7	6	5	4	3	2	1	0
	~	~	~	R0MZE	N3MZE	N2MZE	N1MZE	N0MZE



**Mosaic size bit (MZSZH3 to MZSZH0, MZSZV3 to MZSZV0)**  
Designates the horizontal and vertical mosaic size.

MZSZV3~MZSZV0	180022H	Bit 15~12	For vertical mosaic size
MZSZH3~MZSZH0	180022H	Bit 11~8	For horizontal mosaic size

MZSZH3	MZSZH2	MZSZH1	MZSZH0	Horizontal Mosaic Size
0	0	0	0	1 dot
0	0	0	1	2 dots
0	0	1	0	3 dots
0	0	1	1	4 dots
0	1	0	0	5 dots
0	1	0	1	6 dots
0	1	1	0	7 dots
0	1	1	1	8 dots
1	0	0	0	9 dots
1	0	0	1	10 dots
1	0	1	0	11 dots
1	0	1	1	12 dots
1	1	0	0	13 dots
1	1	0	1	14 dots
1	1	1	0	15 dots
1	1	1	1	16 dots

**Note:** There is no relationship with the interlace setting.

MZSZV3	MZSZV2	MZSZV1	MZSZV0	Vertical Mosaic Size	
				Non-Interlace	Interlace
0	0	0	0	1 dot	2 dots
0	0	0	1	2 dots	4 dots
0	0	1	0	3 dots	6 dots
0	0	1	1	4 dots	8 dots
0	1	0	0	5 dots	10 dots
0	1	0	1	6 dots	12 dots
0	1	1	0	7 dots	14 dots
0	1	1	1	8 dots	16 dots
1	0	0	0	9 dots	18 dots
1	0	0	1	10 dots	20 dots
1	0	1	0	11 dots	22 dots
1	0	1	1	12 dots	24 dots
1	1	0	0	13 dots	26 dots
1	1	0	1	14 dots	28 dots
1	1	1	0	15 dots	30 dots
1	1	1	1	16 dots	32 dots

**Mosaic enable bit (N0MZE, N1MZE, N2MZE, N3MZE, R0MZE)**  
Designates the screen performing mosaic process.

N0MZE	180022H	Bit 0	For NBG0 (or RBG1)
N1MZE	180022H	Bit 1	For NBG1
N2MZE	180022H	Bit 2	For NBG2
N3MZE	180022H	Bit 3	For NBG3
R0MZE	180022H	Bit 4	For RBG0

xxMZE	Process
0	Does not execute mosaic process
1	Processes mosaic process

**Note:** N0, N1, N2, N3, or R0 is entered in bit name for xx.

• **Special Function Code Select**

	15	14	13	12	11	10	9	8
SFSEL	~	~	~	~	~	~	~	~
180024H	7	6	5	4	3	2	1	0
	~	~	~	R0SFCS	N3SFCS	N2SFCS	N1SFCS	N0SFCS

**Special function code select bit (N0SFCS, N1SFCS, N2SFCS, N3SFCS, R0SFCS)**  
Designates the special function code effecting every scroll screen.

N0SFCS	180024H	Bit 0	For NBG0 (or RBG1)
N1SFCS	180024H	Bit 1	For NBG1
N2SFCS	180024H	Bit 2	For NBG2
N3SFCS	180024H	Bit 3	For NBG3
R0SFCS	180024H	Bit 4	For RBG0

xxSFCS	Process
0	Enables special function code A
1	Enables special function code B

**Note:** N0, N1, N2, N3, or R0 is entered in bit name for xx.



• **Special Function Code**

	15	14	13	12	11	10	9	8
SFCODE	SFCDB7	SFCDB6	SFCDB5	SFCDB4	SFCDB3	SFCDB2	SFCDB1	SFCDB0
180026H	7	6	5	4	3	2	1	0
	SFCDA7	SFCDA6	SFCDA5	SFCDA4	SFCDA3	SFCDA2	SFCDA1	SFCDA0

**Special function code bit (SFCDA7 to SFCDA0, SFCDB7 to SFCDB0)**  
Designates special function codes A and B.

SFCDA7~SFCDA0	180026H	Bit 7~0	For Special Function Code A
SFCDB7~SFCDB0	180026H	Bit 15~8	For Special Function Code B

Bit Name	Dot Color Code
SFC Dx0	When lower 4 bits of dot color code are, 0H or 1H
SFC Dx1	When lower 4 bits of dot color code are, 2H or 3H
SFC Dx2	When lower 4 bits of dot color code are, 4H or 5H
SFC Dx3	When lower 4 bits of dot color code are, 6H or 7H
SFC Dx4	When lower 4 bits of dot color code are, 8H or 9H
SFC Dx5	When lower 4 bits of dot color code are, AH or BH
SFC Dx6	When lower 4 bits of dot color code are, CH or DH
SFC Dx7	When lower 4 bits of dot color code are, EH or FH

**Note:** A or B is entered in bit name x.

Settings	Process
0	Does not use special functions
1	Uses special functions

• **Character Control (NBG0, NBG1)**

	15	14	13	12	11	10	9	8
CHCTLA	~	~	N1CHCN1	N1CHCN0	N1BMSZ1	N1BMSZ0	N1BMEN	N1CHSZ
180028H	7	6	5	4	3	2	1	0
	~	N0CHCN2	N0CHCN1	N0CHCN0	N0BMSZ1	N0BMSZ0	N0BMEN	N0CHSZ

• **Character Control (NBG2, NBG3, RBG0)**

	15	14	13	12	11	10	9	8
CHCTLB	~	R0CHCN2	R0CHCN1	R0CHCN0	~	R0BMSZ	R0BMEN	R0CHSZ
18002AH	7	6	5	4	3	2	1	0
	~	~	N3CHCN	N3CHSZ	~	~	N2CHCN	N2CHSZ

**Character color number bit (N0CHCN2 to N0CHCN0, N1CHCN1, N1CHCN0, N2CHCN, N3CHCN, R0CHCN2 to R0CHCN0)**

Designates the character color count of each screen and the bit map color count when displaying by the bit map format.

N0CHCN2~N0CHCN0	180028H	Bit 6~4	For NBG0 (or RBG1)
N1CHCN1,N1CHCN0	180028H	Bit 13,12	For NBG1 (or EXBG)
N2CHCN	18002AH	Bit 1	For NBG2
N3CHCN	18002AH	Bit 5	For NBG3
R0CHCN2~R0CHCN0	18002AH	Bit 14~12	For RBG0

N0CHCN2	N0CHCN1	N0CHCN0	TV Screen Mode			Color Format
			Normal	Hi-Res	Exclusive Monitor	
0	0	0	16 colors	16 colors	16 colors	Palette Format
0	0	1	256 colors	256 colors	256 colors	Palette Format
0	1	0	2048 colors	2048 colors	2048 colors	Palette Format
0	1	1	32,786 colors	32,786 colors	32,786 colors	RGB Format
1	0	0	16,770,000 colors	Setting not allowed	Setting not allowed	RGB Format
1	0	1	Setting not allowed (Please do not set.)			
1	1	0	Setting not allowed (Please do not set.)			
1	1	1	Setting not allowed (Please do not set.)			

**Note:** Cannot be displayed by the exclusive monitor mode when used as RBG1.

N1CHCN1	N1CHCN0	TV Screen Mode			Color Format
		Normal	Hi-Res	Exclusive Monitor	
0	0	16 colors	16 colors	16 colors	Palette Format
0	1	256 colors	256 colors	256 colors	Palette Format
1	0	2048 colors	2048 colors	2048 colors	Palette Format
1	1	32,786 colors	32,786 colors	32,786 colors	RGB Format

**Note:** When used as EXBG, and when the set values are N1CHCN1 = 1, N1CHCN0 = 1 there are 16,770,000 colors

NnCHCN0	TV Screen Mode			Color Format
	Normal	Hi-Res	Exclusive Monitor	
0	16 colors	16 colors	16 colors	Palette Format
1	256 colors	256 colors	256 colors	Palette Format

**Note:** 2 or 3 is entered in bit name for n.





R0CHCN2	R0CHCN1	R0CHCN0	TV Screen Mode			Color Format
			Normal	Hi-Res	Exclusive Monitor	
0	0	0	16 colors	16 colors	Cannot Display	Palette Format
0	0	1	256 colors	256 colors	Cannot Display	Palette Format
0	1	0	2048 colors	2048 colors	Cannot Display	Palette Format
0	1	1	32,786 colors	32,786 colors	Cannot Display	RGB Format
1	0	0	16,770,000 colors	Setting not allowed	Cannot Display	RGB Format
1	0	1	Setting not allowed (Please do not set.)			
1	1	0	Setting not allowed (Please do not set.)			
1	1	1	Setting not allowed (Please do not set.)			

**Bit map size bit (NOBMSZ1, NOBMSZ0, N1BMSZ1, N1BMSZ0, ROBMSZ)**

Designates the bit map size of each screen when display is in a bit map format.

NOBMSZ1,NOBMSZ0	180028H	Bit 3,2	For NBG0
N1BMSZ1,N1BMSZ0	180028H	Bit 11,10	For NBG1
ROBMSZ	18002AH	Bit 10	For RBG0

NnBMSZ1	NnBMSZ0	Bitmap Size
0	0	512 H dots X 512 V dots
0	1	512 H dots X 512 V dots
1	0	512 H dots X 512 V dots
1	1	512 H dots X 512 V dots

**Note:** 0 or 1 is entered in bit name for n.

ROBMSZ	Bitmap Size
0	512 H dots X 256 V dots
1	512 H dots X 512 V dots

**Bit map enable bit (NOBMEN, N1BMEN, ROBMEN)**

Designates whether to display the scroll screen in a bit map format.

NOBMEN	180028H	Bit 1	For NBG0
N1BMEN	180028H	Bit 9	For NBG1
ROBMEN	18002AH	Bit 9	For RBG0

xxBMEN	Screen Display Format
0	Cell Format
1	Bitmap Format

**Note:** N0, N1, or R0 is entered in bit name for xx.

**Character size bit (N0CHSZ, N1CHSZ, N2CHSZ, N3CHSZ, R0CHSZ)**

Designates the character size when the scroll screen is in a cell format.

N0CHSZ	180028H	Bit 0	For NBG0 (or RBG1)
N1CHSZ	180028H	Bit 8	For NBG1
N2CHSZ	18002AH	Bit 0	For NBG2
N3CHSZ	18002AH	Bit 4	For NBG3
R0CHSZ	18002AH	Bit 8	For RBG0

xxCHSZ	Character Pattern Size
0	1 H Cell X 1 V Cell
1	2 H Cells X 2 V Cells

**Note:** N0, N1, N2, N3, or R0 is entered in bit name for xx.

• **Bit Map Palette Number (NBG0, NBG1)**

	15	14	13	12	11	10	9	8
BMPNA	~	~	N1BMPPR	N1BMCC	~	N1BMP6	N1BMP5	N1BMP4
18002CH	7	6	5	4	3	2	1	0
	~	~	N0BMPPR	N0BMCC	~	N0BMP6	N0BMP5	N0BMP4

• **Bit Map Palette Number (RBG0)**

	15	14	13	12	11	10	9	8
BMPNB	~	~	~	~	~	~	~	~
18002EH	7	6	5	4	3	2	1	0
	~	~	R0BMPPR	R0BMCC	~	R0BMP6	R0BMP5	R0BMP4

**Special priority bit (for bit map): Bit map special priority bit (N0BMPPR, N1BMPPR, R0BMPPR)**

Designates the special priority bit when the scroll screen is displayed by the bit map format.

N0BMPPR	18002CH	Bit 5	For NBG0
N1BMPPR	18002CH	Bit 13	For NBG1
R0BMPPR	18002EH	Bit 5	For RBG0



**Special color calculation bit (for bit map): Bit map special color calculation bit (N0BMCC, N1BMCC, R0BMCC)**

Designates the special color calculation bit when the scroll screen is displayed by the bit map format.

N0BMCC	18002CH	Bit 4	For NBG0
N1BMCC	18002CH	Bit 12	For NBG1
R0BMCC	18002EH	Bit 4	For RBG0

**Palette number bit (for bit map): Bit map palette number bit (N0BMP6 to N0BMP4, N1BMP6 to N1BMP4, R0BMP6 to R0BMP4)**

Designates the highest 3 bits of the palette number when the scroll screen is displayed in the bit map format.

N0BMP6~N0BMP4	18002CH	Bit 2~0	For NBG0
N1BMP6~N1BMP4	18002CH	Bit 10~8	For NBG1
R0BMP6~R0BMP4	18002EH	Bit 2~0	For RBG0

**• Pattern Name Control (NBG0)**

	15	14	13	12	11	10	9	8
PNCN0	N0PNB	N0CNSM	~	~	~	~	N0SPR	N0SCC
180030H	7	6	5	4	3	2	1	0
	N0SPLT6	N0SPLT5	N0SPLT4	N0SCN4	N0SCN3	N0SCN2	N0SCN1	N0SCN0

**• Pattern Name Control (NBG1)**

	15	14	13	12	11	10	9	8
PNCN1	N1PNB	N1CNSM	~	~	~	~	N1SPR	N1SCC
180032H	7	6	5	4	3	2	1	0
	N1SPLT6	N1SPLT5	N1SPLT4	N1SCN4	N1SCN3	N1SCN2	N1SCN1	N1SCN0

**• Pattern Name Control (NBG2)**

	15	14	13	12	11	10	9	8
PNCN2	N2PNB	N2CNSM	~	~	~	~	N2SPR	N2SCC
180034H	7	6	5	4	3	2	1	0
	N2SPLT6	N2SPLT5	N2SPLT4	N2SCN4	N2SCN3	N2SCN2	N2SCN1	N2SCN0

**• Pattern Name Control (NBG3)**

	15	14	13	12	11	10	9	8
PNCN3	N3PNB	N3CNSM	~	~	~	~	N3SPR	N3SCC
180036H	7	6	5	4	3	2	1	0
	N3SPLT6	N3SPLT5	N3SPLT4	N3SCN4	N3SCN3	N3SCN2	N3SCN1	N3SCN0

• **Pattern Name Control (RBG0)**

	15	14	13	12	11	10	9	8
PNCR	R0PNB	R0CNSM	~	~	~	~	R0SPR	R0SCC
180038H	7	6	5	4	3	2	1	0
	R0SPLT6	R0SPLT5	R0SPLT4	R0SCN4	R0SCN3	R0SCN2	R0SCN1	R0SCN0

**Pattern name data size bit (N0PNB, N1PNB, N2PNB, N3PNB, R0PNB)**

Designates the pattern name data size when displaying in the cell format.

N0PNB	180030H	Bit 15	For NBG0 (or RBG1)
N1PNB	180032H	Bit 15	For NBG1
N2PNB	180034H	Bit 15	For NBG2
N3PNB	180036H	Bit 15	For NBG3
R0PNB	180038H	Bit 15	For RBG0

xxPNB	Pattern Name Data Size
0	2 Words
1	1 Word

**Note:** N0, N1, N3, or R0 is entered in bit name for xx.

**Character number supplement bit (N0CNSM, N1CNSM, N2CNSM, N3CNSM, R0CNSM)**

Designates the character number supplement mode when the pattern name data size in the pattern name table is 1-word.

N0CNSM	180030H	Bit 14	For NBG0 (or RBG1)
N1CNSM	180032H	Bit 14	For NBG1
N2CNSM	180034H	Bit 14	For NBG2
N3CNSM	180036H	Bit 14	For NBG3
R0CNSM	180038H	Bit 14	For RBG0

xxCNSM	Character Number Auxiliary Mode	Process
0	0	Character number in pattern name data is 10 bits. Flip function can be selected in character units.
1	1	Character number in pattern name data is 12 bits. Flip function cannot be used.

**Note:** N0, N1, N2, N3, or R0 is entered in bit name for xx.



**Special priority bit (for pattern name supplement data): Supplement special priority bit (N0SPR, N1SPR, N2SPR, N3SPR, R0SPR)**

Designates the pattern name supplement data as the special priority bit when the pattern name data size is 1-word.

N0SPR	180030H	Bit 9	For NBG0 (or RBG1)
N1SPR	180032H	Bit 9	For NBG1
N2SPR	180034H	Bit 9	For NBG2
N3SPR	180036H	Bit 9	For NBG3
R0SPR	180038H	Bit 9	For RBG0

**Special color calculation bit (for pattern name supplement data): Supplementary special color calculation bit (N0SCC, N1SCC, N2SCC, N3SCC, R0SCC)**

The special color calculation bit is designated as pattern name supplement data when the pattern name data size is 1-word.

N0SCC	180030H	Bit 8	For NBG0 (or RBG 1)
N1SCC	180032H	Bit 8	For NBG1
N2SCC	180034H	Bit 8	For NBG2
N3SCC	180036H	Bit 8	For NBG3
R0SCC	180038H	Bit 8	For RBG0

**Supplementary palette number bit (N0SPLT6 to N0SPLT4, N1SPLT6 to N1SPLT4, N2SPLT6 to N2SPLT4, N3SPLT6 to N3SPLT4, R0SPLT6 to R0SPLT4)**

Designates the palette number bit as pattern name supplement data when the pattern name data size is 1-word. Three bits are added to the palette number bit of the pattern name data for the supplementary palette number bit.

N0SPLT6~N0SPLT4	180030H	Bit 7~5	For NBG0 (or RBG 1)
N1SPLT6~N1SPLT4	180032H	Bit 7~5	For NBG1
N2SPLT6~N2SPLT4	180034H	Bit 7~5	For NBG2
N3SPLT6~N3SPLT4	180036H	Bit 7~5	For NBG3
R0SPLT6~R0SPLT4	180038H	Bit 7~5	For RBG0

**Supplementary character number bit (N0SCN4 to N0SCN0, N1SCN4 to N1SCN0, N2SCN4 to N2SCN0, N3SCN4 to N3SCN0, R0SCN4 to R0SCN0)**

Designates the character number bit as the pattern name supplement data when the pattern name data size is 1-word. Five bits are added to the palette number bit of the pattern name data for the supplementary palette number bit.

N0SCN4~N0SCN0	180030H	Bit 4~0	For NBG0 (or RBG 1)
N1SCN4~N1SCN0	180032H	Bit 4~0	For NBG1
N2SCN4~N2SCN0	180034H	Bit 4~0	For NBG2
N3SCN4~N3SCN0	180036H	Bit 4~0	For NBG3
R0SCN4~R0SCN0	180038H	Bit 4~0	For RBG0

### Plane Size

	15	14	13	12	11	10	9	8
PLSZ	RBOVR1	RBOVR0	RBPLSZ1	RBPLSZ0	RAOVR1	RAOVR0	RAPLSZ1	RAPLSZ0
18003AH	7	6	5	4	3	2	1	0
	N3PLSZ1	N3PLSZ0	N2PLSZ1	N2PLSZ0	N1PLSZ1	N1PLSZ0	N0PLSZ1	N0PLSZ0

**Plane size bit (N0PLSZ1, N0PLSZ0, N1PLSZ1, N1PLSZ0, N2PLSZ1, N2PLSZ0, N3PLSZ1, N3PLSZ0, RAPLSZ1, RAPLSZ0, RBPLSZ1, RBPLSZ0)**  
Designates the plane size (number of pages) of each scroll screen.

N0PLSZ1, N0PLSZ0	18003AH	Bit 1,0	For NBG0
N1PLSZ1, N1PLSZ0	18003AH	Bit 3,2	For NBG1
N2PLSZ1, N2PLSZ0	18003AH	Bit 5,4	For NBG2
N3PLSZ1, N3PLSZ0	18003AH	Bit 7,6	For NBG3
RAPLSZ1, RAPLSZ0	18003AH	Bit 9,8	For Rotation Parameter A
RBPLSZ1, RBPLSZ0	18003AH	Bit 13,12	For Rotation Parameter B

xxPLSZ1	xxPLSZ0	Plane Size
0	0	1 H Page X 1 V Page
0	1	2 H Pages X 1 V Page
1	0	Invalid (Do not set.)
1	1	2 H Pages X 2 V Pages

**Note:** N0, N1, N2, N3, RA, or RB is entered in bit name for xx.



**Screen-over process bit: Over bit (RAOVR1, RAOVR0, RBOVR1, RBOVR0)**

Designates control (screen-over process) when the display coordinate value exceeds the display area in the rotation scroll screen.

RAOVR1, RAOVR0	18003AH	Bit 11,10	For Rotation Parameter A
RBOVR1, RBOVR0	18003AH	Bit 15,14	For Rotation Parameter B

RxOVR1	RxOVR0	Screen Over Process
0	0	Outside the display area, the image set in the display area is repeated.
0	1	Outside the display area, the character pattern specified by screen over pattern name register is repeated. (Only when the rotation scroll screen is in cell format.)
1	0	Outside the display area, the scroll screen is transparent,
1	1	Set the display area as $0 \leq X \leq 512$ , $0 \leq Y \leq 512$ regardless of plane size or bitmap size and make that area transparent.

Note: A or B is entered in bit name for x.

**• Map Offset (NBG0~NBG3)**

	15	14	13	12	11	10	9	8
MPOFN	~	N3MP8	N3MP7	N3MP6	~	N2MP8	N2MP7	N2MP6
18003CH	7	6	5	4	3	2	1	0
	~	N1MP8	N1MP7	N1MP6	~	N0MP8	N0MP7	N0MP6

**• Map Offset (Rotation Parameter A, B)**

	15	14	13	12	11	10	9	8
MPOFR	~	~	~	~	~	~	~	~
18003EH	7	6	5	4	3	2	1	0
	~	RBMP8	RBMP7	RBMP6	~	RAMP8	RAMP7	RAMP6

**Map offset bit (N0MP8 to N0MP6, N1MP8 to N1MP6, N2MP8 to N2MP6, N3MP8 to N3MP6, RAMP8 to RAMP6, RBMP8 to RBMP6)**

When the scroll screen display format is the cell format, the map offset value of 3 bits is added to the highest 6 bits of the map register. This designates the bit map pattern boundary when in the bit map format.

N0MP8~N0MP6	18003CH	Bit 2~0	For NBG0
N1MP8~N1MP6	18003CH	Bit 6~4	For NBG1
N2MP8~N2MP6	18003CH	Bit 10~8	For NBG2
N3MP8~N3MP6	18003CH	Bit 14~12	For NBG3
RAMP8~RAMP6	18003EH	Bit 2~0	For Rotation Parameter A
RBMP8~RBMP6	18003EH	Bit 6~4	For Rotation Parameter B

• Map (NBG0, Plane A, B)

	15	14	13	12	11	10	9	8
MPABN0	~	~	N0MPB5	N0MPB4	N0MPB3	N0MPB2	N0MPB1	N0MPB0
180040H	7	6	5	4	3	2	1	0
	~	~	N0MPA5	N0MPA4	N0MPA3	N0MPA2	N0MPA1	N0MPA0

• Map (NBG0, Plane C, D)

	15	14	13	12	11	10	9	8
MPCDN0	~	~	N0MPD5	N0MPD4	N0MPD3	N0MPD2	N0MPD1	N0MPD0
180042H	7	6	5	4	3	2	1	0
	~	~	N0MPC5	N0MPC4	N0MPC3	N0MPC2	N0MPC1	N0MPC0

• Map (NBG1, Plane A, B)

	15	14	13	12	11	10	9	8
MPABN1	~	~	N1MPB5	N1MPB4	N1MPB3	N1MPB2	N1MPB1	N1MPB0
180044H	7	6	5	4	3	2	1	0
	~	~	N1MPA5	N1MPA4	N1MPA3	N1MPA2	N1MPA1	N1MPA0

• Map (NBG1, Plane C, D)

	15	14	13	12	11	10	9	8
MPCDN1	~	~	N1MPD5	N1MPD4	N1MPD3	N1MPD2	N1MPD1	N1MPD0
180046H	7	6	5	4	3	2	1	0
	~	~	N1MPC5	N1MPC4	N1MPC3	N1MPC2	N1MPC1	N1MPC0

• Map (NBG2, Plane A, B)

	15	14	13	12	11	10	9	8
MPABN2	~	~	N2MPB5	N2MPB4	N2MPB3	N2MPB2	N2MPB1	N2MPB0
180048H	7	6	5	4	3	2	1	0
	~	~	N2MPA5	N2MPA4	N2MPA3	N2MPA2	N2MPA1	N2MPA0

• Map (NBG2, Plane C, D)

	15	14	13	12	11	10	9	8
MPCDN2	~	~	N2MPD5	N2MPD4	N2MPD3	N2MPD2	N2MPD1	N2MPD0
18004AH	7	6	5	4	3	2	1	0
	~	~	N2MPC5	N2MPC4	N2MPC3	N2MPC2	N2MPC1	N2MPC0

• Map (NBG3, Plane A, B)

	15	14	13	12	11	10	9	8
MPABN3	~	~	N3MPB5	N3MPB4	N3MPB3	N3MPB2	N3MPB1	N3MPB0
18004CH	7	6	5	4	3	2	1	0
	~	~	N3MPA5	N3MPA4	N3MPA3	N3MPA2	N3MPA1	N3MPA0





• Map (NBG3, Plane C, D)

	15	14	13	12	11	10	9	8
MPCDN3	~	~	N3MPD5	N3MPD4	N3MPD3	N3MPD2	N3MPD1	N3MPD0
18004EH	7	6	5	4	3	2	1	0
	~	~	N3MPC5	N3MPC4	N3MPC3	N3MPC2	N3MPC1	N3MPC0

Map bit (for normal scroll): (N0MPA5 to N0MPA0, N0MPB5 to N0MPB0, N0MPC5 to N0MPC0, N0MPD5 to N0MPD0, N1MPA5 to N1MPA0, N1MPB5 to N1MPB0, N1MPC5 to N1MPC0, N1MPD5 to N1MPD0, N2MPA5 to N2MPA0, N2MPB5 to N2MPB0, N2MPC5 to N2MPC0, N2MPD5 to N2MPD0, N3MPA5 to N3MPA0, N3MPB5 to N3MPB0, N3MPC5 to N3MPC0, N3MPD5 to N3MPD0)

When the Normal scroll screen is displayed by the cell format, the lead address for the pattern name table is designated for each plane.

N0MPA5~N0MPA0	180040H	Bit 5~0	For NBG0 Plane A
N0MPB5~N0MPB0	180040H	Bit 13~8	For NBG0 Plane B
N0MPC5~N0MPC0	180042H	Bit 5~0	For NBG0 Plane C
N0MPD5~N0MPD0	180042H	Bit 13~8	For NBG0 Plane D
N1MPA5~N1MPA0	180044H	Bit 5~0	For NBG1 Plane A
N1MPB5~N1MPB0	180044H	Bit 13~8	For NBG1 Plane B
N1MPC5~N1MPC0	180046H	Bit 5~0	For NBG1 Plane C
N1MPD5~N1MPD0	180046H	Bit 13~8	For NBG1 Plane D
N2MPA5~N2MPA0	180048H	Bit 5~0	For NBG2 Plane A
N2MPB5~N2MPB0	180048H	Bit 13~8	For NBG2 Plane B
N2MPC5~N2MPC0	18004AH	Bit 5~0	For NBG2 Plane C
N2MPD5~N2MPD0	18004AH	Bit 13~8	For NBG2 Plane D
N3MPA5~N3MPA0	18004CH	Bit 5~0	For NBG3 Plane A
N3MPB5~N3MPB0	18004CH	Bit 13~8	For NBG3 Plane B
N3MPC5~N3MPC0	18004EH	Bit 5~0	For NBG3 Plane C
N3MPD5~N3MPD0	18004EH	Bit 13~8	For NBG3 Plane D

• Map (Rotation Parameter A, Plane A, B)

	15	14	13	12	11	10	9	8
MPBRAB	~	~	RAMPB5	RAMPB4	RAMPB3	RAMPB2	RAMPB1	RAMPB0
180050H	7	6	5	4	3	2	1	0
	~	~	RAMPA5	RAMPA4	RAMPA3	RAMPA2	RAMPA1	RAMPA0

• Map (Rotation Parameter A, Plane C, D)

	15	14	13	12	11	10	9	8
MPCDRA	~	~	RAMPD5	RAMPD4	RAMPD3	RAMPD2	RAMPD1	RAMPD0
180052H	7	6	5	4	3	2	1	0
	~	~	RAMPC5	RAMPC4	RAMPC3	RAMPC2	RAMPC1	RAMPC0

• Map (Rotation Parameter A, Plane E, F)

	15	14	13	12	11	10	9	8
MPEFRA	~	~	RAMPF5	RAMPF4	RAMPF3	RAMPF2	RAMPF1	RAMPF0
180054H	7	6	5	4	3	2	1	0
	~	~	RAMPE5	RAMPE4	RAMPE3	RAMPE2	RAMPE1	RAMPE0

• Map (Rotation Parameter A, Plane G, H)

	15	14	13	12	11	10	9	8
MPGHRA	~	~	RAMPH5	RAMPH4	RAMPH3	RAMPH2	RAMPH1	RAMPH0
180056H	7	6	5	4	3	2	1	0
	~	~	RAMPG5	RAMPG4	RAMPG3	RAMPG2	RAMPG1	RAMPG0

• Map (Rotation Parameter A, Plane I, J)

	15	14	13	12	11	10	9	8
MPIJRA	~	~	RAMPJ5	RAMPJ4	RAMPJ3	RAMPJ2	RAMPJ1	RAMPJ0
180058H	7	6	5	4	3	2	1	0
	~	~	RAMPI5	RAMPI4	RAMPI3	RAMPI2	RAMPI1	RAMPI0

• Map (Rotation Parameter A, Plane K, L)

	15	14	13	12	11	10	9	8
MPKLRA	~	~	RAMPL5	RAMPL4	RAMPL3	RAMPL2	RAMPL1	RAMPL0
18005AH	7	6	5	4	3	2	1	0
	~	~	RAMPK5	RAMPK4	RAMPK3	RAMPK2	RAMPK1	RAMPK0

• Map (Rotation Parameter A, Plane M, N)

	15	14	13	12	11	10	9	8
MPMNRA	~	~	RAMPN5	RAMPN4	RAMPN3	RAMPN2	RAMPN1	RAMPN0
18005CH	7	6	5	4	3	2	1	0
	~	~	RAMPM5	RAMPM4	RAMPM3	RAMPM2	RAMPM1	RAMPM0



• Map (Rotation Parameter A, Plane O, P)

	15	14	13	12	11	10	9	8
MPOPR	~	~	RAMPP5	RAMPP4	RAMPP3	RAMPP2	RAMPP1	RAMPP0
18005EH	7	6	5	4	3	2	1	0
	~	~	RAMPO5	RAMPO4	RAMPO3	RAMPO2	RAMPO1	RAMPO0

• Map (Rotation Parameter B, Plane A, B)

	15	14	13	12	11	10	9	8
MPABRB	~	~	RBMPB5	RBMPB4	RBMPB3	RBMPB2	RBMPB1	RBMPB0
180060H	7	6	5	4	3	2	1	0
	~	~	RBMPA5	RBMPA4	RBMPA3	RBMPA2	RBMPA1	RBMPA0

• Map (Rotation Parameter B, Plane C, D)

	15	14	13	12	11	10	9	8
MPCDRB	~	~	RBMPD5	RBMPD4	RBMPD3	RBMPD2	RBMPD1	RBMPD0
180062H	7	6	5	4	3	2	1	0
	~	~	RBMPC5	RBMPC4	RBMPC3	RBMPC2	RBMPC1	RBMPC0

• Map (Rotation Parameter B, Plane E, F)

	15	14	13	12	11	10	9	8
MPEFRB	~	~	RBMPF5	RBMPF4	RBMPF3	RBMPF2	RBMPF1	RBMPF0
180064H	7	6	5	4	3	2	1	0
	~	~	RBMPE5	RBMPE4	RBMPE3	RBMPE2	RBMPE1	RBMPE0

• Map (Rotation Parameter B, Plane G, H)

	15	14	13	12	11	10	9	8
MPGHRB	~	~	RBMPH5	RBMPH4	RBMPH3	RBMPH2	RBMPH1	RBMPH0
180066H	7	6	5	4	3	2	1	0
	~	~	RBMPG5	RBMPG4	RBMPG3	RBMPG2	RBMPG1	RBMPG0

• Map (Rotation Parameter B, Plane I, J)

	15	14	13	12	11	10	9	8
MPIJRB	~	~	RBMPJ5	RBMPJ4	RBMPJ3	RBMPJ2	RBMPJ1	RBMPJ0
180068H	7	6	5	4	3	2	1	0
	~	~	RBMPI5	RBMPI4	RBMPI3	RBMPI2	RBMPI1	RBMPI0

• Map (Rotation Parameter B, Plane K, L)

	15	14	13	12	11	10	9	8
MPKLRB	~	~	RB MPL5	RB MPL4	RB MPL3	RB MPL2	RB MPL1	RB MPL0
18006AH	7	6	5	4	3	2	1	0
	~	~	RBMPK5	RBMPK4	RBMPK3	RBMPK2	RBMPK1	RBMPK0

• **Map (Rotation Parameter B, Plane M, N)**

	15	14	13	12	11	10	9	8
MPMNRB	~	~	RBMPN5	RBMPN4	RBMPN3	RBMPN2	RBMPN1	RBMPN0
18006CH	7	6	5	4	3	2	1	0
	~	~	RBMPM5	RBMPM4	RBMPM3	RBMPM2	RBMPM1	RBMPM0

• **Map (Rotation Parameter B, Plane O, P)**

	15	14	13	12	11	10	9	8
MPOPRB	~	~	RBMPPO5	RBMPPO4	RBMPPO3	RBMPPO2	RBMPPO1	RBMPPO0
18006EH	7	6	5	4	3	2	1	0
	~	~	RBMPO5	RBMPO4	RBMPO3	RBMPO2	RBMPO1	RBMPO0

**Map bit (for rotation scroll):** Map bit (RAMPA5 to RAMPA0, RAMPB5 to RAMPB0, RAMPC5 to RAMPC0, RAMPD5 to RAMPD0, RAMPE5 to RAMPE0, RAMPF5 to RAMPF0, RAMPG5 to RAMPG0, RAMPH5 to RAMPH0, RAMPI5 to RAMPI0, RAMPJ5 to RAMPJ0, RAMPK5 to RAMPK0, RAMPL5 to RAMPL0, RAMPM5 to RAMPM0, RAMPN5 to RAMPN0, RAMPO5 to RAMPO0, RAMPP5 to RAMPP0, RBMPA5 to RBMPA0, RBMPB5 to RBMPB0, RBMPC5 to RBMPC0, RBMPD5 to RBMPD0, RBMPE5 to RBMPE0, RBMPF5 to RBMPF0, RBMPG5 to RBMPG0, RBMPH5 to RBMPH0, RBMPI5 to RBMPI0, RBMPJ5 to RBMPJ0, RBMPK5 to RBMPK0, RBMPL5 to RBMPL0, RBMPM5 to RBMPM0, RBMPN5 to RBMPN0, RBMPO5 to RBMPO0, RBMPP5 to RBMPP0)

Designates the lead address of the pattern name table being arranged in each plane when a rotation scroll screen is displayed in the cell format.



RAMPA5~RAMPA0	180050H	Bit 5~0	Rotation Parameter A for Screen Plane A
RAMPB5~RAMPB0	180050H	Bit 13~8	Rotation Parameter A for Screen Plane B
RAMPC5~RAMPC0	180052H	Bit 5~0	Rotation Parameter A for Screen Plane C
RAMPD5~RAMPD0	180052H	Bit 13~8	Rotation Parameter A for Screen Plane D
RAMPE5~RAMPE0	180054H	Bit 5~0	Rotation Parameter A for Screen Plane E
RAMPF5~RAMPF0	180054H	Bit 13~8	Rotation Parameter A for Screen Plane F
RAMPG5~RAMPG0	180056H	Bit 5~0	Rotation Parameter A for Screen Plane G
RAMPH5~RAMPH0	180056H	Bit 13~8	Rotation Parameter A for Screen Plane H
RAMPI5~RAMPI0	180058H	Bit 5~0	Rotation Parameter A for Screen Plane I
RAMPJ5~RAMPJ0	180058H	Bit 13~8	Rotation Parameter A for Screen Plane J
RAMPK5~RAMPK0	18005AH	Bit 5~0	Rotation Parameter A for Screen Plane K
RAMPL5~RAMPL0	18005AH	Bit 13~8	Rotation Parameter A for Screen Plane L
RAMPM5~RAMPM0	18005CH	Bit 5~0	Rotation Parameter A for Screen Plane M
RAMPN5~RAMPN0	18005CH	Bit 13~8	Rotation Parameter A for Screen Plane N
RAMPO5~RAMPO0	18005EH	Bit 5~0	Rotation Parameter A for Screen Plane O
RAMPP5~RAMPP0	18005EH	Bit 13~8	Rotation Parameter A for Screen Plane P
RBMPA5~RBMPA0	180060H	Bit 5~0	Rotation Parameter B for Screen Plane A
RBMPB5~RBMPB0	180060H	Bit 13~8	Rotation Parameter B for Screen Plane B
RBMPC5~RBMPC0	180062H	Bit 5~0	Rotation Parameter B for Screen Plane C
RBMPD5~RBMPD0	180062H	Bit 13~8	Rotation Parameter B for Screen Plane D
RBMPE5~RBMPE0	180064H	Bit 5~0	Rotation Parameter B for Screen Plane E
RBMPF5~RBMPF0	180064H	Bit 13~8	Rotation Parameter B for Screen Plane F
RBMPG5~RBMPG0	180066H	Bit 5~0	Rotation Parameter B for Screen Plane G
RBMPH5~RBMPH0	180066H	Bit 13~8	Rotation Parameter B for Screen Plane H
RBMPI5~RBMPI0	180068H	Bit 5~0	Rotation Parameter B for Screen Plane I
RBMPJ5~RBMPJ0	180068H	Bit 13~8	Rotation Parameter B for Screen Plane J
RBMPK5~RBMPK0	18006AH	Bit 5~0	Rotation Parameter B for Screen Plane K
RBMPL5~RBMPL0	18006AH	Bit 13~8	Rotation Parameter B for Screen Plane L
RBMPM5~RBMPM0	18006CH	Bit 5~0	Rotation Parameter B for Screen Plane M
RBMPN5~RBMPN0	18006CH	Bit 13~8	Rotation Parameter B for Screen Plane N
RBMPO5~RBMPO0	18006EH	Bit 5~0	Rotation Parameter B for Screen Plane O
RBMPJ5~RBMPJ0	18006EH	Bit 13~8	Rotation Parameter B for Screen Plane P

• **Screen Scroll Value (NBG0, Horizontal Integer Part)**

	15	14	13	12	11	10	9	8
SCXIN0	~	~	~	~	~	N0SCXI10	N0SCXI9	N0SCXI8
180070H	7	6	5	4	3	2	1	0
	N0SCXI7	N0SCXI6	N0SCXI5	N0SCXI4	N0SCXI3	N0SCXI2	N0SCXI1	N0SCXI0

• **Screen Scroll Value (NBG0, Horizontal Fractional Part)**

	15	14	13	12	11	10	9	8
SCXDNO	N0SCXD1	N0SCXD2	N0SCXD3	N0SCXD4	N0SCXD5	N0SCXD6	N0SCXD7	N0SCXD8
180072H	7	6	5	4	3	2	1	0
	~	~	~	~	~	~	~	~

• **Screen Scroll Value (NBG0, Vertical Integer Part)**

	15	14	13	12	11	10	9	8
SCYIN0	~	~	~	~	~	N0SCYI10	N0SCYI9	N0SCYI8
180074H	7	6	5	4	3	2	1	0
	N0SCYI7	N0SCYI6	N0SCYI5	N0SCYI4	N0SCYI3	N0SCYI2	N0SCYI1	N0SCYI0

• **Screen Scroll Value (NBG0, Vertical Fractional Part)**

	15	14	13	12	11	10	9	8
SCYDNO	N0SCYD1	N0SCYD2	N0SCYD3	N0SCYD4	N0SCYD5	N0SCYD6	N0SCYD7	N0SCYD8
180076H	7	6	5	4	3	2	1	0
	~	~	~	~	~	~	~	~

• **Coordinate Increment (NBG0, Horizontal Integer Part)**

	15	14	13	12	11	10	9	8
ZMXIN0	~	~	~	~	~	~	~	~
180078H	7	6	5	4	3	2	1	0
	~	~	~	~	~	N0ZMXI2	N0ZMXI1	N0ZMXI0

• **Coordinate Increment (NBG0, Horizontal Fractional Part)**

	15	14	13	12	11	10	9	8
ZMXDNO	N0ZMXD1	N0ZMXD2	N0ZMXD3	N0ZMXD4	N0ZMXD5	N0ZMXD6	N0ZMXD7	N0ZMXD8
18007AH	7	6	5	4	3	2	1	0
	~	~	~	~	~	~	~	~

• **Coordinate Increment (NBG0, Vertical Integer Part)**

	15	14	13	12	11	10	9	8
ZMYIN0	~	~	~	~	~	~	~	~
18007CH	7	6	5	4	3	2	1	0
	~	~	~	~	~	N0ZMYI2	N0ZMYI1	N0ZMYI0

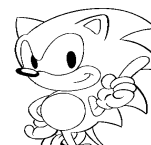

• **Coordinate Increment (NBG0, Vertical Fractional Part)**

	15	14	13	12	11	10	9	8
ZMYDN0	N0ZMYD1	N0ZMYD2	N0ZMYD3	N0ZMYD4	N0ZMYD5	N0ZMYD6	N0ZMYD7	N0ZMYD8
18007EH	7	6	5	4	3	2	1	0
	~	~	~	~	~	~	~	~

• **Screen Scroll Value (NBG1, Horizontal Integer Part)**

	15	14	13	12	11	10	9	8
SCXIN1	~	~	~	~	~	N1SCXI10	N1SCXI9	N1SCXI8
180080H	7	6	5	4	3	2	1	0
	N1SCXI7	N1SCXI6	N1SCXI5	N1SCXI4	N1SCXI3	N1SCXI2	N1SCXI1	N1SCXI0

• **Screen Scroll Value (NBG1, Horizontal Fractional Part)**

	15	14	13	12	11	10	9	8
SCXDN1	N1SCXD1	N1SCXD2	N1SCXD3	N1SCXD4	N1SCXD5	N1SCXD6	N1SCXD7	N1SCXD8
180082H	7	6	5	4	3	2	1	0
	~	~	~	~	~	~	~	~

• **Screen Scroll Value (NBG1, Vertical Integer Part)**

	15	14	13	12	11	10	9	8
SCYIN1	~	~	~	~	~	N1SCYI10	N1SCYI9	N1SCYI8
180084H	7	6	5	4	3	2	1	0
	N1SCYI7	N1SCYI6	N1SCYI5	N1SCYI4	N1SCYI3	N1SCYI2	N1SCYI1	N1SCYI0

• **Screen Scroll Value (NBG1, Vertical Fractional Part)**

	15	14	13	12	11	10	9	8
SCYDN1	N1SCYD1	N1SCYD2	N1SCYD3	N1SCYD4	N1SCYD5	N1SCYD6	N1SCYD7	N1SCYD8
180086H	7	6	5	4	3	2	1	0
	~	~	~	~	~	~	~	~

• **Coordinate Increment (NBG1, Horizontal Integer Part)**

	15	14	13	12	11	10	9	8
ZMXIN1	~	~	~	~	~	~	~	~
180088H	7	6	5	4	3	2	1	0
	~	~	~	~	~	N1ZMXI2	N1ZMXI1	N1ZMXI0

• **Coordinate Increment (NBG1, Horizontal Fractional Part)**

	15	14	13	12	11	10	9	8
ZMXDN1	N1ZMXD1	N1ZMXD2	N1ZMXD3	N1ZMXD4	N1ZMXD5	N1ZMXD6	N1ZMXD7	N1ZMXD8
18008AH	7	6	5	4	3	2	1	0
	~	~	~	~	~	~	~	~

• **Coordinate Increment (NBG1, Vertical Integer Part)**

	15	14	13	12	11	10	9	8
ZMYIN1	~	~	~	~	~	~	~	~
18008CH	7	6	5	4	3	2	1	0
	~	~	~	~	~	N1ZMYI2	N1ZMYI1	N1ZMYI0

• **Coordinate Increment (NBG1, Vertical Fractional Part)**

	15	14	13	12	11	10	9	8
ZMYDN1	N1ZMYD1	N1ZMYD2	N1ZMYD3	N1ZMYD4	N1ZMYD5	N1ZMYD6	N1ZMYD7	N1ZMYD8
18008EH	7	6	5	4	3	2	1	0
	~	~	~	~	~	~	~	~

• **Screen Scroll Value (NBG2, Horizontal)**

	15	14	13	12	11	10	9	8
SCXN2	~	~	~	~	~	N2SCX10	N2SCX9	N2SCX8
180090H	7	6	5	4	3	2	1	0
	N2SCX7	N2SCX6	N2SCX5	N2SCX4	N2SCX3	N2SCX2	N2SCX1	N2SCX0

• **Screen Scroll Value (NBG2, Vertical)**

	15	14	13	12	11	10	9	8
SCYN2	~	~	~	~	~	N2SCY10	N2SCY9	N2SCY8
180092H	7	6	5	4	3	2	1	0
	N2SCY7	N2SCY6	N2SCY5	N2SCY4	N2SCY3	N2SCY2	N2SCY1	N2SCY0

• **Screen Scroll Value (NBG3, Horizontal)**

	15	14	13	12	11	10	9	8
SCXN3	~	~	~	~	~	N3SCX10	N3SCX9	N3SCX8
180094H	7	6	5	4	3	2	1	0
	N3SCX7	N3SCX6	N3SCX5	N3SCX4	N3SCX3	N3SCX2	N3SCX1	N3SCX0

• **Screen Scroll Value (NBG3, Vertical)**

	15	14	13	12	11	10	9	8
SCYN3	~	~	~	~	~	N3SCY10	N3SCY9	N3SCY8
180096H	7	6	5	4	3	2	1	0
	N3SCY7	N3SCY6	N3SCY5	N3SCY4	N3SCY3	N3SCY2	N3SCY1	N3SCY0

**Screen scroll value bit:** Scroll bit (N0SCXI10 to N0SCXI0, N0SCXD1 to N0SCXD8, N0SCYI10 to N0SCYI0, N0SCYD1 to N0SCYD8, N1SCXI10 to N1SCXI0, N1SCXD1 to N1SCXD8, N1SCYI10 to N1SCYI0, N1SCYD1 to N1SCYD8, N2SCX10 to N2SCX0, N2SCY10 to N2SCY0, N3SCX10 to N3SCX0, N3SCY10 to N3SCY0)

Designates the horizontal and vertical screen scroll values (coordinate values) of the Normal scroll screen.





N0SCXI10~N0SCXI0	180070H	Bit 10~0	For NBG0 horizontal direction (integer part)
N0SCXD1~N0SCXD8	180072H	Bit 15~8	For NBG0 horizontal direction (fractional part)
N0SCYI10~N0SCYI0	180074H	Bit 10~0	For NBG0 vertical direction (integer part)
N0SCYD1~N0SCYD8	180076H	Bit 15~8	For NBG0 vertical direction (fractional part)
N1SCXI10~N1SCXI0	180080H	Bit 10~0	For NBG1 horizontal direction (integer part)
N1SCXD1~N1SCXD8	180082H	Bit 15~8	For NBG1 horizontal direction (fractional part)
N1SCYI10~N1SCYI0	180084H	Bit 10~0	For NBG1 vertical direction (integer part)
N1SCYD1~N1SCYD8	180086H	Bit 15~8	For NBG1 vertical direction (fractional part)
N2SCX10~N2SCX0	180090H	Bit 10~0	For NBG2 horizontal direction
N2SCY10~N2SCY0	180092H	Bit 10~0	For NBG2 vertical direction
N3SCX10~N3SCX0	180094H	Bit 10~0	For NBG3 horizontal direction
N3SCY10~N3SCY0	180096H	Bit 10~0	For NBG3 vertical direction

**Coordinate increment bit: Zoom bit (N0ZMXI2 to N0ZMXI0, N0ZMXD1 to N0ZMXD8, N0ZMYI2 to N0ZMYI0, N0ZMYD1 to N0ZMYD8, N1ZMXI2 to N1ZMXI0, N1ZMXD1 to N1ZMXD8, N1ZMYI2 to N1ZMYI0, N1ZMYD1 to N1ZMYD8)**

Designates horizontal and vertical coordinate increments for calculating display coordinates when expanding and reducing all Normal scroll screens.

N0ZMXI2~N0ZMXI0	180078H	Bit 2~0	For NBG0 horizontal direction (integer part)
N0ZMXD1~N0ZMXD8	18007AH	Bit 15~8	For NBG0 horizontal direction (fractional part)
N0ZMYI2~N0ZMYI0	18007CH	Bit 2~0	For NBG0 vertical direction (integer part)
N0ZMYD1~N0ZMYD8	18007EH	Bit 15~8	For NBG0 vertical direction (fractional part)
N1ZMXI2~N1ZMXI0	180088H	Bit 2~0	For NBG1 horizontal direction (integer part)
N1ZMXD1~N1ZMXD8	18008AH	Bit 15~8	For NBG1 horizontal direction (fractional part)
N1ZMYI2~N1ZMYI0	18008CH	Bit 2~0	For NBG1 vertical direction (integer part)
N1ZMYD1~N1ZMYD8	18008EH	Bit 15~8	For NBG1 vertical direction (fractional part)

• **Reduction Enable**

	15	14	13	12	11	10	9	8
ZMCTL	~	~	~	~	~	~	N1ZMQT	N1ZMHF
180098H	7	6	5	4	3	2	1	0
	~	~	~	~	~	~	N0ZMQT	N0ZMHF

**Reduction enable bit: Zoom quarter/half bit (N1ZMQT, N1ZMHF, N0ZMQT, N0ZMHF)**

Designates the maximum reducible range of each Normal scroll screen in the horizontal direction.

N0ZMHF	180098H	Bit 0	For NBG0
N0ZMQT	180098H	Bit 1	For NBG0
N1ZMHF	180098H	Bit 8	For NBG1
N1ZMQT	180098H	Bit 9	For NBG1

NxZMQT	NxZMHF	Horizontal Reduction Display	Restriction Items
0	0	Not allowed	None
0	1	Up to 1/2	The number of character colors can be set for 16 or 256 colors only.
1	0	Up to 1/4	The number of character colors can be set for 16 colors only.
1	1	Up to 1/4	The number of character colors can be set for 16 colors only.

**Note:** 0 or 1 is entered in bit name for x.

#### • Line and Vertical Cell Scroll Control (NBG0, NBG1)

	15	14	13	12	11	10	9	8
SCRCTL	~	~	N1LSS1	N1LSS0	N1LZMX	N1LSCY	N1LSCX	N1VCSC
18009AH	7	6	5	4	3	2	1	0
	~	~	N0LSS1	N0LSS0	N0LZMX	N0LSCY	N0LSCX	N0VCSC

#### Line Scroll Interval Bit: Line scroll select bit (N0LSS1, N0LSS0, N1LSS1, N1LSS0)

Designates the interval that reads line scroll table data from the table. The interval changes depending on the interlace of the TV screen.

N0LSS1, N0LSS0	18009AH	Bit 5, 4	For NBG0
N1LSS1, N1LSS0	18009AH	Bit 13,12	For NBG1

NxLSS1	NxLSS0	Interlace Setting		
		Non-Interlace	Single-Density Interlace	Double-Density Interlace
0	0	Each line	Every 2 lines	Each line
0	1	Every 2 lines	Every 4 lines	Every 2 lines
1	0	Every 4 lines	Every 8 lines	Every 4 lines
1	1	Every 8 lines	Every 16 lines	Every 8 lines

**Note:** 0 or 1 is entered in bit name for x.

#### Line zoom enable bit: Line zoom X enable bit (N1LZMX, N0LZMX)

Designates whether expansion-reduction is done horizontally in line units.

N0LZMX	18009AH	Bit 3	For NBG0
N1LSCX	18009AH	Bit 11	For NBG1



NxLZMX	Process
0	Does not scale horizontally per line units
1	Scales horizontally per line units

**Note:** 0 or 1 is entered in bit name for x.

**Line scroll enable bit (for the vertical screen scroll value): Line scroll Y enable bit (N1LSCY, N0LSCY)**

Designates whether scroll is performed by vertical line units.

N0LSCY	18009AH	Bit 2	For NBG0
N1LSCY	18009AH	Bit 10	For NBG1

NxLSCY	Process
0	Does not scroll vertically per line units
1	Scrolls vertically per line units

**Note:** 0 or 1 is entered in bit name for x.

**Line scroll enable bit (for the horizontal screen scroll value): Line scroll X enable bit (N1LSCX, N0LSCX)**

Designates whether scroll is performed by horizontal line units.

N0LSCX	18009AH	Bit 1	For NBG0
N1LSCX	18009AH	Bit 9	For NBG1

NxLSCX	Process
0	Does not scroll horizontally per line units
1	Scrolls horizontally per line units

**Note:** 0 or 1 is entered in bit name for x.

**Vertical cell scroll enable bit (N1VCSC, N0VCSC)**

Designates whether to perform vertical cell scroll.

N0VCSC	18009AH	Bit 0	For NBG0
N1VCSC	18009AH	Bit 8	For NBG1

NxVCSC	Process
0	Does not cell-scroll vertically
1	Cell-scrolls vertically

**Note:** 0 or 1 is entered in bit name for x.

• Vertical Cell Scroll Table Address (NBG0, NBG1)

	15	14	13	12	11	10	9	8
VCSTAU	~	~	~	~	~	~	~	~
18009CH	7	6	5	4	3	2	1	0
	~	~	~	~	~	VCSTA18	VCSTA17	VCSTA16

• Vertical Cell Scroll Table Address (NBG0, NBG1)

	15	14	13	12	11	10	9	8
VCSTAL	VCSTA15	VCSTA14	VCSTA13	VCSTA12	VCSTA11	VCSTA10	VCSTA9	VCSTA8
18009EH	7	6	5	4	3	2	1	0
	VCSTA7	VCSTA6	VCSTA5	VCSTA4	VCSTA3	VCSTA2	VCSTA1	~

Vertical cell scroll table address bit (VCSTA18 to VCSTA1),

Designates the lead address of the vertical cell scroll table on the VRAM.

VCSTA18~VCSTA16	18009CH	Bit 2~0	
VCSTA15~VCSTA1	18009EH	Bit 15~1	

• Line Scroll Table Address (NBG0)

	15	14	13	12	11	10	9	8
LSTA0U	~	~	~	~	~	~	~	~
1800A0H	7	6	5	4	3	2	1	0
	~	~	~	~	~	NOLSTA18	NOLSTA17	NOLSTA16

• Line Scroll Table Address (NBG0)

	15	14	13	12	11	10	9	8
LSTA0L	NOLSTA15	NOLSTA14	NOLSTA13	NOLSTA12	NOLSTA11	NOLSTA10	NOLSTA9	NOLSTA8
1800A2H	7	6	5	4	3	2	1	0
	NOLSTA7	NOLSTA6	NOLSTA5	NOLSTA4	NOLSTA3	NOLSTA2	NOLSTA1	~

• Line Scroll Table Address (NBG1)

	15	14	13	12	11	10	9	8
LSTA1U	~	~	~	~	~	~	~	~
1800A4H	7	6	5	4	3	2	1	0
	~	~	~	~	~	N1LSTA18	N1LSTA17	N1LSTA16

• Line Scroll Table Address (NBG1)

	15	14	13	12	11	10	9	8
LSTA1L	N1LSTA15	N1LSTA14	N1LSTA13	N1LSTA12	N1LSTA11	N1LSTA10	N1LSTA9	N1LSTA8
1800A6H	7	6	5	4	3	2	1	0
	N1LSTA7	N1LSTA6	N1LSTA5	N1LSTA4	N1LSTA3	N1LSTA2	N1LSTA1	~



**Line scroll table address bit (N0LSTA18 to N0LSTA16, N0LSTA15 to N0LSTA1, N1LSTA18 to N1LSTA16, N1LSTA15 to N1LSTA1)**

Designates the lead address of the line scroll table on the VRAM.

N0LSTA18~N0LSTA16	1800A0H	Bit 2~0	For NBG0 (upper bit)
N0LSTA15~N0LSTA1	1800A2H	Bit 15~1	For NBG0 (lower bit)
N1LSTA18~N1LSTA16	1800A4H	Bit 2~0	For NBG1 (upper bit)
N1LSTA15~N1LSTA1	1800A6H	Bit 15~1	For NBG1 (lower bit)

• **Line Color Screen Table Address**

	15	14	13	12	11	10	9	8
LCTAU	LCCLMD	~	~	~	~	~	~	~
1800A8H	7	6	5	4	3	2	1	0
	~	~	~	~	~	LCTA18	LCTA17	LCTA16

• **Line Color Screen Table Address**

	15	14	13	12	11	10	9	8
LCTAL	LCTA15	LCTA14	LCTA13	LCTA12	LCTA11	LCTA10	LCTA9	LCTA8
1800AAH	7	6	5	4	3	2	1	0
	LCTA7	LCTA6	LCTA5	LCTA4	LCTA3	LCTA2	LCTA1	LCTA0

**Line color screen mode bit: LNCL color mode bit (LCCLMD), bit 15**

Designates the color mode of the line color screen.

LCCLMD	Line Color Screen Color
0	Single color
1	Select per each line

**Line color screen table address bit: LNCL table address bit (LCTA18 to LCTA0)**

Designates the lead address of the line color screen table on the VRAM.

LCTA18~LCTA16	1800A8H	Bit 2~0	
LCTA15~LCTA0	1800AAH	Bit 15~0	

• **Back Screen Table Address**

	15	14	13	12	11	10	9	8
BKTAU	BKCLMD	~	~	~	~	~	~	~
1800ACH	7	6	5	4	3	2	1	0
	~	~	~	~	~	BKTA18	BKTA17	BKTA16

• **Back Screen Table Address**

	15	14	13	12	11	10	9	8
BKTAL	BKTA15	BKTA14	BKTA13	BKTA12	BKTA11	BKTA10	BKTA9	BKTA8
1800AEH	7	6	5	4	3	2	1	0
	BKTA7	BKTA6	BKTA5	BKTA4	BKTA3	BKTA2	BKTA1	BKTA0

**Back screen color mode bit: BACK color mode bit (BKCLMD), bit 15**

Designates color mode of the back screen.

BKCLMD	Back Screen Color
0	Single color
1	Select per each line

**Back screen table address bit: BACK color table address bit (BKTA18 to BKTA0)**

Designates the lead address of the back screen table on the VRAM.

BKTA18~BKTA16	1800ACH	Bit 2~0	
BKTA 15~BKTA0	1800AEH	Bit 15~0	

• **Rotation Parameter Mode**

	15	14	13	12	11	10	9	8
RPMD	~	~	~	~	~	~	~	~
1800B0H	7	6	5	4	3	2	1	0
	~	~	~	~	~	~	RPMD1	RPMD0

**Rotation parameters mode bit (RPMD1, RPMD0), bits 1 and 0**

When displaying RGB0, designates which rotation parameter of A or B will be used.

RPMD1	RPMD0	Mode	Rotation Parameter
0	0	0	Rotation Parameter A
0	1	1	Rotation Parameter B
1	0	2	A screen and B screen are switched via coefficient data read from rotation parameter A coefficient table.
1	1	3	A screen and B screen are switched via rotation parameter window

• **Rotation Parameter Read Control**

	15	14	13	12	11	10	9	8
RPRCTL	~	~	~	~	~	RBKASTRE	RBYSTRE	RBXSTRE
1800B2H	7	6	5	4	3	2	1	0
	~	~	~	~	~	RAKASTRE	RAYSTRE	RAXSTRE



**Parameter read enable bit (RAXSTRE, RBXSTRE, RAYSTRE, RBYSTRE, RAKASTRE, RBKASTRE)**

Designates the coefficient table start address KAst and TV screen start coordinates Xst and Yst and whether to read from the rotation parameter table in that line.

RAXSTRE	1800B2H	Bit 0	For Xst of Rotation Parameter A
RBXSTRE	1800B2H	Bit 8	For Xst of Rotation Parameter B
RAYSTRE	1800B2H	Bit 1	For Yst of Rotation Parameter A
RBYSTRE	1800B2H	Bit 9	For Yst of Rotation Parameter B
RAKASTRE	1800B2H	Bit 2	For KAst of Rotation Parameter A
RBKASTRE	1800B2H	Bit 10	For KAst of Rotation Parameter B

RxSTRE	Process
0	Selected parameters are not read for that line
1	Selected parameters are read for that line

**Note:** AX, BX, AY, BY, AKA, or BKA is entered in bit name for x.

**• Coefficient Table Control**

	15	14	13	12	11	10	9	8
KTCTL	~	~	~	RBKLCE	RBKMD1	RBKMD0	RBKDBS	RBKTE
1800B4H	7	6	5	4	3	2	1	0
	~	~	~	RAKLCE	RAKMD1	RAKMD0	RAKDBS	RAKTE

**Coefficient line color enable bit (RAKLCE, RBKLCE)**

Designates whether to use line color screen data in coefficient data.

RAKLCE	1800B4H	Bit 4	For Rotation Parameter A
RBKLCE	1800B4H	Bit 12	For Rotation Parameter B

RxKLCE	Process
0	Line color screen data within coefficient data is not used
1	Line color screen data within coefficient data is used

**Note:** A or B is entered in the bit name for x.

**Coefficient data mode bit: Coefficient mode bit (RAKMD1, RAKMD0, RBKMD1, RBKMD0)**

Designates what parameters the coefficient data is used as.

RAKMD1, RAKMD0	1800B4H	Bit 3,2	For Rotation Parameter A
RBKMD1, RBKMD0	1800B4H	Bit 11,10	For Rotation Parameter B

RxKMD1	RxKMD0	Mode	Coefficient Data Function
0	0	0	Use as scale coefficient kx, ky
0	1	1	Use as scale coefficient kx
1	0	2	Use as scale coefficient ky
1	1	3	Use as viewpoint Xp after rotation conversion

**Note:** A or B is entered in the bit name for x.

**Coefficient data size bit (RAKDDBS, RBKDDBS)**

Designates the size of the coefficient data.

RAKDDBS	1800B4H	Bit 1	For Rotation Parameter A
RBKDDBS	1800B4H	Bit 9	For Rotation Parameter B

RxKDDBS	Coefficient Data Size
0	2 Words
1	1 Word

**Note:** A or B is entered in the bit name for x.

**Coefficient table enable bit (RAKTE, RBKTE)**

Designates whether the coefficient table is used.

RAKTE	1800B4H	Bit 0	For Rotation Parameter A
RBKTE	1800B4H	Bit 8	For Rotation Parameter B

RxKTE	Process
0	Do not use coefficient table
1	Use coefficient table

**Note:** A or B is entered in the bit name for x.

• **Coefficient Table Address Offset (Rotation Parameter A, B)**

	15	14	13	12	11	10	9	8
KTAOF	~	~	~	~	~	RBKTAOS2	RBKTAOS1	RBKTAOS0
1800B6H	7	6	5	4	3	2	1	0
	~	~	~	~	~	RAKTAOS2	RAKTAOS1	RAKTAOS0

**Coefficient table address offset bit (RAKTAOS2 to RAKTAOS0, RBKTAOS2 to RBKTAOS0)**

Designates the lead address offset value of the coefficient table stored in the rotation parameter table.





RAKTAOS2~RAKTAOS0	1800B6H	Bit 2~0	For Rotation Parameter A
RBKTAOS2~RBKTAOS0	1800B6H	Bit 10~8	For Rotation Parameter B

• **Screen-over Pattern Name (Rotation Parameter A)**

	15	14	13	12	11	10	9	8
OVPNRA	RAOPN15	RAOPN14	RAOPN13	RAOPN12	RAOPN11	RAOPN10	RAOPN9	RAOPN8
1800B8H	7	6	5	4	3	2	1	0
	RAOPN7	RAOPN6	RAOPN5	RAOPN4	RAOPN3	RAOPN2	RAOPN1	RAOPN0

• **Screen-over Pattern Name (Rotation Parameter B)**

	15	14	13	12	11	10	9	8
OVPNRB	RBOPN15	RBOPN14	RBOPN13	RBOPN12	RBOPN11	RBOPN10	RBOPN9	RBOPN8
1800BAH	7	6	5	4	3	2	1	0
	RBOPN7	RBOPN6	RBOPN5	RBOPN4	RBOPN3	RBOPN2	RBOPN1	RBOPN0

**Over pattern name bit (RAOPN15 to RAOPN0, RBOPN15 to RBOPN0)**

Designates pattern name data when the screen-over process repeating the character pattern is set.

RAOPN15~RAOPN0	1800B8H	Bit 15~0	For Rotation Parameter A
RBOPN15~RBOPN0	1800BAH	Bit 15~0	For Rotation Parameter B

• **Rotation Parameter Table Address (Rotation Parameter A, B)**

	15	14	13	12	11	10	9	8
RPYAU	~	~	~	~	~	~	~	~
1800BCH	7	6	5	4	3	2	1	0
	~	~	~	~	~	RPTA18	RPTA17	RPTA16

• **Rotation Parameter Table Address (Rotation Parameter A, B)**

	15	14	13	12	11	10	9	8
RPTAL	RPTA15	RPTA14	RPTA13	RPTA12	RPTA11	RPTA10	RPTA9	RPTA8
1800BEH	7	6	5	4	3	2	1	0
	RPTA7	RPTA6	RPTA5	RPTA4	RPTA3	RPTA2	RPTA1	~

**Rotation parameters table address bit (RPTA18 to RPTA1)**

Designates the lead address of rotation parameter tables.

RPTA18~RPTA16	1800BCH	Bit 2~0	
RPTA15~RPTA1	1800BEH	Bit 15~1	

• **Window Position (W0, Horizontal Start Point)**

	15	14	13	12	11	10	9	8
WPSX0	~	~	~	~	~	~	W0SX9	W0SX8
1800C0H	7	6	5	4	3	2	1	0
	W0SX7	W0SX6	W0SX5	W0SX4	W0SX3	W0SX2	W0SX1	W0SX0

• **Window Position (W0, Vertical Start Point)**

	15	14	13	12	11	10	9	8
WPSY0	~	~	~	~	~	~	~	W0SY8
1800C2H	7	6	5	4	3	2	1	0
	W0SY7	W0SY6	W0SY5	W0SY4	W0SY3	W0SY2	W0SY1	W0SY0

• **Window Position (W0, Horizontal End Point)**

	15	14	13	12	11	10	9	8
WPEX0	~	~	~	~	~	~	W0EX9	W0EX8
1800C4H	7	6	5	4	3	2	1	0
	W0EX7	W0EX6	W0EX5	W0EX4	W0EX3	W0EX2	W0EX1	W0EX0

• **Window Position (W0, Vertical End Point)**

	15	14	13	12	11	10	9	8
WPEY0	~	~	~	~	~	~	~	W0EY8
1800C6H	7	6	5	4	3	2	1	0
	W0EY7	W0EY6	W0EY5	W0EY4	W0EY3	W0EY2	W0EY1	W0EY0

• **Window Position (W1, Horizontal Start Point)**

	15	14	13	12	11	10	9	8
WPSX1	~	~	~	~	~	~	W1SX9	W1SX8
1800C8H	7	6	5	4	3	2	1	0
	W1SX7	W1SX6	W1SX5	W1SX4	W1SX3	W1SX2	W1SX1	W1SX0

• **Window Position (W1, Vertical Start Point)**

	15	14	13	12	11	10	9	8
WPSY1	~	~	~	~	~	~	~	W1SY8
1800CAH	7	6	5	4	3	2	1	0
	W1SY7	W1SY6	W1SY5	W1SY4	W1SY3	W1SY2	W1SY1	W1SY0

• **Window Position (W1, Horizontal End Point)**

	15	14	13	12	11	10	9	8
WPEX1	~	~	~	~	~	~	W1EX9	W1EX8
1800CCH	7	6	5	4	3	2	1	0
	W1EX7	W1EX6	W1EX5	W1EX4	W1EX3	W1EX2	W1EX1	W1EX0



• **Window Position (W1, Vertical End Point)**

	15	14	13	12	11	10	9	8
WPEY1	~	~	~	~	~	~	~	W1EY8
1800CEH	7	6	5	4	3	2	1	0
	W1EY7	W1EY6	W1EY5	W1EY4	W1EY3	W1EY2	W1EY1	W1EY0

**Window position bit (for horizontal coordinates): Window start/end X bit (W0SX9 to W0SX0, W0EX9 to W0EX0, W1SX9 to W1SX0, W1EX9 to W1EX0)**

Designates the horizontal start and end coordinates. Designated coordinate value is the coordinate value (H counter value) on the TV screen

W0SX9~W0SX0	1800C0H	Bit 9~0	For W0 start point coordinates
W0EX9~W0EX0	1800C4H	Bit 9~0	For W0 end point coordinates
W1SX9~W1SX0	1800C8H	Bit 9~0	For W1 start point coordinates
W1EX9~W1EX0	1800CCH	Bit 9~0	For W1 end point coordinates

Graphics Mode	WxxX9	WxxX8	WxxX7	WxxX6	WxxX5	WxxX4	WxxX3	WxxX2	WxxX1	WxxX0
Normal	H8	H7	H6	H5	H4	H3	H2	H1	H0	Invalid
Hi-Res	H9	H8	H7	H6	H5	H4	H3	H2	H1	H0
Exclusive Normal	Invalid	H8	H7	H6	H5	H4	H3	H2	H1	H0
Exclusive Hi-Res	Invalid	H9	H8	H7	H6	H5	H4	H3	H2	H1

**Note:** 0S, 0E, 1S, or 1E is entered in bit name for xx.

**Window position bit (for vertical coordinates): Window start/end Y bit (W0SY8 to W0SY0, W0EY8 to W0EY0, W1SY8 to W1SY0, W1EY8 to W1EY0)**

Designates the vertical start and end coordinates. The designated coordinate value is the coordinate value (V counter value) on the TV screen.

W0SY8~W0SY0	1800C2H	Bit 8~0	For W0 start point coordinates
W0EY8~W0EY0	1800C6H	Bit 8~0	For W0 end point coordinates
W1SY8~W1SY0	1800CAH	Bit 8~0	For W1 start point coordinates
W1EY8~W1EY0	1800CEH	Bit 8~0	For W1 end point coordinates

TV Screen (Interlace) Mode	WxxY8	WxxY7	WxxY6	WxxY5	WxxY4	WxxY3	WxxY2	WxxY1	WxxY0
Normal, Hi-Res (Non-interlace, Single-Density Interlace)	V8	V7	V6	V5	V4	V3	V2	V1	V0
Normal, Hi-Res (Double-Density Interlace)	V7	V6	V5	V4	V3	V2	V1	V0	Invalid
Exclusive Monitor	V8	V7	V6	V5	V4	V3	V2	V1	V0

**Note:** 0S, 0E, 1S or 1E is entered in bit name for xx.

• **Window Control (NBG0, NBG1)**

	15	14	13	12	11	10	9	8
WCTLA	N1LOG	~	N1SWE	N1SWA	N1W1E	N1W1A	N1W0E	N1W0A
1800D0H	7	6	5	4	3	2	1	0
	N0LOG	~	N0SWE	N0SWA	N0W1E	N0W1A	N0W0E	N0W0A

• **Window Control (NBG2, NBG3)**

	15	14	13	12	11	10	9	8
WCTLB	N3LOG	~	N3SWE	N3SWA	N3W1E	N3W1A	N3W0E	N3W0A
1800D2H	7	6	5	4	3	2	1	0
	N2LOG	~	N2SWE	N2SWA	N2W1E	N2W1A	N2W0E	N2W0A

• **Window Control (RBG0, Sprite)**

	15	14	13	12	11	10	9	8
WCTLC	SPLOG	~	SPSWE	SPSWA	SPW1E	SPW1A	SPW0E	SPW0A
1800D4H	7	6	5	4	3	2	1	0
	R0LOG	~	R0SWE	R0SWA	R0W1E	R0W1A	R0W0E	R0W0A

• **Window Control (Rotation Window, Color Calculation Window)**

	15	14	13	12	11	10	9	8
WCTLD	CCLOG	~	CCSWE	CCSWA	CCW1E	CCW1A	CCW0E	CCW0A
1800D6H	7	6	5	4	3	2	1	0
	RPLOG	~	~	~	RPW1E	RPW1A	RPW0E	RPW0A

**Window logic bit:** Logic bit (N0LOG, N1LOG, N2LOG, N3LOG, R0LOG, SPLOG, RPLOG, CCLOG)

Designates the method of overlapping windows used in each screen.



N0LOG	1800D0H	Bit 7	Transparent Process Window for NBG0 (or RBG1)
N1LOG	1800D0H	Bit 15	Transparent Process Window for NBG1 (or EXBG)
N2LOG	1800D2H	Bit 7	Transparent Process Window for NBG2
N3LOG	1800D2H	Bit 15	Transparent Process Window for NBG3
R0LOG	1800D4H	Bit 7	Transparent Process Window for RBG0
SPLOG	1800D4H	Bit 15	Transparent Process Window for Sprite
RPLOG	1800D6H	Bit 7	For Rotation Parameter Window
CCLOG	1800D6H	Bit 15	For Color Calculation Window

xxLOG	Overlaid Logic
0	OR
1	AND

**Note:** N0, N1, N2, N3, R0, SP, RP or CC is entered in bit name for xx.

**Window enable bit (for W0): W0 enable bit (N0W0E, N1W0E, N2W0E, N3W0E, R0W0E, SPW0E, RPW0E, CCW0E)**

Designates whether to use the Normal window W0 in each screen.

N0W0E	1800D0H	Bit 1	Transparent Process Window for NBG0 (or RBG1)
N1W0E	1800D0H	Bit 9	Transparent Process Window for NBG1 (or EXBG)
N2W0E	1800D2H	Bit 1	Transparent Process Window for NBG2
N3W0E	1800D2H	Bit 9	Transparent Process Window for NBG3
R0W0E	1800D4H	Bit 1	Transparent Process Window for RBG0
SPW0E	1800D4H	Bit 9	Transparent Process Window for Sprite
RPW0E	1800D6H	Bit 1	For Rotation Parameter Window
CCW0E	1800D6H	Bit 9	For Color Calculation Window

xxW0E	Process
0	Does not use W0 window
1	Uses W0 window

**Note:** N0, N1, N2, N3, R0, SP, RP, or CC is entered in bit name for xx.

**Window enable bit (for W1): W1 enable bit (N0W1E, N1W1E, N2W1E, N3W1E, R0W1E, SPW1E, RPW1E, CCW1E)**

Designates whether to use the Normal window W1 in each screen.

N0W1E	1800D0H	Bit 3	Transparent Process Window for NBG0 (or RBG1)
N1W1E	1800D0H	Bit 11	Transparent Process Window for NBG1 (or EXBG)
N2W1E	1800D2H	Bit 3	Transparent Process Window for NBG2
N3W1E	1800D2H	Bit 11	Transparent Process Window for NBG3
R0W1E	1800D4H	Bit 3	Transparent Process Window for RBG0
SPW1E	1800D4H	Bit 11	Transparent Process Window for Sprite
RPW1E	1800D6H	Bit 3	For Rotation Parameter Window
CCW1E	1800D6H	Bit 11	For Color Calculation Window

xxW1E	Process
0	Does not use W1 window
1	Uses W1 window

**Note:** N0, N1, N2, N3, R0, SP, RP, or CC is entered in bit name for xx.

**Window enable bit (for SW): SW enable bit (N0SWE, N1SWE, N2SWE, N3SWE, R0SWE, SPSWE, CCSWE)**

Designates whether to use the sprite window SW in each screen.

N0SWE	1800D0H	Bit 5	Transparent Process Window for NBG0 (or RBG1)
N1SWE	1800D0H	Bit 13	Transparent Process Window for NBG1 (or EXBG)
N2SWE	1800D2H	Bit 5	Transparent Process Window for NBG2
N3SWE	1800D2H	Bit 13	Transparent Process Window for NBG3
R0SWE	1800D4H	Bit 5	Transparent Process Window for RBG0
SPSWE	1800D4H	Bit 13	Transparent Process Window for Sprite
CCSWE	1800D6H	Bit 13	For Color Calculation Window

xxSWE	Process
0	Does not use SW window
1	Uses SW window

**Note:** N0, N1, N2, N3, R0, SP, or CC is entered in bit name for xx.

**Window area bit (for W0): W0 area bit (N0W0A, N1W0A, N2W0A, N3W0A, R0W0A, SPW0A, RPW0A, CCW0A)**

Designates which area is the valid area of the Normal window W0 used in each screen.



N0W0A	1800D0H	Bit 0	Transparent Process Window for NBG0 (or RBG1)
N1W0A	1800D0H	Bit 8	Transparent Process Window for NBG1 (or EXBG)
N2W0A	1800D2H	Bit 0	Transparent Process Window for NBG2
N3W0A	1800D2H	Bit 8	Transparent Process Window for NBG3
R0W0A	1800D4H	Bit 0	Transparent Process Window for RBG0
SPW0A	1800D4H	Bit 8	Transparent Process Window for Sprite
RPW0A	1800D6H	Bit 0	For Rotation Parameter Window
CCW0A	1800D6H	Bit 8	For Color Calculation Window

xxW0A	Process
0	Enables the inside of W0 window
1	Enables the outside of W0 window

**Note:** N0, N1, N2, N3, R0, SP, RP, or CC is entered in bit name for xx.

**Window area bit (for W1): W1 area bit (N0W1A, N1W1A, N2W1A, N3W1A, R0W1A, SPW1A, RPW1A, CCW1A)**

Designates which area is the valid area of the Normal window W1 used in each screen.

N0W1A	1800D0H	Bit 2	Transparent Process Window for NBG0 (or RBG1)
N1W1A	1800D0H	Bit 10	Transparent Process Window for NBG1 (or EXBG)
N2W1A	1800D2H	Bit 2	Transparent Process Window for NBG2
N3W1A	1800D2H	Bit 10	Transparent Process Window for NBG3
R0W1A	1800D4H	Bit 2	Transparent Process Window for RBG0
SPW1A	1800D4H	Bit 10	Transparent Process Window for Sprite
RPW1A	1800D6H	Bit 2	For Rotation Parameter Window
CCW1A	1800D6H	Bit 10	For Color Calculation Window

xxW1A	Process
0	Enables the inside of W1 window
1	Enables the outside of W1 window

**Note:** N0, N1, N2, N3, R0, SP, RP, or CC is entered in bit name for xx.

**Window area bit (for SW): SW area bit (N0SWA, N1SWA, N2SWA, N3SWA, R0SWA, SPSWA, CCSWA)**

Designates which area is the valid area of the sprite window SW used in each screen.

N0SWA	1800D0H	Bit 4	Transparent Process Window for NBG0 (or RBG1)
N1SWA	1800D0H	Bit 12	Transparent Process Window for NBG1 (or EXBG)
N2SWA	1800D2H	Bit 4	Transparent Process Window for NBG2
N3SWA	1800D2H	Bit 12	Transparent Process Window for NBG3
R0SWA	1800D4H	Bit 4	Transparent Process Window for RBG0
SPSWA	1800D4H	Bit 12	Transparent Process Window for Sprite
CCSWA	1800D6H	Bit 12	For Color Calculation Window

xxSWA	Process
0	Enables the inside of SW window
1	Enables the outside of SW window

**Note:** N0, N1, N2, N3, R0, SP or CC is entered in bit name for xx.

### • Line Window Table Address (W0)

	15	14	13	12	11	10	9	8
LWTA0U	W0LWE	~	~	~	~	~	~	~
1800D8H	7	6	5	4	3	2	1	0
	~	~	~	~	~	W0LWTA18	W0LWTA17	W0LWTA16

### • Line Window Table Address (W0)

	15	14	13	12	11	10	9	8
LWTA0L	W0LWTA15	W0LWTA14	W0LWTA13	W0LWTA12	W0LWTA11	W0LWTA10	W0LWTA9	W0LWTA8
1800DAH	7	6	5	4	3	2	1	0
	W0LWTA7	W0LWTA6	W0LWTA5	W0LWTA4	W0LWTA3	W0LWTA2	W0LWTA1	~

### • Line Window Table Address (W1)

	15	14	13	12	11	10	9	8
LWTA1U	W1LWE	~	~	~	~	~	~	~
1800DCH	7	6	5	4	3	2	1	0
	~	~	~	~	~	W1LWTA18	W1LWTA17	W1LWTA16

### • Line Window Table Address (W1)

	15	14	13	12	11	10	9	8
LWTA1L	W1LWTA15	W1LWTA14	W1LWTA13	W1LWTA12	W1LWTA11	W1LWTA10	W1LWTA9	W1LWTA8
1800DEH	7	6	5	4	3	2	1	0
	W1LWTA7	W1LWTA6	W1LWTA5	W1LWTA4	W1LWTA3	W1LWTA2	W1LWTA1	~

### Line window enable bit (W0LWE, W1LWE)

Designates whether to make the Normal window a line window.

W0LWE	1800D8H	Bit 15	For W0
W1LWE	1800DCH	Bit 15	For W1





WxLWE	Process
0	Does not process Normal Window to Line Window
1	Processes Normal Window to Line Window

**Note:** 0 or 1 is entered in bit name for x.

**Line window table address bit (W0LWTA18 to W0LWTA1, W1LWTA18 to W1LWTA1)**

Designates the lead address of the line window table in VRAM.

W0LWTA18~W0LWTA16	1800D8H	Bit 2~0	For W0
W0LWTA15~W0LWTA1	1800DAH	Bit 15~1	For W0
W1LWTA18~W1LWTA16	1800DCH	Bit 2~0	For W1
W1LWTA15~W1LWTA1	1800DEH	Bit 15~1	For W1

**• Sprite Control**

	15	14	13	12	11	10	9	8
SPCTL	~	~	SPCCCS1	SPCCCS0	~	SPCCN2	SPCCN1	SPCCN0
1800E0H	7	6	5	4	3	2	1	0
	~	~	SPCLMD	SPWINEN	SPTYPE3	SPTYPE2	SPTYPE1	SPTYPE0

**Sprite color calculation condition bit (SPCCCS1, SPCCCS0), bits 13, 12**

Designates the color calculation condition of sprites.

SPCCCS1	SPCCCS0	Condition
0	0	(Priority number) ≤ (Color calculation condition number) only
0	1	(Priority number) = (Color calculation condition number) only
1	0	(Priority number) ≥ (Color calculation condition number) only
1	1	Only when Color Data MSB is 1

**Sprite color calculation number bit (SPCCN2 to SPCCN0), bits 10 to 8**

Designates the color calculation condition number of sprites.

This value is ignored when the color calculation condition is set to perform color calculations only if the most significant bit of color data is 1.

**Sprite color mode bit (SPCLMD), bit 5**

Designates the sprite color mode.

SPCLMD	Sprite Color Format Data
0	Sprite data is all in palette format
1	Sprite data is in palette format and RGB format

**Sprite window enable bit: SW enable bit (SPWINEN), bit 4**  
Designates whether to use the sprite window SW.

SPWINEN	Process
0	Does not use sprite window
1	Uses sprite window

**Sprite type bit (STYPE3 to STYPE0), bits 3 to 0**  
Designates the sprite type.

STYPE3	STYPE2	STYPE1	STYPE0	Sprite Data Type
0	0	0	0	Type 0
0	0	0	1	Type 1
0	0	1	0	Type 2
0	0	1	1	Type 3
0	1	0	0	Type 4
0	1	0	1	Type 5
0	1	1	0	Type 6
0	1	1	1	Type 7
1	0	0	0	Type 8
1	0	0	1	Type 9
1	0	1	0	Type A
1	0	1	1	Type B
1	1	0	0	Type C
1	1	0	1	Type D
1	1	1	0	Type E
1	1	1	1	Type F

• **Shadow Control**

	15	14	13	12	11	10	9	8
SDCTL	~	~	~	~	~	~	~	TPSDSL
1800E2H	7	6	5	4	3	2	1	0
	~	~	BKSDEN	R0SDEN	N3SDEN	N2SDEN	N1SDEN	N0SDEN

**Shadow enable bit (N0SDEN, N1SDEN, N2SDEN, N3SDEN, R0SDEN, BKSDEN)**

This bit designates in sprites of the Normal shadow and transparent shadow whether to use the shadow function for the scroll screen and back screen.



N0SDEN	1800E2H	Bit 0	For NBG0 (or RBG1)
N1SDEN	1800E2H	Bit 1	For NBG1 (or EXBG)
N2SDEN	1800E2H	Bit 2	For NBG2
N3SDEN	1800E2H	Bit 3	For NBG3
R0SDEN	1800E2H	Bit 4	For RBG0
BKSDEN	1800E2H	Bit 5	For Back

xxSDEN	Process
0	Does not use shadow function (shadow not added)
1	Uses shadow function (shadow added)

**Note:** N0, N1, N2, N3, R0, or BK is entered in bit name for xx.

**Transparent shadow select bit (TPSDSL), bit 8**

Designates whether to activate the sprite of the transparent shadow.

TPSDSL	Process
0	Disables transparent shadow sprite
1	Enables transparent shadow sprite

**• Color RAM Address Offset (NBG0~NBG3)**

	15	14	13	12	11	10	9	8
CRAOFA	~	N3CAOS2	N3CAOS1	N3CAOS0	~	N2CAOS2	N2CAOS1	N2CAOS0
1800E4H	7	6	5	4	3	2	1	0
	~	N1CAOS2	N1CAOS1	N1CAOS0	~	N0CAOS2	N0CAOS1	N0CAOS0

**• Color RAM Address Offset (RBG0, Sprite)**

	15	14	13	12	11	10	9	8
CRAOFB	~	~	~	~	~	~	~	~
1800E6H	7	6	5	4	3	2	1	0
	~	SPCAOS2	SPCAOS1	SPCAOS0	~	R0CAOS2	R0CAOS1	R0CAOS0

**Color RAM address offset bit (N0CAOS2 to N0CAOS0, N1CAOS2 to N1CAOS0, N2CAOS2 to N2CAOS0, N3CAOS2 to N3CAOS0, R0CAOS2 to R0CAOS0, SPCAOS2 to SPCAOS0)**

Designates color RAM address offset values with respect to the sprite and each scroll screen.

N0CAOS2~N0CAOS0	1800E4H	Bit 2~0	For NBG0 (or RBG1)
N1CAOS2~N1CAOS0	1800E4H	Bit 6~4	For NBG1 (or EXBG)
N2CAOS2~N2CAOS0	1800E4H	Bit 10~8	For NBG2
N3CAOS2~N3CAOS0	1800E4H	Bit 14~12	For NBG3
R0CAOS2~R0CAOS0	1800E6H	Bit 2~0	For RBG0
SPCAOS2~SPCAOS0	1800E6H	Bit 6~4	For Sprite

### • Line Color Screen Enable

	15	14	13	12	11	10	9	8
LNCLNEN	~	~	~	~	~	~	~	~
1800E8H	7	6	5	4	3	2	1	0
	~	~	SPLCEN	R0LCEN	N3LCEN	N2LCEN	N1LCEN	N0LCEN

#### Line color enable bit (N0LCEN, N1LCEN, N2LCEN, N3LCEN, R0LCEN, SPLCEN)

Designates whether to insert the line color screen when each screen is a top image.

N0LCEN	1800E8H	Bit 0	For NBG0 (or RBG1)
N1LCEN	1800E8H	Bit 1	For NBG1 (or EXBG)
N2LCEN	1800E8H	Bit 2	For NBG2
N3LCEN	1800E8H	Bit 3	For NBG3
R0LCEN	1800E8H	Bit 4	For RBG0
SPLCEN	1800E8H	Bit 5	For Sprite

xxLCEN	Process
0	Does not insert the line color screen when corresponding screen is top image
1	Inserts the line color screen when corresponding screen is top image

**Note:** N0, N1, N2, N3, R0, or SP is entered in the bit name for xx.

### • Special Priority Mode

	15	14	13	12	11	10	9	8
SFPRMD	~	~	~	~	~	~	R0SPRM1	R0SPRM0
1800EAH	7	6	5	4	3	2	1	0
	N3SPRM1	N3SPRM0	N2SPRM1	N2SPRM0	N1SPRM1	N1SPRM0	N0SPRM1	N0SPRM0

#### Special priority mode bit (N0SPRM1, N0SPRM0, N1SPRM1, N1SPRM0, N2SPRM1, N2SPRM0, N3SPRM1, N3SPRM0, R0SPRM1, R0SPRM0)

Designates the special priority function mode of each screen scroll.



N0SPRM1, N0SPRM0	1800EAH	Bit 1,0	For NBG0 (or RBG1)
N1SPRM1, N1SPRM0	1800EAH	Bit 3,2	For NBG1 (or EXBG)
N2SPRM1, N2SPRM0	1800EAH	Bit 5,4	For NBG2
N3SPRM1, N3SPRM0	1800EAH	Bit 7,6	For NBG3
R0SPRM1, R0SPRM0	1800EAH	Bit 9,8	For RBG0

xxSPRM1	xxSPRM0	Mode	Process
0	0	Mode 0	Select the priority number LSB per each screen
0	1	Mode 1	Select the priority number LSB per each character
1	0	Mode 2	Select the priority number LSB per each dot
1	1	-	Selection not allowed

**Note:** N0, N1, N2, N3, or R0 is entered in bit name for xx.

#### • Color Calculation Control

	15	14	13	12	11	10	9	8
CCCTL	BOKEN	BOKN2	BOKN1	BOKN0	~	EXCCEN	CCRTMD	CCMD
1800ECH	7	6	5	4	3	2	1	0
	~	SPCCEN	LCCEN	ROCCEN	N3CCEN	N2CCEN	N1CCEN	N0CCEN

#### Gradation enable bit (BOKEN), bit 15

Designates whether to use the gradation function.

BOKEN	Process
0	Do not use gradation calculation function
1	Use gradation calculation function

#### Gradation screen number bit: Gradation number bit (BOKN2 to BOKN0), bits 14 to 12

Designates the screen using the gradation (shading) calculation function

BOKN2	BOKN1	BOKN0	Screen Using Gradation Calculation Function
0	0	0	Sprite
0	0	1	RBG0
0	1	0	NBG0 or RBG1
0	1	1	Invalid
1	0	0	NBG1 or EXBG
1	0	1	NBG2
1	1	0	NBG3
1	1	1	Invalid

**Extended color calculation enable bit (EXCCEN), bit 10**

Designates whether to use the extended color calculation function

EXCCEN	Process
0	Do not use extended color calculation
1	Use extended color calculation

**Color calculation ratio mode bit (CCRTMD), bit 9**

Designates the color calculation ratio mode.

CCRTMD	Mode	Process
0	0	For color calculation ratio, select per top screen side
1	1	For color calculation ratio, select per second screen side

**Color calculation mode bit (CCMD), bit 8**

Designates the color calculation mode.

CCMD	Mode	Process
0	0	Add according to the color calculation register value
1	1	Add as is

**Color calculation enable bit (N0CCEN, N1CCEN, N2CCEN, N3CCEN, R0CCEN, LCCEN, SPCCEN)**

Designates whether to perform color calculation (color calculation enable)

N0CCEN	1800ECH	Bit 0	For NBG0 (or RBG1)
N1CCEN	1800ECH	Bit 1	For NBG1 (or EXBG)
N2CCEN	1800ECH	Bit 2	For NBG2
N3CCEN	1800ECH	Bit 3	For NBG3
R0CCEN	1800ECH	Bit 4	For RBG0
LCCEN	1800ECH	Bit 5	For LNCL
SPCCEN	1800ECH	Bit 6	For Sprite

xxCCEN	Process
0	Does not color-calculate
1	Color-calculates

**Note :** N0, N1, N2, N3, R0, LC, or SP is entered in bit name for xx.

• **Special Color Calculation Mode**

	15	14	13	12	11	10	9	8
SFCCMD	~	~	~	~	~	~	R0SCCM1	R0SCCM0
1800EEH	7	6	5	4	3	2	1	0
	N3SCCM1	N3SCCM0	N2SCCM1	N2SCCM0	N1SCCM1	N1SCCM0	N0SCCM1	N0SCCM0

**Special color calculation mode bit (N0SCCM1, N0SCCM0, N1SCCM1, N1SCCM0, N2SCCM1, N2SCCM0, N3SCCM1, N3SCCM0, R0SCCM1, R0SCCM0)**

Designates the special color calculation function mode of each scroll screen.

N0SCCM1, N0SCCM0	1800EEH	Bit 1,0	For NBG0 (or RBG1)
N1SCCM1, N1SCCM0	1800EEH	Bit 3,2	For NBG1 (or EXBG)
N2SCCM1, N2SCCM0	1800EEH	Bit 5,4	For NBG2
N3SCCM1, N3SCCM0	1800EEH	Bit 7,6	For NBG3
R0SCCM1, R0SCCM0	1800EEH	Bit 9,8	For RBG0

xxSCCM1	xxSCCM0	Mode	Process
0	0	0	Select color calculation enable per screen
0	1	1	Select color calculation enable per character
1	0	2	Select color calculation enable per dot
1	1	3	Select color calculation enable with color data MSB

**Note:** N0, N1, N2, N3, or R0 is entered in bit name for xx.

• **Priority Number (Sprite 0, 1)**

	15	14	13	12	11	10	9	8
PRISA	~	~	~	~	~	S1PRIN2	S1PRIN1	S1PRIN0
1800F0H	7	6	5	4	3	2	1	0
	~	~	~	~	~	S0PRIN2	S0PRIN1	S0PRIN0

• **Priority Number (Sprite 2, 3)**

	15	14	13	12	11	10	9	8
PRISB	~	~	~	~	~	S3PRIN2	S3PRIN1	S3PRIN0
1800F2H	7	6	5	4	3	2	1	0
	~	~	~	~	~	S2PRIN2	S2PRIN1	S2PRIN0

• **Priority Number (Sprite 4, 5)**

	15	14	13	12	11	10	9	8
PRISC	~	~	~	~	~	S5PRIN2	S5PRIN1	S5PRIN0
1800F4H	7	6	5	4	3	2	1	0
	~	~	~	~	~	S4PRIN2	S4PRIN1	S4PRIN0

• **Priority Number (Sprite 6, 7)**

	15	14	13	12	11	10	9	8
PRISD	~	~	~	~	~	S7PRIN2	S7PRIN1	S7PRIN0
1800F6H	7	6	5	4	3	2	1	0
	~	~	~	~	~	S6PRIN2	S6PRIN1	S6PRIN0

**Sprite priority number bit (for sprite) (S0PRIN2 to S0PRIN0, S1PRIN2 to S1PRIN0, S2PRIN2 to S2PRIN0, S3PRIN2 to S3PRIN0, S4PRIN2 to S4PRIN0, S5PRIN2 to S5PRIN0, S6PRIN2 to S6PRIN0, S7PRIN2 to S7PRIN0)**

Designates the sprite priority number.

S0PRIN2~S0PRIN0	1800F0H	Bit 2~0	For Sprite Register 0
S1PRIN2~S1PRIN0	1800F0H	Bit 10~8	For Sprite Register 1
S2PRIN2~S2PRIN0	1800F2H	Bit 2~0	For Sprite Register 2
S3PRIN2~S3PRIN0	1800F2H	Bit 10~8	For Sprite Register 3
S4PRIN2~S4PRIN0	1800F4H	Bit 2~0	For Sprite Register 4
S5PRIN2~S5PRIN0	1800F4H	Bit 10~8	For Sprite Register 5
S6PRIN2~S6PRIN0	1800F6H	Bit 2~0	For Sprite Register 6
S7PRIN2~S7PRIN0	1800F6H	Bit 10~8	For Sprite Register 7

• **Priority Number (NBG0, NBG1)**

	15	14	13	12	11	10	9	8
PRINA	~	~	~	~	~	N1PRIN2	N1PRIN1	N1PRIN0
1800F8H	7	6	5	4	3	2	1	0
	~	~	~	~	~	N0PRIN2	N0PRIN1	N0PRIN0

• **Priority Number (NBG2, NBG3)**

	15	14	13	12	11	10	9	8
PRINB	~	~	~	~	~	N3PRIN2	N3PRIN1	N3PRIN0
1800FAH	7	6	5	4	3	2	1	0
	~	~	~	~	~	N2PRIN2	N2PRIN1	N2PRIN0

• **Priority Number (RBG0)**

	15	14	13	12	11	10	9	8
PRIR	~	~	~	~	~	~	~	~
1800FCH	7	6	5	4	3	2	1	0
	~	~	~	~	~	R0PRIN2	R0PRIN1	R0PRIN0

**Priority number bit (for scroll screen) (N0PRIN2 to N0PRIN0, N1PRIN2 to N1PRIN0, N2PRIN2 to N2PRIN0, N3PRIN2 to N3PRIN0, R0PRIN2 to R0PRIN0)**

Designates the priority number of each screen scroll.





N0PRIN2~N0PRIN0	1800F8H	Bit 2~0	For NBG0 (or RBG1)
N1PRIN2~N1PRIN0	1800F8H	Bit 10~8	For NBG1 (or EXBG)
N2PRIN2~N2PRIN0	1800FAH	Bit 2~0	For NBG2
N3PRIN2~N3PRIN0	1800FAH	Bit 10~8	For NBG3
R0PRIN2~R0PRIN0	1800FCH	Bit 2~0	For RBG0

• Reserve

	15	14	13	12	11	10	9	8
1800FEH	~	~	~	~	~	~	~	~
	7	6	5	4	3	2	1	0
	~	~	~	~	~	~	~	~

• Color Calculation Ratio (Sprite 0, 1)

	15	14	13	12	11	10	9	8
CCRSA	~	~	~	S1CCRT4	S1CCRT3	S1CCRT2	S1CCRT1	S1CCRT0
180100H	7	6	5	4	3	2	1	0
	~	~	~	S0CCRT4	S0CCRT3	S0CCRT2	S0CCRT1	S0CCRT0

• Color Calculation Ratio (Sprite 2, 3)

	15	14	13	12	11	10	9	8
CCRSB	~	~	~	S3CCRT4	S3CCRT3	S3CCRT2	S3CCRT1	S3CCRT0
180102H	7	6	5	4	3	2	1	0
	~	~	~	S2CCRT4	S2CCRT3	S2CCRT2	S2CCRT1	S2CCRT0

• Color Calculation Ratio (Sprite 4, 5)

	15	14	13	12	11	10	9	8
CCRSC	~	~	~	S5CCRT4	S5CCRT3	S5CCRT2	S5CCRT1	S5CCRT0
180104H	7	6	5	4	3	2	1	0
	~	~	~	S4CCRT4	S4CCRT3	S4CCRT2	S4CCRT1	S4CCRT0

• Color Calculation Ratio (Sprite 6, 7)

	15	14	13	12	11	10	9	8
CCRSB	~	~	~	S7CCRT4	S7CCRT3	S7CCRT2	S7CCRT1	S7CCRT0
180106H	7	6	5	4	3	2	1	0
	~	~	~	S6CCRT4	S6CCRT3	S6CCRT2	S6CCRT1	S6CCRT0

Sprite color calculation ratio bit (S0CCRT4 to S0CCRT0, S1CCRT4 to S1CCRT0, S2CCRT4 to S2CCRT0, S3CCRT4 to S3CCRT0, S4CCRT4 to S4CCRT0, S5CCRT4 to S5CCRT0, S6CCRT4 to S6CCRT0, S7CCRT4 to S7CCRT0)

Designates the sprite color calculation ratio. The color calculation ratio is for a value 1/32 of RGB various color data.

S0CCRT4~S0CCRT0	180100H	Bit 4~0	For Sprite Register 0
S1CCRT4~S1CCRT0	180100H	Bit 12~8	For Sprite Register 1
S2CCRT4~S2CCRT0	180102H	Bit 4~0	For Sprite Register 2
S3CCRT4~S3CCRT0	180102H	Bit 12~8	For Sprite Register 3
S4CCRT4~S4CCRT0	180104H	Bit 4~0	For Sprite Register 4
S5CCRT4~S5CCRT0	180104H	Bit 12~8	For Sprite Register 5
S6CCRT4~S6CCRT0	180106H	Bit 4~0	For Sprite Register 6
S7CCRT4~S7CCRT0	180106H	Bit 12~8	For Sprite Register 7

• **Color Calculation Ratio (NBG0, NBG1)**

	15	14	13	12	11	10	9	8
CCRNA	~	~	~	N1CCRT4	N1CCRT3	N1CCRT2	N1CCRT1	N1CCRT0
180108H	7	6	5	4	3	2	1	0
	~	~	~	N0CCRT4	N0CCRT3	N0CCRT2	N0CCRT1	N0CCRT0

• **Color Calculation Ratio (NBG2, NBG3)**

	15	14	13	12	11	10	9	8
CCRNb	~	~	~	N3CCRT4	N3CCRT3	N3CCRT2	N3CCRT1	N3CCRT0
18010AH	7	6	5	4	3	2	1	0
	~	~	~	N2CCRT4	N2CCRT3	N2CCRT2	N2CCRT1	N2CCRT0

• **Color Calculation Ratio (RBG0)**

	15	14	13	12	11	10	9	8
CCRR	~	~	~	~	~	~	~	~
18010CH	7	6	5	4	3	2	1	0
	~	~	~	R0CCRT4	R0CCRT3	R0CCRT2	R0CCRT1	R0CCRT0

• **Color Calculation Ratio (Line Color Screen, Back Screen)**

	15	14	13	12	11	10	9	8
CCRLB	~	~	~	BKCCRT4	BKCCRT3	BKCCRT2	BKCCRT1	BKCCRT0
18010EH	7	6	5	4	3	2	1	0
	~	~	~	LCCRT4	LCCRT3	LCCRT2	LCCRT1	LCCRT0

**Color calculation ratio bit (for scroll screens): (N0CCRT4 to N0CCRT0, N1CCRT4 to N1CCRT0, N2CCRT4 to N2CCRT0, N3CCRT4 to N3CCRT0, R0CCRT4 to R0CCRT0, LCCRT4 to LCCRT0, BKCCRT4 to BKCCRT0)**

Designates the color calculation ratio of each scroll screen. The color calculation ratio corresponds to a value 1/32 times R,G,B color data.



N0CCRT4~N0CCRT0	180108H	Bit 4~0	For NBG0 (or RBG1)
N1CCRT4~N1CCRT0	180108H	Bit 12~8	For NBG1 (or EXBG)
N2CCRT4~N2CCRT0	18010AH	Bit 4~0	For NBG2
N3CCRT4~N3CCRT0	18010AH	Bit 12~8	For NBG3
R0CCRT4~R0CCRT0	18010CH	Bit 4~0	For RBG0
LCCRT4~LCCRT0	18010EH	Bit 4~0	For LNCL
BKCCRT4~BKCCRT0	18010EH	Bit 12~8	For Back

xxCCRT4	xxCCRT3	xxCCRT2	xxCCRT1	xxCCRT0	Color Calculation Ratio Top Image : Second Image
0	0	0	0	0	31:1
0	0	0	0	1	30:2
0	0	0	1	0	29:3
0	0	0	1	1	28:4
0	0	1	0	0	27:5
0	0	1	0	1	26:6
0	0	1	1	0	25:7
0	0	1	1	1	24:8
0	1	0	0	0	23:9
0	1	0	0	1	22:10
0	1	0	1	0	21:11
0	1	0	1	1	20:12
0	1	1	0	0	19:13
0	1	1	0	1	18:14
0	1	1	1	0	17:15
0	1	1	1	1	16:16
1	0	0	0	0	15:17
1	0	0	0	1	14:18
1	0	0	1	0	13:19
1	0	0	1	1	12:20
1	0	1	0	0	11:21
1	0	1	0	1	10:22
1	0	1	1	0	9:23
1	0	1	1	1	8:24
1	1	0	0	0	7:25
1	1	0	0	1	6:26
1	1	0	1	0	5:27
1	1	0	1	1	4:28
1	1	1	0	0	3:29
1	1	1	0	1	2:30
1	1	1	1	0	1:31
1	1	1	1	1	0:32

**Note:** N0, N1, N2, N3, R0, LC, or BK is entered in bit name for xx.

### • Color Offset Enable

	15	14	13	12	11	10	9	8
CLOFEN	~	~	~	~	~	~	~	~
180110H	7	6	5	4	3	2	1	0
	~	SPCOEN	BKCOEN	R0COEN	N3COEN	N2COEN	N1COEN	N0COEN

#### Color offset enable bit (N0COEN, N1COEN, N2COEN, N3COEN, R0COEN, BKCOEN, SPCOEN)

Designates whether to use the color offset function.

N0COEN	180110H	Bit 0	For NBG0 (or RBG1)
N1COEN	180110H	Bit 1	For NBG1 (or EXBG)
N2COEN	180110H	Bit 2	For NBG2
N3COEN	180110H	Bit 3	For NBG3
R0COEN	180110H	Bit 4	For RBG0
BKCOEN	180110H	Bit 5	For Back
SPCOEN	180110H	Bit 6	For Sprite

xxCOEN	Process
0	Do not use color offset function
1	Use color offset function

**Note:** N0, N1, N2, N3, R0, BK, or SP is entered in bit name for xx.

### • Color Offset Select

	15	14	13	12	11	10	9	8
CLOFSL	~	~	~	~	~	~	~	~
180112H	7	6	5	4	3	2	1	0
	~	SPCOSL	BKCOSL	R0COSL	N3COSL	N2COSL	N1COSL	N0COSL

#### Color offset select bit (N0COSL, N1COSL, N2COSL, N3COSL, R0COSL, BKCOSL, SPCOSL)

Designates the color offset register to use when using the color offset function.



N0COSL	180112H	Bit 0	For NBG0 (or RBG1)
N1COSL	180112H	Bit 1	For NBG1 (or EXBG)
N2COSL	180112H	Bit 2	For NBG2
N3COSL	180112H	Bit 3	For NBG3
R0COSL	180112H	Bit 4	For RBG0
BKCOSL	180112H	Bit 5	For Back
SPCOSL	180112H	Bit 6	For Sprite

xxCOSL	Process
0	Use color offset A value
1	Use color offset B value

**Note:** N0, N1, N2, N3, R0, BK, or SP is entered in bit name for xx.

• **Color Offset A (RED)**

	15	14	13	12	11	10	9	8
COAR	~	~	~	~	~	~	~	COARD8
180114H	7	6	5	4	3	2	1	0
	COARD7	COARD6	COARD5	COARD4	COARD3	COARD2	COARD1	COARD0

• **Color Offset A (GREEN)**

	15	14	13	12	11	10	9	8
COAG	~	~	~	~	~	~	~	COAGR8
180116H	7	6	5	4	3	2	1	0
	COAGR7	COAGR6	COAGR5	COAGR4	COAGR3	COAGR2	COAGR1	COAGR0

• **Color Offset A (BLUE)**

	15	14	13	12	11	10	9	8
COAB	~	~	~	~	~	~	~	COABL8
180118H	7	6	5	4	3	2	1	0
	COABL7	COABL6	COABL5	COABL4	COABL3	COABL2	COABL1	COABL0

• **Color Offset B (RED)**

	15	14	13	12	11	10	9	8
COBR	~	~	~	~	~	~	~	COBRD8
18011AH	7	6	5	4	3	2	1	0
	COBRD7	COBRD6	COBRD5	COBRD4	COBRD3	COBRD2	COBRD1	COBRD0

• **Color Offset B (GREEN)**

	15	14	13	12	11	10	9	8
COBG	~	~	~	~	~	~	~	COBGR8
18011CH	7	6	5	4	3	2	1	0
	COBGR7	COBGR6	COBGR5	COBGR4	COBGR3	COBGR2	COBGR1	COBGR0

• Color Offset B (BLUE)

	15	14	13	12	11	10	9	8
COBB	~	~	~	~	~	~	~	COBBL8
18011EH	7	6	5	4	3	2	1	0
	COBBL7	COBBL6	COBBL5	COBBL4	COBBL3	COBBL2	COBBL1	COBBL0

**Color offset value bit: Color offset data bit (COARD8 to COARD0, COAGR8 to COAGR0, COABL8 to COABL0, COBRD8 to COBRD0, COBGR8 to COBGR0, COBBL8 to COBBL0)**

Sets the RGB individual value of color offset A and color offset B. Negative numbers should be set by two complements.

COARD8~COARD0	180114H	Bit 8~0	For color offset A RED data
COAGR8~COAGR0	180116H	Bit 8~0	For color offset A GREEN data
COABL8~COABL0	180118H	Bit 8~0	For color offset A BLUE data
COBRD8~COBRD0	18011AH	Bit 8~0	For color offset B RED data
COBGR8~COBGR0	18011CH	Bit 8~0	For color offset B GREEN data
COBBL8~COBBL0	18011EH	Bit 8~0	For color offset B BLUE data



## 16.4 Table List

The following tables are shown in the table list:

- (1) Character Pattern Tables
- (2) Pattern Name Tables
- (3) Bitmap Pattern Tables
- (4) Line Scroll Tables
- (5) Vertical Cell Scroll Tables
- (6) Rotation Parameter Tables
- (7) Coefficient Tables
- (8) Line Color Screen Tables
- (9) Back Screen Tables
- (10) Normal Line Window Tables

• Character Pattern Table Data Specifications

Bit Count for 1 Dot	Cell Data	Boundary
4 bits/dot	32 bytes/cell	20H byte
8 bits/dot	64 bytes/cell	20H byte
16 bits/dot	128 bytes/cell	20H byte
32 bits/dot	256 bytes/cell	20H byte

• Character Pattern Table

(1) 4 bits/dot (32 bytes/cell)

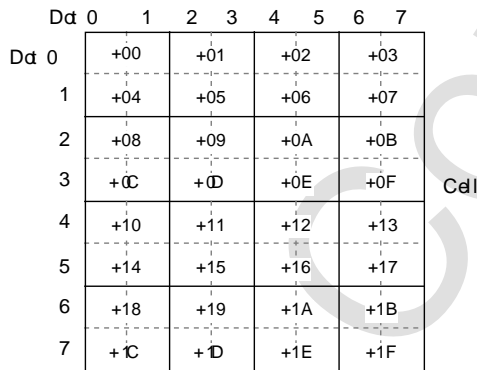
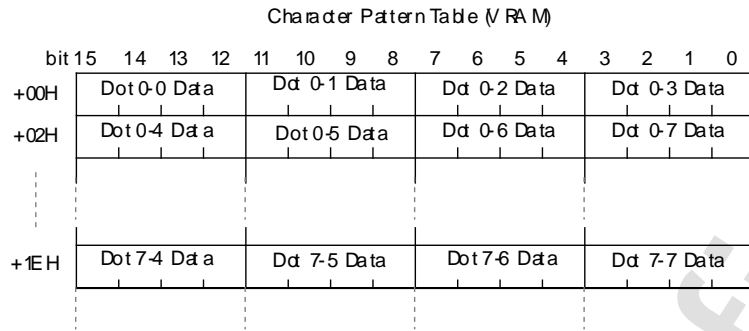

- Note 1: The upper left notation in the cell is dd 0-0 to the right are dd 0-1, dot 0-2, dd 0-3 ...
- Note 2: Numbers in the cells are VRAM addresses (Hexadecimal) of dot (2 dots) data with VRAM address of dd 0-0, 0-1 data as the reference.





• Character Pattern Table (Continued)

(2) 8 bits/dot (64 bytes/cell)

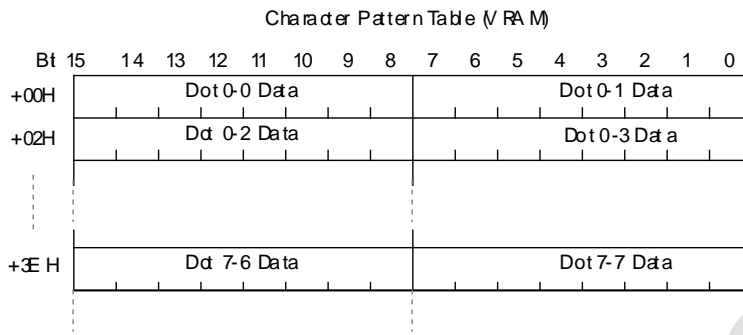

↓

	Dot 0	1	2	3	4	5	6	7	
Dot 0	+00	+01	+02	+03	+04	+05	+06	+07	
1	+08	+09	+0A	+0B	+0C	+0D	+0E	+0F	
2	+10	+11	+12	+13	+14	+15	+16	+17	
3	+18	+19	+1A	+1B	+1C	+1D	+1E	+1F	Cell
4	+20	+21	+22	+23	+24	+25	+26	+27	
5	+28	+29	+2A	+2B	+2C	+2D	+2E	+2F	
6	+30	+31	+32	+33	+34	+35	+36	+37	
7	+38	+39	+3A	+3B	+3C	+3D	+3E	+3F	

Note 1: The upper left notation in the cell is dot 0-0, to the right are dot 0-1, dot 0-2, dot 0-3 ...

Note 2: Numbers in the cells are VRAM addresses (Hexadecimal) of dot data, with VRAM address of dot 0-0 data as the reference.

## • Character Pattern Table (Continued)

(3) 16 bits/dot (128 bytes/cell)

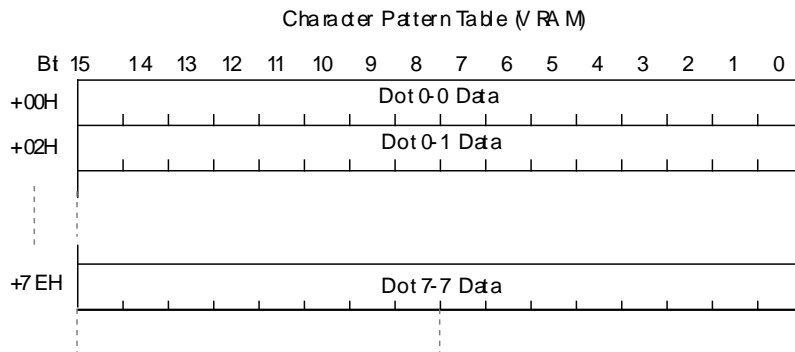

↓

Dot	0	1	2	3	4	5	6	7	
Dot 0	+00	+02	+04	+06	+08	+0A	+0C	+0E	Cell
1	+10	+12	+14	+16	+18	+1A	+1C	+1E	
2	+20	+22	+24	+26	+28	+2A	+2C	+2E	
3	+30	+32	+34	+36	+38	+3A	+3C	+3E	
4	+40	+42	+44	+46	+48	+4A	+4C	+4E	
5	+50	+52	+54	+56	+58	+5A	+5C	+5E	
6	+60	+62	+64	+66	+68	+6A	+6C	+6E	
7	+70	+72	+74	+76	+78	+7A	+7C	+7E	

Note 1: The upper left notation in the cell is dot 0-0; to the right are dot 0-1, dot 0-2, dot 0-3, ...

Note 2: Numbers in the cells are VRAM addresses (Hexadecimal) of dot data, with VRAM address of dot 0-0 data as the reference.

## • Vertical Cell Scroll Table Data Bit Configuration

Vertical Screen Scroll Value

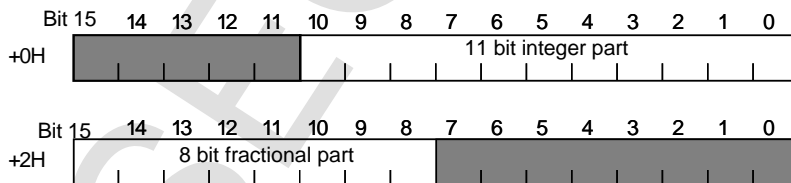

Note: Shaded area is ignored



• Character Pattern Table (Continued)

(4) 32 bits/dot (256 bytes/cell)

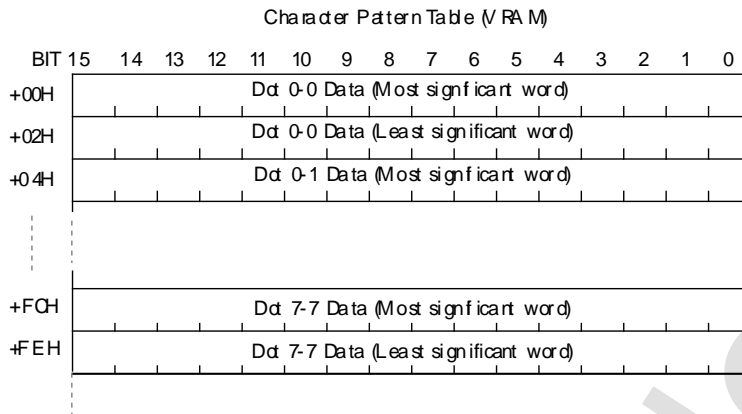

	Dot0	1	2	3	4	5	6	7	
Dot 0	+00	+04	+08	+0C	+10	+14	+18	+1C	
1	+20	+24	+28	+2C	+30	+34	+38	+3C	
2	+40	+44	+48	+4C	+50	+54	+58	+5C	
3	+60	+64	+68	+6C	+70	+74	+78	+7C	Cell
4	+80	+84	+88	+8C	+90	+94	+98	+9C	
5	+A0	+A4	+A8	+AC	+B0	+B4	+B8	+BC	
6	+C0	+C4	+C8	+CC	+D0	+D4	+D8	+DC	
7	+E0	+E4	+E8	+EC	+F0	+F4	+F8	+FC	

Note 1: The upper left notation in the cell is dot 0-0, to the right are dot 0-1, dot 0-2, dot 0-3 ...

Note 2: Numbers in the cells are VRAM addresses (Hexadecimal) of dot data (MSW), with VRAM address of dot 0-0 data (MSW) as the reference.

• **Pattern Name Table Data Specifications**

Pattern Name Data Size	Character Size	Contents of 1 Page	Boundary During VRAM Storage
1 Word	1 H Cell X 1 V Cell	8192 Bytes	2000H
	2 H Cells X 2 V Cells	2048 Bytes	800H
2 Words	1 H Cell X 1 V Cell	16,384 Bytes	4000H
	2 H Cells X 2 V Cells	4096 Bytes	1000H

• **Pattern Name Table**

- (1) Pattern Name Data Size : 1 word  
 Character Pattern Size : 1 H cell X 1 V cell

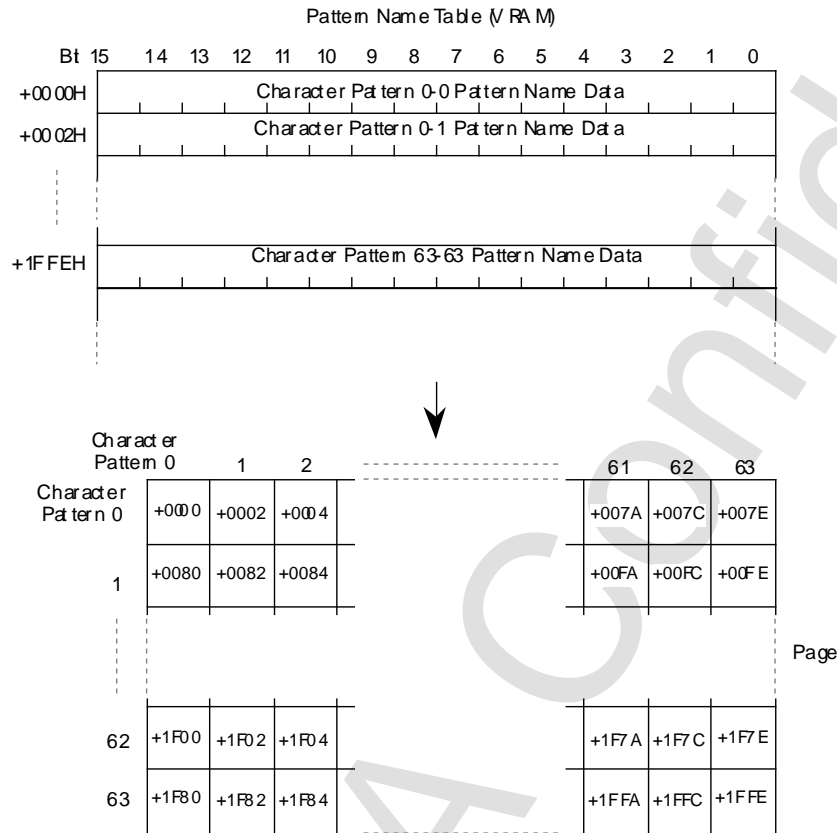

- Note 1: The upper-left notation in the page is character pattern 0-0, to the right are character patterns 0-1, 0-2, 0-3, ...
- Note 2: Numbers in the pages are VRAM addresses (Hexadecimal) of pattern name data of character patterns, with VRAM address of character pattern 0-0 pattern name data as the reference.



• **Pattern Name Table (Continued)**

- (2) Pattern Name Data Size : 1 word  
Character Pattern Size : 2 H cells X 2 V cells

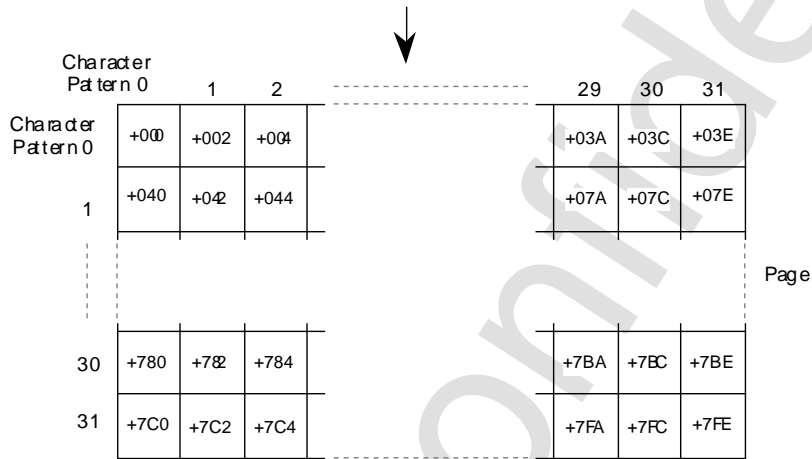
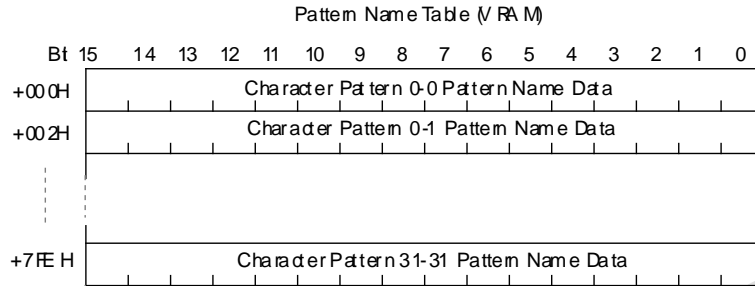

- Note 1: The upper-left notation in the page is character pattern 0-0, to the right are character patterns 0-1, 0-2, 0-3, ...
- Note 2: Numbers in the pages are VRAM addresses (Hexadecimal) of pattern name data of character patterns, with VRAM address of character pattern 0-0 pattern name data as the reference.

SEGA

## • Pattern Name Table (Continued)

(3) Pattern Name Data Size : 2 words  
 Character Pattern Size : 1 H cell X 1 V cell

Pattern Name Table (VRAM)

Bt	15	14	13	12	11	10	9	8	7	6	5	4	3	2	1	0
+0000H	Character Pattern 0-0 Pattern Name Data (Most significant word)															
+0002H	Character Pattern 0-0 Pattern Name Data (Least significant word)															
+0004H	Character Pattern 0-1 Pattern Name Data (Most significant word)															
⋮	⋮															
+3FFCH	Character Pattern 63-63 Pattern Name Data (Most significant word)															
+3FFE H	Character Pattern 63-63 Pattern Name Data (Least significant word)															

↓

Character Pattern	0	1	2	⋮	61	62	63
0	+0000 +0002	+0004 +0006	+0008 +000A	⋮	+00F4 +00F6	+00F8 +00FA	+00FC +00FE
1	+0100 +0102	+0104 +0106	+0108 +010A	⋮	+01F4 +01F6	+01F8 +01FA	+01FC +01FE
⋮	⋮	⋮	⋮	⋮	⋮	⋮	⋮
62	+3E00 +3E02	+3E04 +3E06	+3E08 +3E0A	⋮	+3EF4 +3EF6	+3EF8 +3EFA	+3EFC +3EFE
63	+3F00 +3F02	+3F04 +3F06	+3F08 +3F0A	⋮	+3FF4 +3FF6	+3FF8 +3FFA	+3FFC +3FFE

Page

- Note 1: The upper-left notation in the page is character pattern 0-0, to the right are character patterns 0-1, 0-2, 0-3, ...
- Note 2: Numbers in the pages are VRAM addresses (Hexadecimal) of pattern name data of character patterns, with VRAM address of character pattern 0-0 pattern name data as the reference.



• **Pattern Name Table (Continued)**

- (4) Pattern Name Data Size : 2 words  
Character Pattern Size : 2 H cells X 2 V cells

Pattern Name Table (V RAM)

Bit 15	14	13	12	11	10	9	8	7	6	5	4	3	2	1	0
+000H	Character Pattern 0-0 Pattern Name Data (Most significant word)														
+002H	Character Pattern 0-0 Pattern Name Data (Least significant word)														
+004H	Character Pattern 0-1 Pattern Name Data (Most significant word)														
⋮															
+FFCH	Character Pattern 31-31 Pattern Name Data (Most significant word)														
+FFEH	Character Pattern 31-31 Pattern Name Data (Least significant word)														

↓

Character Pattern 0	1	2	⋮	29	30	31
Character Pattern 0	+000 +002	+004 +006	+008 +00A	⋮	+074 +076	+078 +07A +07C +07E
1	+080 +082	+084 +086	+088 +08A	⋮	+0F4 +0F6	+0F8 +0FA +0FC +0FE
⋮						Page
30	+F00 +F02	+F04 +F06	+F08 +F0A	⋮	+F74 +F76	+F78 +F7A +F7C +F7E
31	+F80 +F82	+F84 +F86	+F88 +F8A	⋮	+FF4 +FF6	+FF8 +FFA +FFC +FFE

- Note 1: The upper-left notation in the page is character pattern 0-0, to the right are character patterns 0-1, 0-2, 0-3, ...
- Note 2: Numbers in the pages are VRAM addresses (Hexadecimal) of pattern name data of character patterns, with VRAM address of character pattern 0-0 pattern name data as the reference.

• **Bitmap Pattern Data Specifications**

Bitmap Size	Bitmap Pattern Data Size	Bitmap Color Count	Size per Surface
512 H dots X 256 V dots	4 bits/dot	16 colors	64K bytes (512K bits)
	8 bits/dot	256 colors	128K bytes (1M bits)
	16 bits/dot	2048 colors, 32,768 colors	256K bytes (2M bits)
	32 bits/dot	16,770,000 colors	512K bytes (4M bits)
512 H dots X 512 V dots	4 bits/dot	16 colors	128K bytes (1M bits)
	8 bits/dot	256 colors	256K bytes (2M bits)
	16 bits/dot	2048 colors, 32,768 colors	512K bytes (4M bits)
	32 bits/dot	16,770,000 colors	1024K bytes (8M bits)
1024 H dots X 256 V dots	4 bits/dot	16 colors	128K bytes (1M bits)
	8 bits/dot	256 colors	256K bytes (2M bits)
	16 bits/dot	2048 colors, 32,768 colors	512K bytes (4M bits)
	32 bits/dot	16,770,000 colors	1024K bytes (8M bits)
1024 H dots X 512 V dots	4 bits/dot	16 colors	256K bytes (2M bits)
	8 bits/dot	256 colors	512K bytes (4M bits)
	16 bits/dot	2048 colors, 32,768 colors	1024K bytes (8M bits)





## • Bitmap Pattern

- (1) Bt map Size : 512 H dds X 256 V dds  
 Bt map Cobr Count : 4 bits/dd (16 colors)

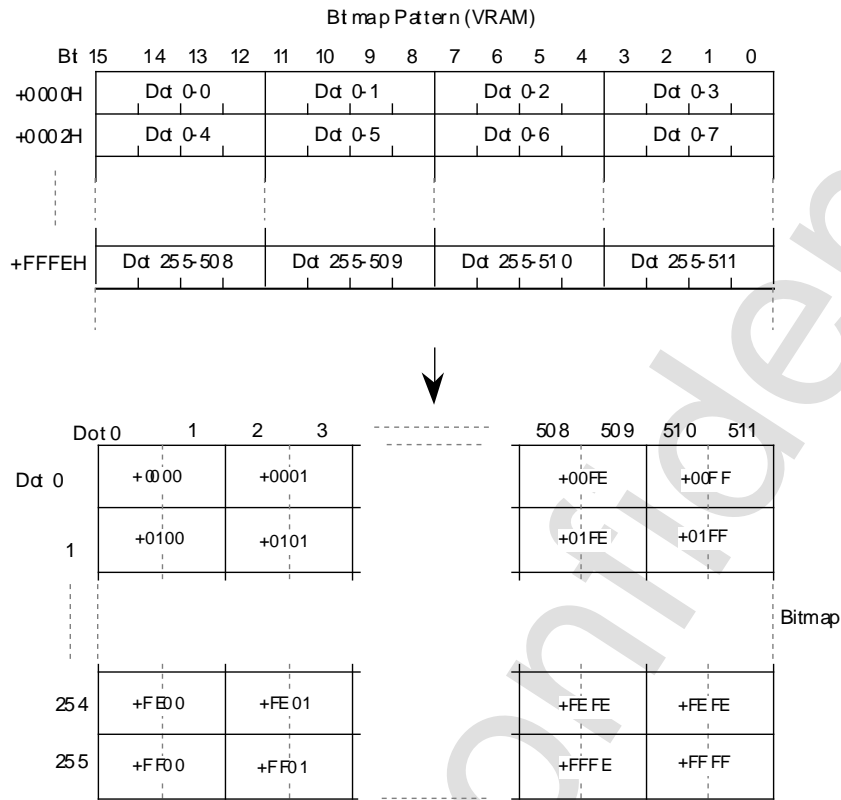

Note 1: The upper left notation in the cell is dot 0-0; to the right are dot 0-1, dot 0-2, dot 0-3, ...

Note 2: Numbers in the cells are VRAM addresses (hexadecimal) of dot (2 dots) data with VRAM address of dot 0-0, 0-1 data as the reference.

## Bitmap Pattern (Continued)

(2) Bitmap Size : 512 H dots X 256 V dots  
 Bitmap Color Count : 8 bits/dot (256 colors)

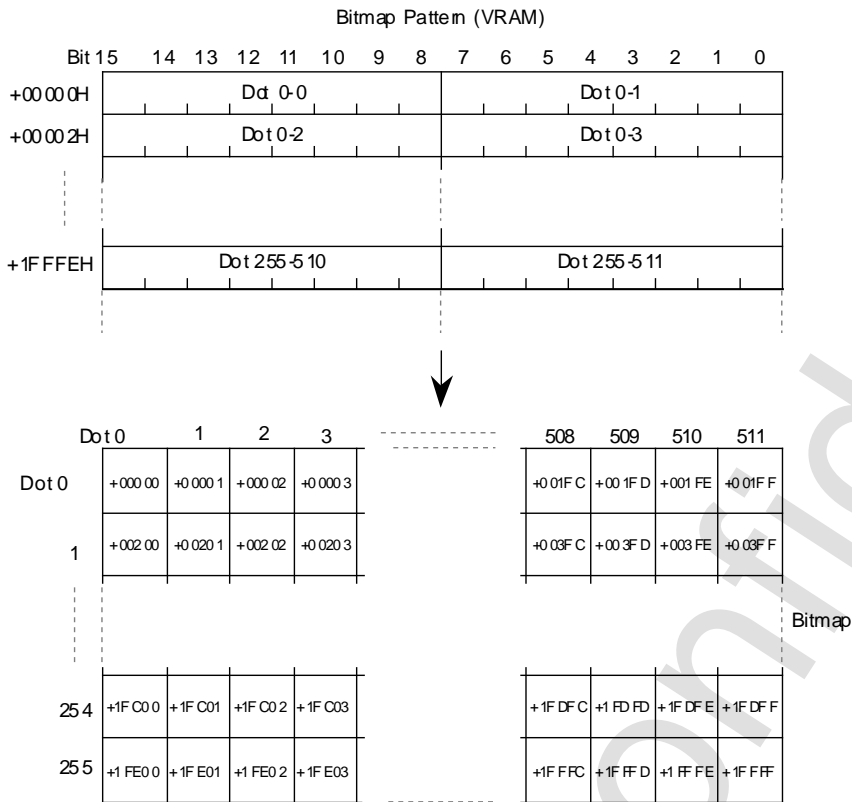

Note 1: The upper left notation in the cell is dot 0-0; to the right are dot 0-1, dot 0-2, dot 0-3, ...

Note 2: Numbers in the cells are VRAM addresses (hexadecimal) of dot data, with VRAM address of dot 0-0 data as the reference.



• **Bitmap Pattern (Continued)**

(3) Bt map Size : 512 H dds X 256 V dds  
 Bt map Cobr Count : 16 bits/ dot (2048 colors, 32768 colors)

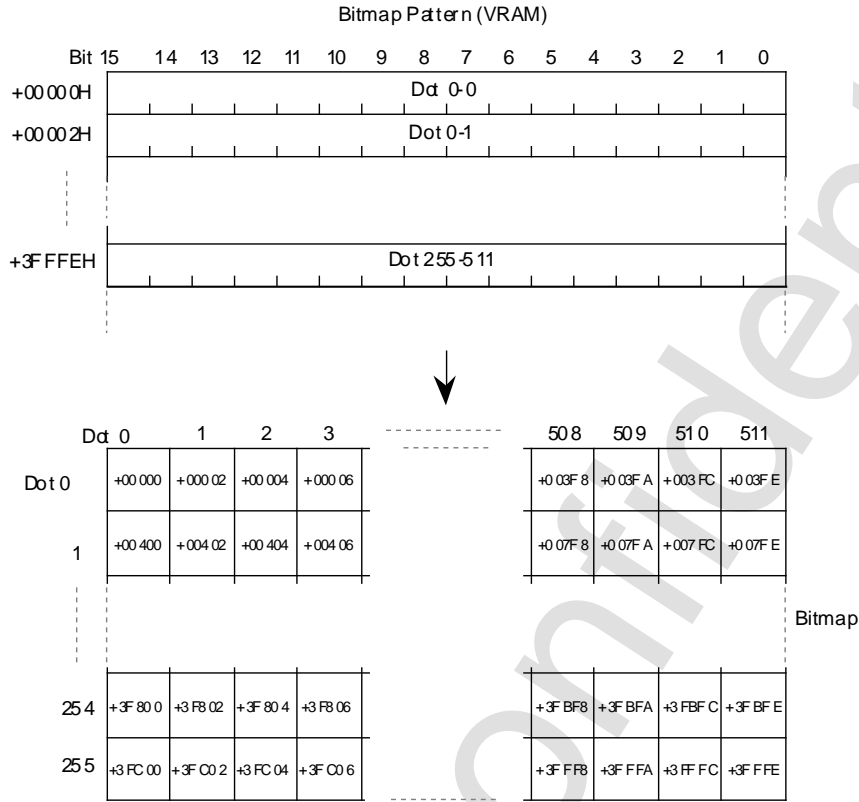

Note 1: The upper left notation in the cell is dot 0-0, to the right are dot 0-1, dot 0-2, dot 0-3, ...

Note 2: Numbers in the cells are VRAM addresses (hexadecimal) of dot data, with VRAM address of dot 0-0 data as the reference.

SEGA

## • Bitmap Pattern (Continued)

(4) Bitmap Size : 512 H dots X 256 V dots  
 Bitmap Color Count : 32 bits/dot (16,777,216 colors)

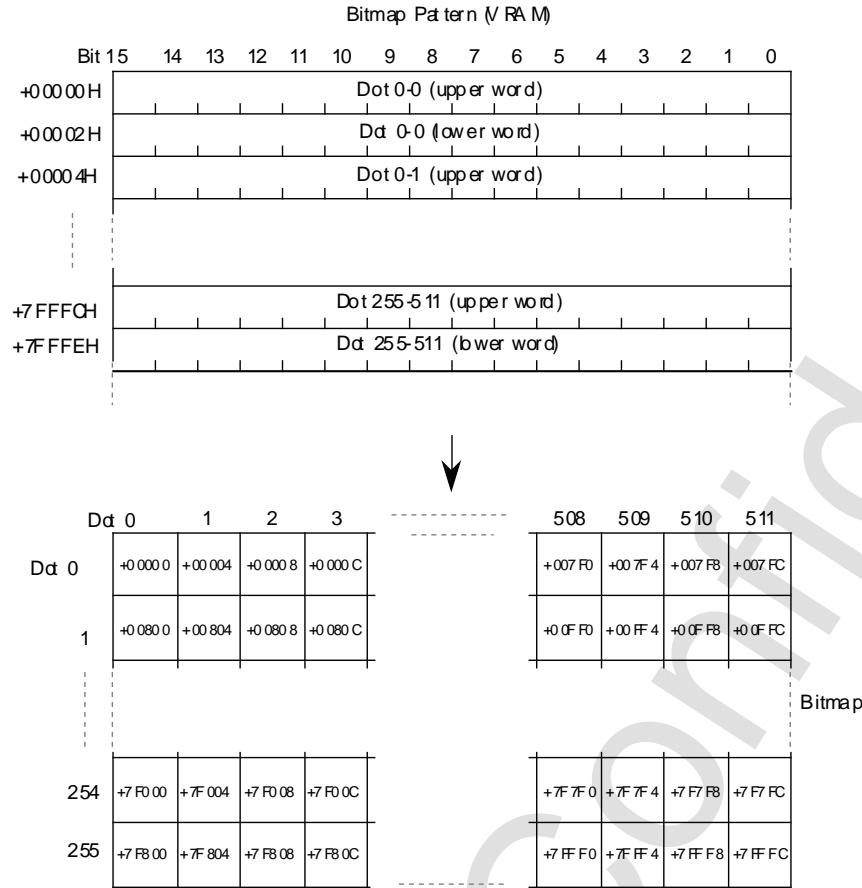

- Note 1: The upper left notation in the cell is dot 0-0; to the right are dot 0-1, dot 0-2, dot 0-3, ...
- Note 2: Numbers in the cells are VRAM addresses (hexadecimal) of dot data (upper word), with VRAM address of dot 0-0 data (upper word) as the reference.



• **Bitmap Pattern (Continued)**

(5) Bitmap Size : 512 H dots X 512 V dots  
 Bitmap Color Count : 4 bit/dot (16 colors)

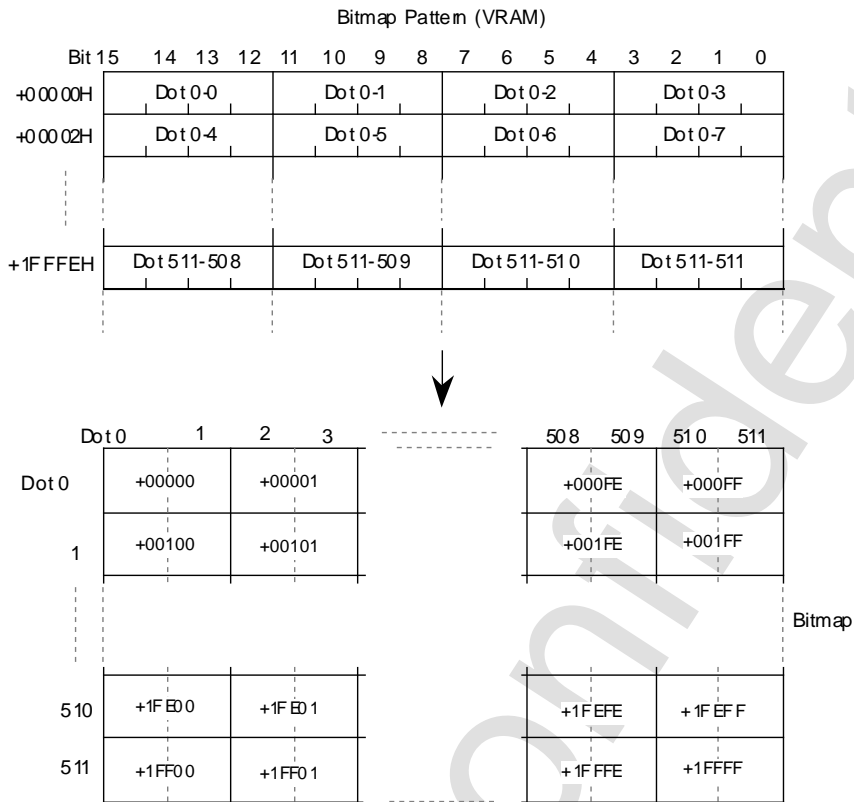

Note 1: The upper left notation in the cell is dot 0-0, to the right are dot 0-1, dot 0-2, dot 0-3, ...

Note 2: Numbers in the cells are VRAM addresses (hexadecimal) of dot (2 dots) data, with VRAM address of dot 0-0, 0-1 data as the reference.

## • Bitmap Pattern (Continued)

(6) Bitmap Size : 512 H dots X 512 V dots  
 Bitmap Color Count : 8 bits/dot (256 colors)

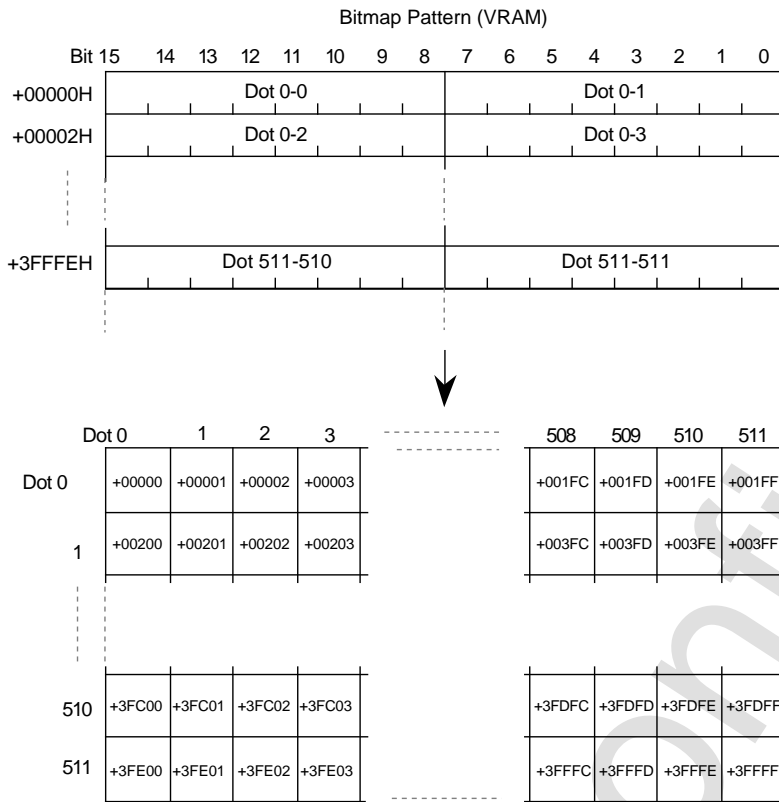

Note 1: The upper left notation in the cell is dot 0-0; to the right are dot 0-1, dot 0-2, dot 0-3, ...

Note 2: Numbers in the cells are VRAM addresses (hexadecimal) of dot data, with VRAM address of dot 0-0 data as the reference.



• **Bitmap Pattern (Continued)**

(7) Bitmap Size : 512 H dots X 512 V dots  
 Bitmap Color Count : 16 bits/dot (2048 colors, 32768 colors)

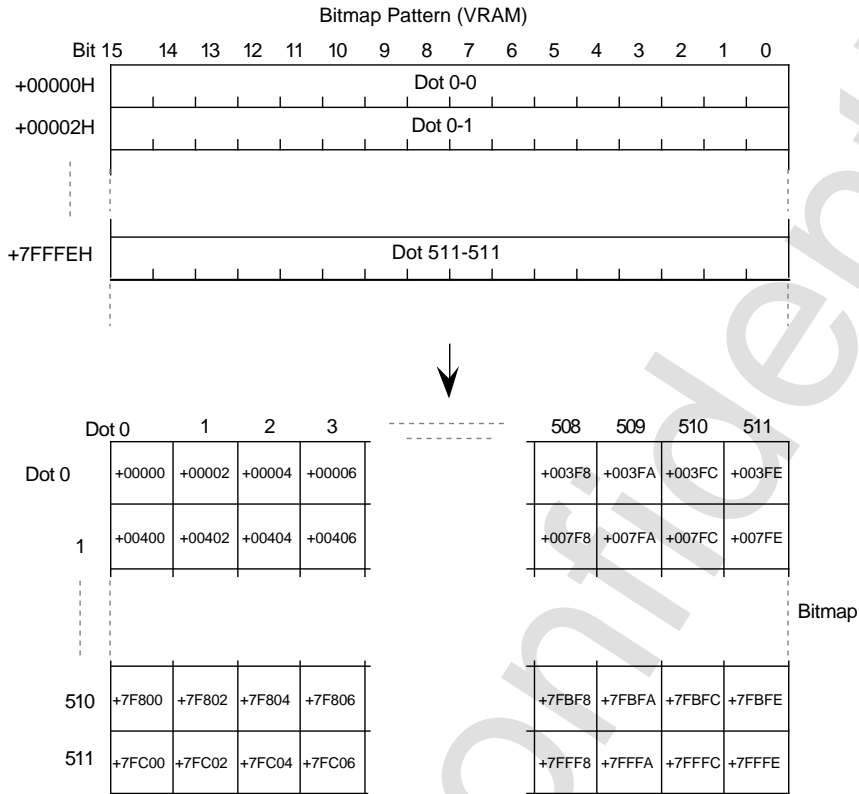

Note 1: The upper left notation in the cell is dot 0-0; to the right are dot 0-1, dot 0-2, dot 0-3, ...

Note 2: Numbers in the cells are VRAM addresses (hexadecimal) of dot data, with VRAM address of dot 0-0 data as the reference.

SEGA Confidential

## • Bitmap Pattern (Continued)

(8) Bitmap Size : 512 H dots X 512 V dots  
 Bitmap Color Count : 32 bits/dot (16,770,000 colors)

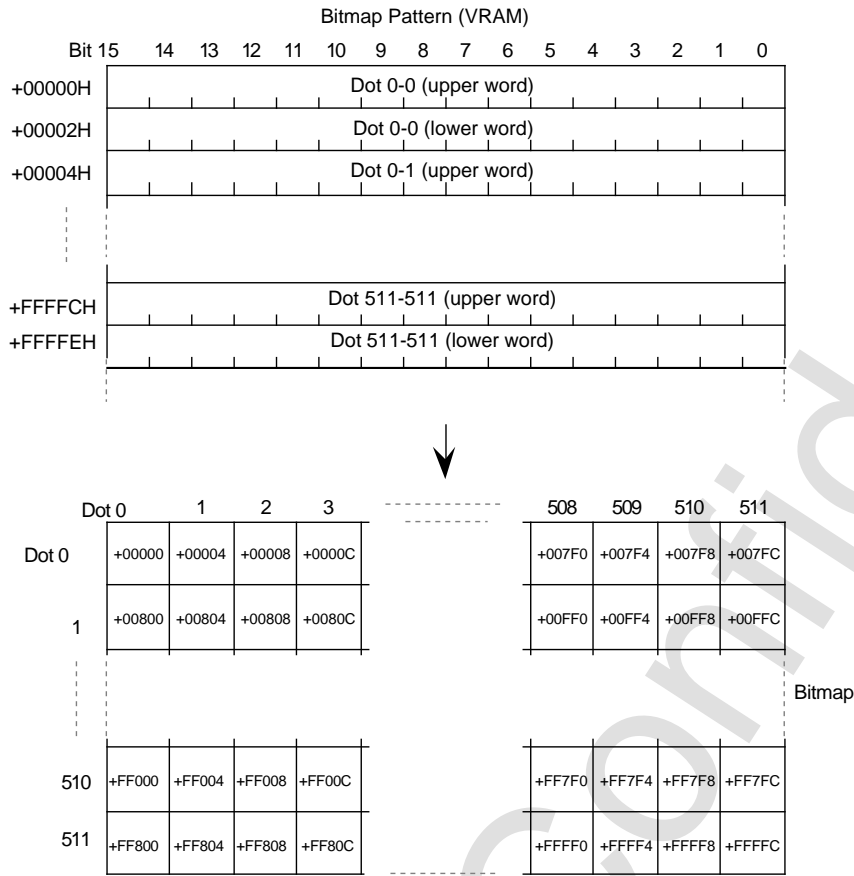

Note 1: The upper left notation in the cell is dot 0-0; to the right are dot 0-1, dot 0-2, dot 0-3, ...

Note 2: Numbers in the cells are VRAM addresses (hexadecimal) of dot data (upper word), with VRAM address of dot 0-0 data (upper word) as the reference.





• **Bitmap Pattern (Continued)**

(9) Bitmap Size : 1024 H dots X 256 V dots  
 Bitmap Color Count : 4 bits/dot (16 colors)

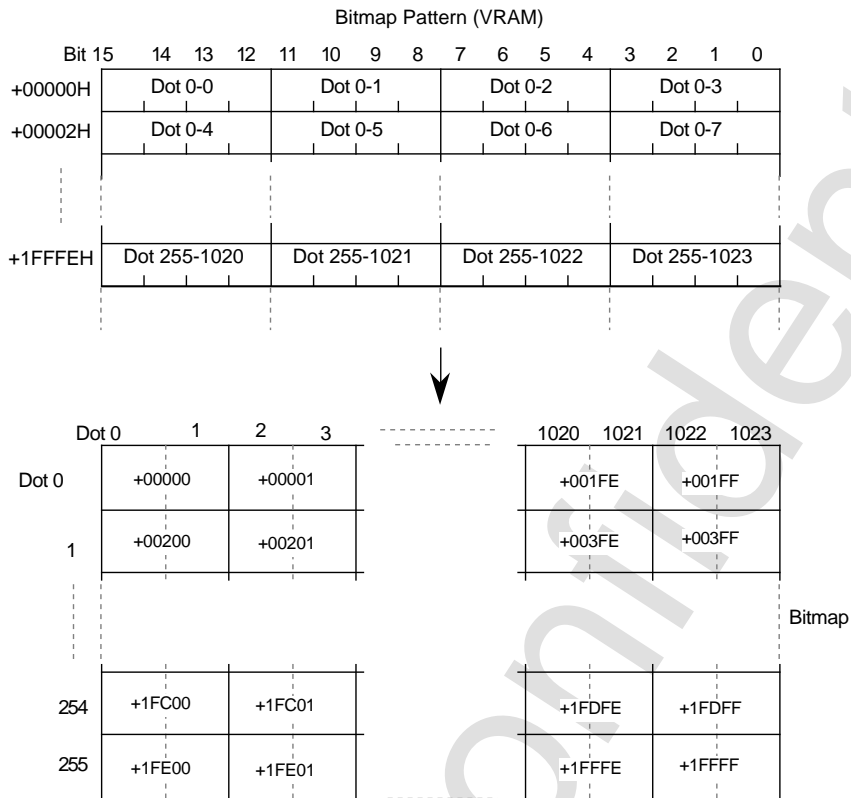

Note 1: The upper left notation in the cell is dot 0-0; to the right are dot 0-1, dot 0-2, dot 0-3, ...

Note 2: Numbers in the cells are VRAM addresses (hexadecimal) of dot (2 dots) data, with VRAM address of dot 0-0, 0-1 data as the reference.

SEGA Confidential

## • Bitmap Pattern (Continued)

(10) Bitmap Size : 1024 H dots X 256 V dots  
 Bitmap Color Count : 8 bits/dot (256 colors)

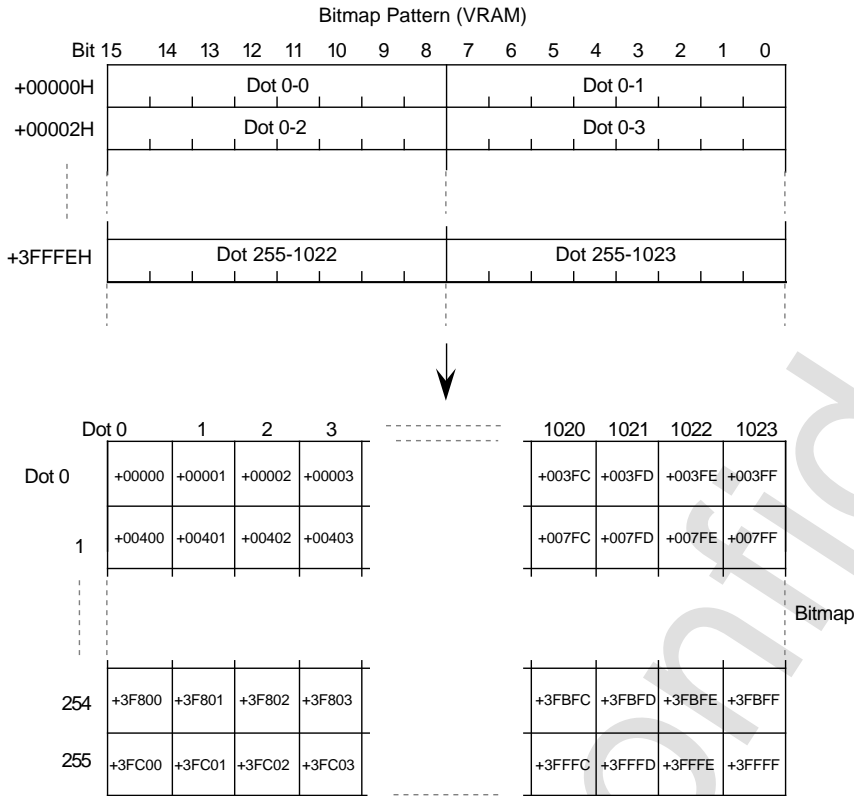

Note 1: The upper left notation in the cell is dot 0-0; to the right are dot 0-1, dot 0-2, dot 0-3, ...

Note 2: Numbers in the cells are VRAM addresses (hexadecimal) of dot data, with VRAM address of dot 0-0 data as the reference.



• **Bitmap Pattern (Continued)**

(11) Bitmap Size : 1024 H dots X 256 V dots  
 Bitmap Color Count : 16 bits/dot (2048 colors, 32768 colors)

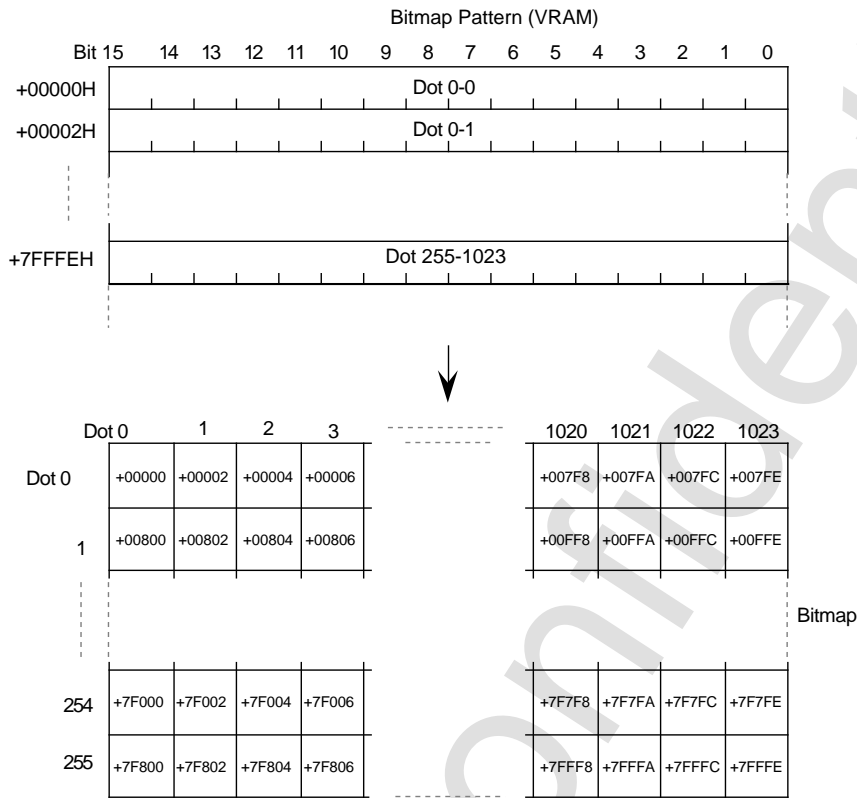

Note 1: The upper left notation in the cell is dot 0-0; to the right are dot 0-1, dot 0-2, dot 0-3, ...

Note 2: Numbers in the cells are VRAM addresses (hexadecimal) of dot data, with VRAM address of dot 0-0 data as the reference.

## • Bitmap Pattern (Continued)

(12) Bitmap Size : 1024 H dots X 256 V dots  
 Bitmap Color Count : 32 bits/dot (16,770,000 colors)

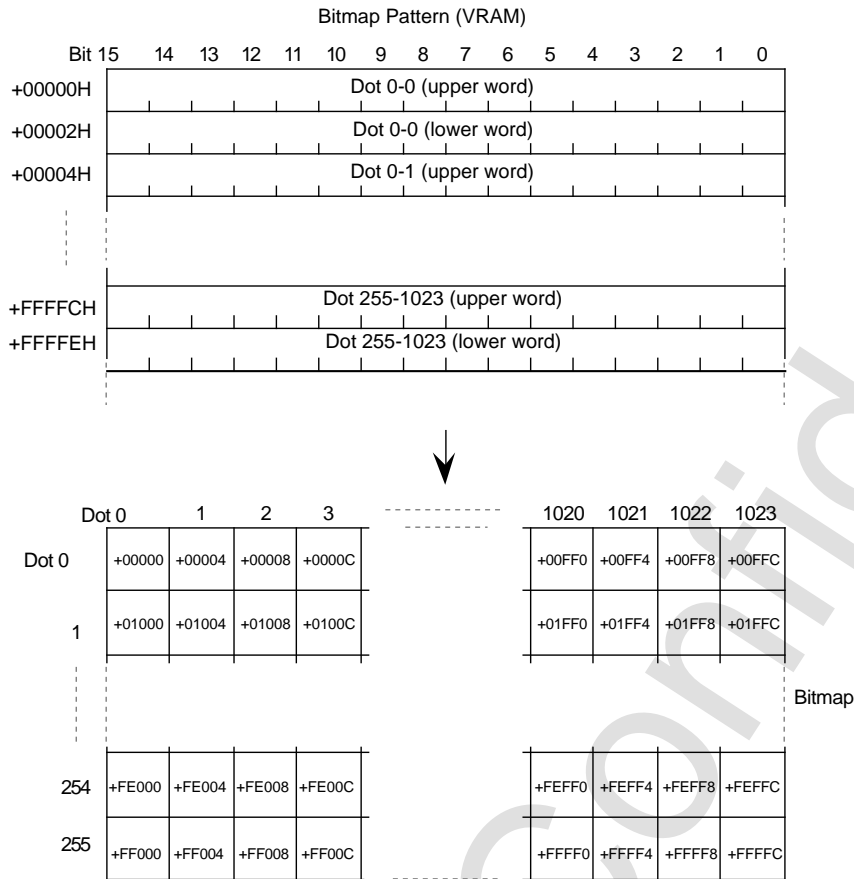

Note 1: The upper left notation in the cell is dot 0-0; to the right are dot 0-1, dot 0-2, dot 0-3, ...

Note 2: Numbers in the cells are VRAM addresses (hexadecimal) of dot data (upper word), with VRAM address of dot 0-0 data (upper word) as the reference.



• **Bitmap Pattern (Continued)**

(13) Bitmap Size : 1024 H dots X 512 V dots  
 Bitmap Color Count : 4 bits/dot (16 colors)

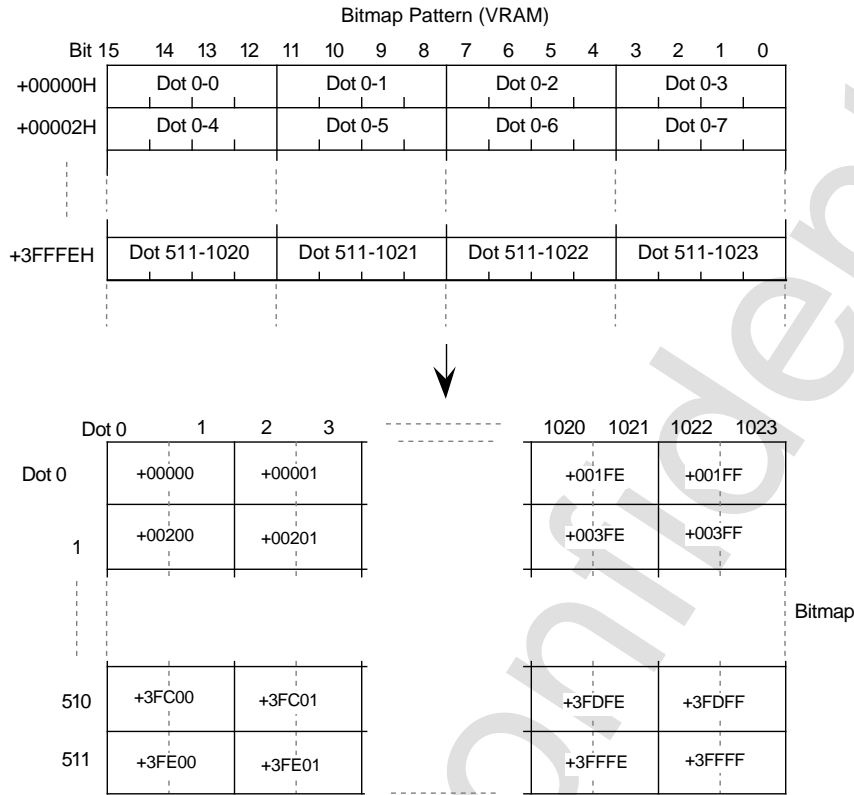

- Note 1: The upper left notation in the cell is dot 0-0; to the right are dot 0-1, dot 0-2, dot 0-3, ...
- Note 2: Numbers in the cells are VRAM addresses (hexadecimal) of dot (2 dots) data, with VRAM address of dot 0-0, 0-1 data as the reference.

SEGA Confidential

• **Bitmap Pattern (Continued)**

(14) Bitmap Size : 1024 H dots X 512 V dots  
 Bitmap Color Count : 8 bits/dot (256 colors)

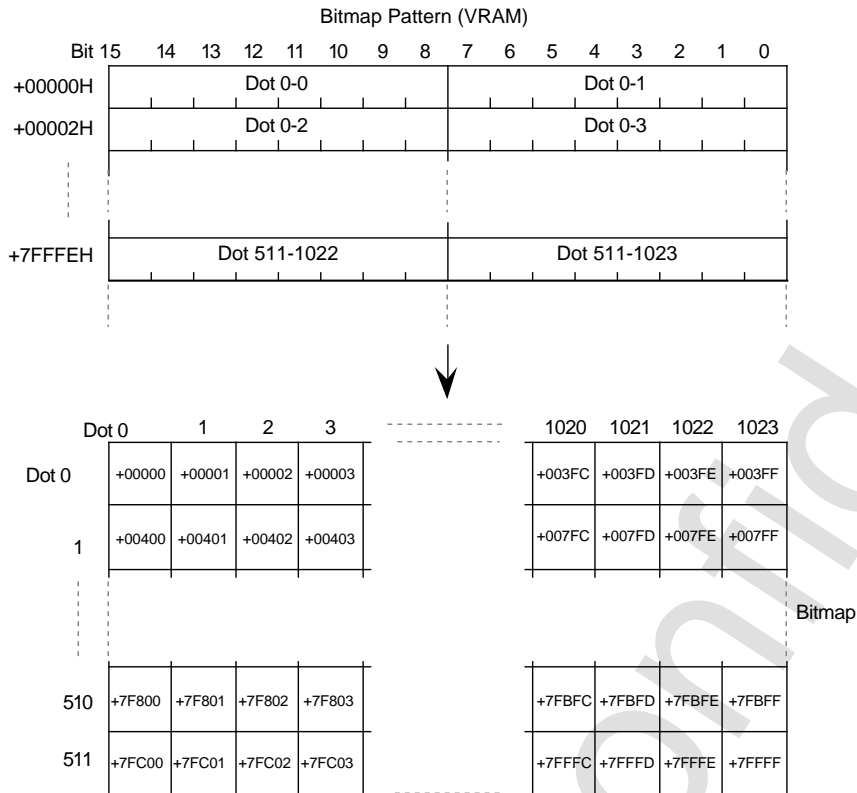

Note 1: The upper left notation in the cell is dot 0-0; to the right are dot 0-1, dot 0-2, dot 0-3, ...

Note 2: Numbers in the cells are VRAM addresses (hexadecimal) of dot data, with VRAM address of dot 0-0 data as the reference.



## • Bitmap Pattern (Continued)

(15) Bitmap Size : 1024 H dots X 512 V dots  
 Bitmap Color Count : 16 bits/dot (2048 colors, 32768 colors)

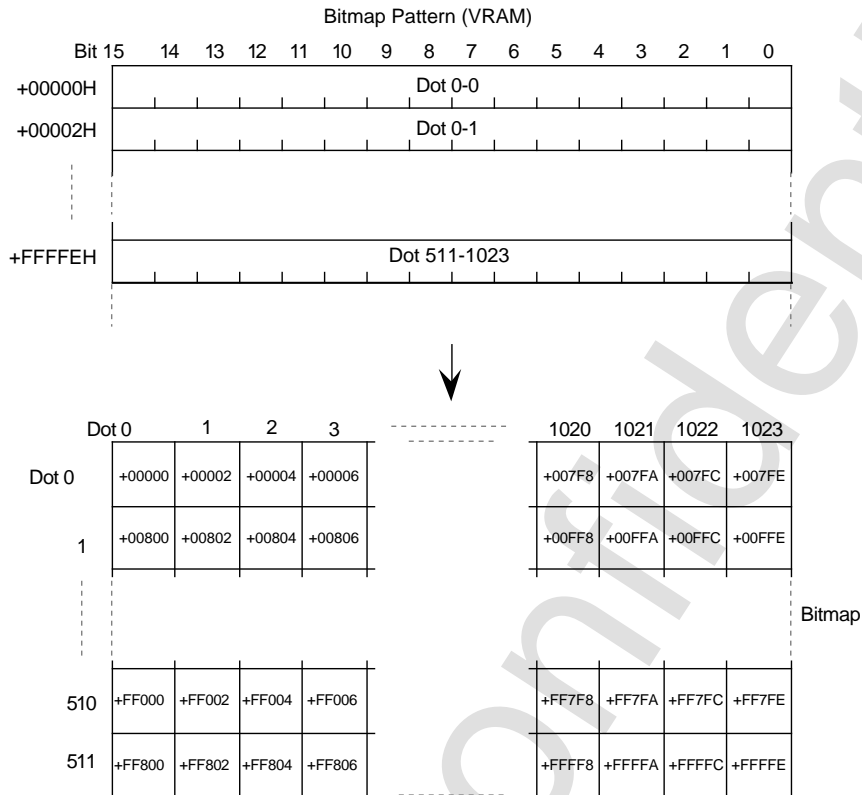

Note 1: The upper left notation in the cell is dot 0-0; to the right are dot 0-1, dot 0-2, dot 0-3, ...

Note 2: Numbers in the cells are VRAM addresses (hexadecimal) of dot data, with VRAM address of dot 0-0 data as the reference.

## • Line Scroll Table Data Bit Configuration

Horizontal, Vertical Screen Scroll Value

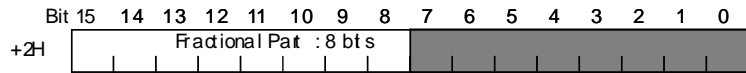
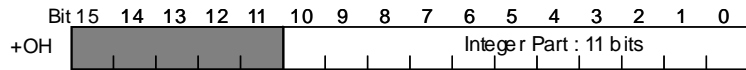

Horizontal Coordinate Increment

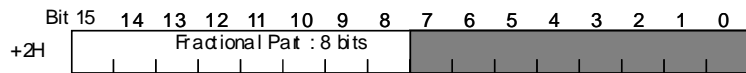

Note: Shaded areas are ignored





## • Example of Line Scroll Table

When selecting horizontal and vertical screen scroll values and horizontal coordinate increment for every 1 line.

		Bit 15	Line Scroll Table (VRAM)	0
Line Scroll Table Address	→ +00H		Line 1 Horiz. Screen Scroll Value (Integer Part)	
	+02H		Line 1 Horiz. Screen Scroll Value (Fractional Part)	
	+04H		Line 1 Vertical Screen Scroll Value (Integer Part)	
	+06H		Line 1 Vertical Screen Scroll Value (Fractional Part)	
	+08H		Line 1 Horiz. Coordinate Increment (Integer Part)	
	+0AH		Line 1 Horiz. Coordinate Increment (Fractional Part)	
	+0CH		Line 2 Horiz. Screen Scroll Value (Integer Part)	
	+0EH		Line 2 Horiz. Screen Scroll Value (Fractional Part)	
	+10H		Line 2 Vertical Screen Scroll Value (Integer Part)	
	+12H		Line 2 Vertical Screen Scroll Value (Fractional Part)	
	+14H		Line 2 Horiz. Coordinate Increment (Integer Part)	
	+16H		Line 2 Horiz. Coordinate Increment (Fractional Part)	

When selecting vertical screen scroll value and horizontal coordinate increment for every 2 lines (no horizontal line scroll).

		Bit 15	Line Scroll Table (VRAM)	0
Line Scroll Table Address	→ +00H		Line 1 Vertical Screen Scroll Value (Integer Part)	
	+02H		Line 1 Vertical Screen Scroll Value (Fractional Part)	
	+04H		Line 1, 2 Horiz. Coordinate Increment (Integer Part)	
	+06H		Line 1, 2 Horiz. Coordinate Increment (Fractional Part)	
	+08H		Line 3 Vertical Screen Scroll Value (Integer Part)	
	+0AH		Line 3 Vertical Screen Scroll Value (Fractional Part)	
	+0CH		Line 3, 4 Horiz. Coordinate Increment (Integer Part)	
	+0EH		Line 3, 4 Horiz. Coordinate Increment (Fractional Part)	

Note: Display coordinates in the vertical direction for lines not specified are obtained by adding coordinate increments in the vertical direction to the vertical screen scroll values for the lines specified.

When selecting horizontal screen scroll value and horizontal coordinate increment for every 4 lines (no horizontal line scroll).

		Bit 15	Line Scroll Table (VRAM)	0
Line Scroll Table Address	→ +00H		Line 1~4 Horiz. Screen Scroll Value (Integer Part)	
	+02H		Line 1~4 Horiz. Screen Scroll Value (Fractional Part)	
	+04H		Line 1~4 Horiz. Coordinate Increment (Integer Part)	
	+06H		Line 1~4 Horiz. Coordinate Increment (Fractional Part)	
	+08H		Line 5~8 Horiz. Screen Scroll Value (Integer Part)	
	+0AH		Line 5~8 Horiz. Screen Scroll Value (Fractional Part)	
	+0CH		Line 5~8 Lines Horiz. Coordinate Increment (Integer Part)	
	+0EH		Line 5~8 Lines Horiz. Coordinate Increment (Fractional Part)	

### • Vertical Cell Scroll Table Data Bit Configuration

Vertical Screen Scroll Value

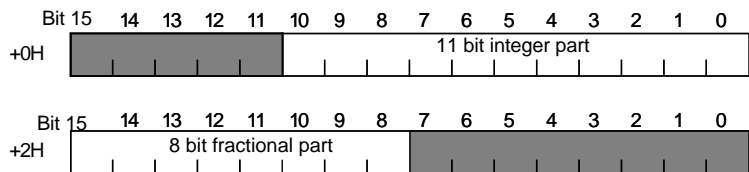

Note: Shaded area is ignored

SEGA Confidential



## • Example of Vertical Cell Scroll Table

NBG0 Vertical Cell Scroll

		Bit 15	Vertical Cell Scroll Table (VRAM)	0
Vertical Cell Scroll Table Address →	+00H		NBG0 1st cell vertical screen scroll value (integer part)	
	+02H		NBG0 1st cell vertical screen scroll value (fractional part)	
	+04H		NBG0 2nd cell vertical screen scroll value (integer part)	
	+06H		NBG0 2nd cell vertical screen scroll value (fractional part)	
	+08H		NBG0 3rd cell vertical screen scroll value (integer part)	
	+0AH		NBG0 3rd cell vertical screen scroll value (fractional part)	
	+0CH		NBG0 4th cell vertical screen scroll value (integer part)	
	+0EH		NBG0 4th cell vertical screen scroll value (fractional part)	
	+10H		NBG0 5th cell vertical screen scroll value (integer part)	
	+12H		NBG0 5th cell vertical screen scroll value (fractional part)	

NBG1 Vertical Cell Scroll

		Bit 15	Vertical Cell Scroll Table (VRAM)	0
Vertical Cell Scroll Table Address →	+00H		NBG1 1st cell vertical screen scroll value (integer part)	
	+02H		NBG1 1st cell vertical screen scroll value (fractional part)	
	+04H		NBG1 2nd cell vertical screen scroll value (integer part)	
	+06H		NBG1 2nd cell vertical screen scroll value (fractional part)	
	+08H		NBG1 3rd cell vertical screen scroll value (integer part)	
	+0AH		NBG1 3rd cell vertical screen scroll value (fractional part)	
	+0CH		NBG1 4th cell vertical screen scroll value (integer part)	
	+0EH		NBG1 4th cell vertical screen scroll value (fractional part)	
	+10H		NBG1 5th cell vertical screen scroll value (integer part)	
	+12H		NBG1 5th cell vertical screen scroll value (fractional part)	

NBG0 and NBG1 Vertical Cell Scroll

		Bit 15	Vertical Cell Scroll Table (VRAM)	0
Vertical Cell Scroll Table Address →	+00H		NBG0 1st cell vertical screen scroll value (integer part)	
	+02H		NBG0 1st cell vertical screen scroll value (fractional part)	
	+04H		NBG1 1st cell vertical screen scroll value (integer part)	
	+06H		NBG1 1st cell vertical screen scroll value (fractional part)	
	+08H		NBG0 2nd cell vertical screen scroll value (integer part)	
	+0AH		NBG0 2nd cell vertical screen scroll value (fractional part)	
	+0CH		NBG1 2nd cell vertical screen scroll value (integer part)	
	+0EH		NBG1 2nd cell vertical screen scroll value (fractional part)	
	+10H		NBG0 3rd cell vertical screen scroll value (integer part)	
	+12H		NBG0 3rd cell vertical screen scroll value (fractional part)	

## • Rotation Parameter Table

+00H	Screen Start Coordinate Xst	(Integer Part)
+02H		(Fractional Part)
+04H	Screen Start Coordinate Yst	(Integer Part)
+06H		(Fractional Part)
+08H	Screen Start Coordinate Zst	(Integer Part)
+0AH		(Fractional Part)
+0CH	Screen Vertical Coordinate Increment $\Delta Xst$	(Integer Part)
+0EH		(Fractional Part)
+10H	Screen Vertical Coordinate Increment $\Delta Yst$	(Integer Part)
+12H		(Fractional Part)
+14H	Screen Horiz. Coordinate Increment $\Delta X$	(Integer Part)
+16H		(Fractional Part)
+18H	Screen Horiz. Coordinate Increment $\Delta Y$	(Integer Part)
+1AH		(Fractional Part)
+1CH	Rotation Matrix Parameter A	(Integer Part)
+1EH		(Fractional Part)
+20H	Rotation Matrix Parameter B	(Integer Part)
+22H		(Fractional Part)
+24H	Rotation Matrix Parameter C	(Integer Part)
+26H		(Fractional Part)
+28H	Rotation Matrix Parameter D	(Integer Part)
+2AH		(Fractional Part)
+2CH	Rotation Matrix Parameter E	(Integer Part)
+2EH		(Fractional Part)
+30H	Rotation Matrix Parameter F	(Integer Part)
+32H		(Fractional Part)
+34H	Viewpoint Coordinate Px	(Integer Part)
+36H	Viewpoint Coordinate Py	(Integer Part)
+38H	Viewpoint Coordinate Pz	(Integer Part)
+3AH	This data is ignored	
+3CH	Center Point Coordinate Cx	(Integer Part)
+3EH	Center Point Coordinate Cy	(Integer Part)
+40H	Center Point Coordinate Cz	(Integer Part)
+42H	This data is ignored	
+44H	Horizontal Shift Mx	(Integer Part)
+46H		(Fractional Part)
+48H	Horizontal Shift My	(Integer Part)
+4AH		(Fractional Part)
+4CH	Scaling Coefficient kx	(Integer Part)
+4EH		(Fractional Part)
+50H	Scaling Coefficient ky	(Integer Part)
+52H		(Fractional Part)
+54H	Coefficient Table Start Address KAst	(Integer Part)
+56H		(Fractional Part)
+58H	Coefficient Table Vertical Address Increment $\Delta KAst$	(Integer Part)
+5AH		(Fractional Part)
+5CH	Coefficient Table Horiz. Address Increment $\Delta KAx$	(Integer Part)
+5EH		(Fractional Part)



- Mode 0: Used as Scale Coefficients  $k_x$  and  $k_y$
- Mode 1: Used as Scale Coefficients coefficient  $k_x$
- Mode 2: Used as Scale Coefficients coefficient  $k_y$
- Mode 3: Used as viewpoint coordinate  $X_p$  after rotation conversion

• **Coefficient Table Data Bit Configuration**

Coefficient Data Mode 0-2

Coefficient Data Size: 2 words

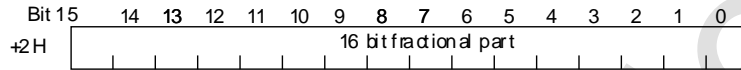
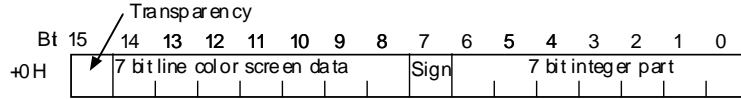

Coefficient Data Size: 1 word

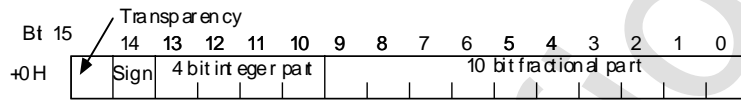

Note: The MSB are sign-expanded by 3 bits and the LSB are 0-expanded by 6 bits to be of equal to the number of bits as in the case of 2 words.

Coefficient Data Mode 3

Coefficient Data Size: 2 words

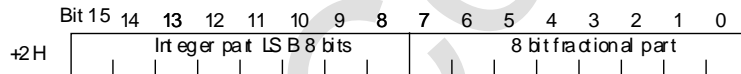
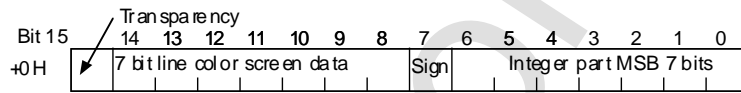

Coefficient Data Size: 1 word

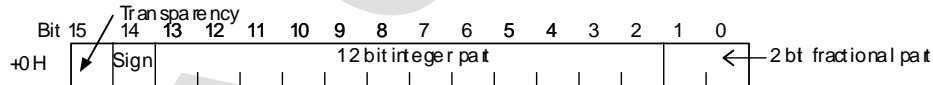

Note: The MSB are sign-expanded by 3 bits and the LSB are 0-expanded by 6 bits to be of equal to the number of bits as in the case of 2 words.

## • Line Color Screen Table Data Bit Configuration

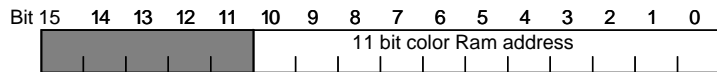

Note: Shaded are is ignored. Also, when color RAM is in mode 0 or mode 2, the MSB of the address is ignored.

## • Line Color Screen Table

Non-interlace and double-density interlace mode

Bit 15	Line Color Screen Table (VRAM)	0
+00H	1st Line Color RAM Address	
+02H	2nd Line Color RAM Address	
+04H	3rd Line Color RAM Address	
+06H	4th Line Color RAM Address	
+08H	5th Line Color RAM Address	
+0AH	6th Line Color RAM Address	

Note: In the case of single color, the 1st line color RAM address is used in the entire line color screen. In the case of double-density interlace, line data of odd and even fields are stored together.

Single-density interlace mode

Bit 15	Line Color Screen Table (VRAM)	0
+00H	1st and 2nd Line Color Ram Address	
+02H	3rd and 4th Line Color Ram Address	
+04H	5th and 6th Line Color Ram Address	
+06H	7th and 8th Line Color Ram Address	
+08H	9th and 10th Line Color Ram Address	
+0AH	11th and 12th Line Color Ram Address	

Note: In the case of single color, the 1st and 2nd line color RAM addresses are used in the entire line color screen.



## • Back Screen Table Data Bit Configuration

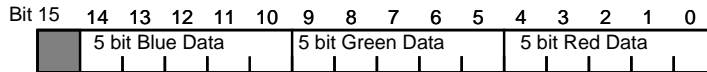

Note: Shaded area is ignored. Add 0 bit 3 bits at a time to the lower bits of RGB to make 8 bits.

## • Back Screen Table

Non-interlace and double-density interlace mode

Bit 15	Back Screen Table (VRAM)	0
+00H	1st Line RGB Data	
+02H	2nd Line RGB Data	
+04H	3rd Line RGB Data	
+06H	4th Line RGB Data	
+08H	5th Line RGB Data	
+0AH	6th Line RGB Data	

Note: In the case of single color, the 1st line RGB data is used in the entire line color screen. In the case of double-density interlace, line data of odd and even fields are stored together.

Single-density interlace mode

Bit 15	Back Screen Table (VRAM)	0
+00H	1st and 2nd Line RGB Data	
+02H	3rd and 4th Line RGB Data	
+04H	5th and 6th Line RGB Data	
+06H	7th and 8th Line RGB Data	
+08H	9th and 10th Line RGB Data	
+0AH	11th and 12th Line RGB Data	

Note: In the case of single color, the 1st and 2nd line RGB data are used in the entire line color screen.

## • Normal Line Window Table Data Bit Configuration

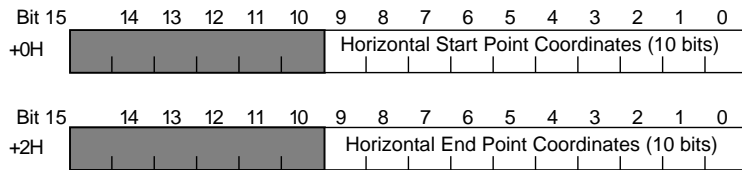

Note: Shaded areas are ignored

## • Normal Line Window Table

Non-interlace or double-density interlace

Bit 15	Line Window Table (VRAM)	0
+00H	1st line horizontal start point coordinates	
+02H	1st line horizontal end point coordinates	
+04H	2nd line horizontal start point coordinates	
+06H	2nd line horizontal end point coordinates	
+08H	3rd line horizontal start point coordinates	
+0AH	3rd line horizontal end point coordinates	

Note: In the case of double-density interlace, store line data of both even and odd fields.

Single-density interlace

Bit 15	Line Window Table (VRAM)	0
+00H	1st & 2nd line horizontal start point coordinates	
+02H	1st & 2nd line horizontal end point coordinates	
+04H	3rd & 4th line horizontal start point coordinates	
+06H	3rd & 4th line horizontal end point coordinates	
+08H	5th & 6th line horizontal start point coordinates	
+0AH	5th & 6th line horizontal end point coordinates	

